



MONOXOR[®] PLUS

Carbon Monoxide Analyzer Configuration and Operation Manual



 **MICROWATT**
Making Safety Work

Tollfree in Western Canada: 1-888-388-1592
microwatt.com • mwsales@microwatt.com

SALES • SERVICE • SUPPORT

Instruction 0019-9370

Rev 1

October 2014

Product Leadership • Training • Service • Reliability

WARRANTY POLICY

Bacharach, Inc. (Bacharach) warrants to the buyer that this product will be free from material defects, free from manufacturing defects, and will conform substantially to Bacharach's applicable specifications at the time of delivery.

Bacharach's liability and the buyer's remedy under this warranty are limited to the repair or replacement, at Bacharach's option, of this product or parts thereof returned to Bacharach and shown to Bacharach's reasonable satisfaction to have been defective; provided that written notice of the defect is given by buyer to Bacharach within two (2) years after the date of delivery of this Product by Bacharach.

Bacharach warrants to the buyer that Bacharach will convey good title to this product. Bacharach's liability and the buyer's remedy under this warranty of title are limited to: the removal of any title defects or, at the election of Bacharach, the replacement of this product or parts thereof that are defective in title.

The foregoing warranties are exclusive and are given and accepted in lieu of (I) any and all other warranties, express or implied, including without limitation the implied warranties of merchantability and fitness for a particular purpose: and (II) any obligation, liability, right, claim or remedy in contract or tort, whether or not arising from Bacharach's negligence, actual or implied. The remedies of the buyer shall be limited to those provided herein to the exclusion of any and all other remedies including, without limitation incidental or consequential damages. No agreement varying or extending the foregoing warranties, remedies or this limitation will be binding upon Bacharach unless in writing and signed by a duly authorized officer of Bacharach.

**Register your warranty by visiting
www.MyBacharach.com**

NOTICE

Product improvements and enhancements are continuous; therefore the specifications and information contained in this document may change without notice.

Bacharach, Inc. shall not be liable for errors contained herein or for incidental or consequential damages in connection with the furnishing, performance, or use of this material.

No part of this document may be photocopied, reproduced, or translated to another language without the prior written consent of Bacharach, Inc.

Copyright © 2014, Bacharach, Inc., all rights reserved.

BACHARACH, Fyrite, True Spot, Monoxor, and B-SMART are registered trademarks of Bacharach, Inc. All other trademarks, trade names, service marks and logos referenced herein belong to their respective companies.

Table of Contents

Section 1.	Overview	1
1.1.	Introduction	1
1.2.	Conventions.....	1
1.3.	Safety.....	1
1.4.	Product Overview.....	2
1.5.	Components	6
1.6.	Features.....	8
1.7.	Monoxor [®] Plus Sales Combinations	9
1.8.	Specifications.....	9
Section 2.	Setup.....	11
2.1.	Connecting the Probe.....	11
2.2.	Front Panel Buttons.....	12
2.3.	Power Options.....	13
2.4.	Turning On the Monoxor [®] Plus	14
Section 3.	Configuration	15
3.1.	Menu Structure Overview	15
3.2.	The Warm-up Sequence	15
3.3.	Main Menu	16
3.4.	Ambient CO Menu.....	17
3.5.	Differential Temperature Menu	18
3.6.	Memory Options Menu	19
3.7.	Setup Menu	20
3.8.	Calibration Menu.....	28
3.9.	Diagnostics Menu	29
3.10.	Status Menu	30
Section 4.	Operation.....	31
4.1.	Overview	31
4.2.	Taking a Gas Sample	31
4.3.	The RUN and Hold Screens.....	32
4.4.	CO Trending Graph	33
4.5.	Ending a Test	33
4.6.	Taking Differential Temperature Measurements.....	34
4.7.	Timed Ambient CO Testing.....	35
4.8.	Printing Using the Optional IrDA Printer	36
4.9.	Turning Off the Analyzer	38

4.10. PC Interface and Fyrite® User Software 38

Section 5. Calibration and Maintenance 39

5.1. Serviceability 39

5.2. Cleaning the Probe 39

5.2.1. Equipment Required 40

5.2.2. Procedure 40

5.3. Filter Replacement 41

5.4. CO Sensor Replacement 42

5.4.1. Accessing the CO Sensor 42

5.4.2. Material Required (As Needed) 42

5.4.3. CO Sensor Replacement Procedure 43

5.4.4. B-SMART® CO Sensor Replacement 43

5.5. Temperature Calibration 44

5.5.1. Materials Required 44

5.5.2. Temperature Calibration Procedure 44

5.6. CO Sensor Calibration 46

5.6.1. Materials Required 46

5.6.2. CO Manual Zero Procedure 46

5.6.3. CO Sensor Span Procedure 47

5.7. T-Ref Sensor Calibration 48

Section 6. Troubleshooting 49

6.1. Error and Warning Messages 49

6.2. Replacement Parts 50

6.3. Accessories 50

6.4. Instrument Identification 51

6.5. Service Centers 51

Declaration of Conformity 53



Section 1. Overview

1.1. Introduction

Thank you for investing in a Bacharach Monoxor® Plus carbon monoxide (CO) analyzer. To assure proper use and operator safety, please read the contents of this manual for important information on the operation and maintenance of the analyzer.

1.2. Conventions



WARNING: A warning statement denotes a potential hazard associated with the use of this equipment. Failure to follow this information could result in serious personal injury or death.



CAUTION: A caution statement indicates a potentially hazardous situation which, if not avoided, may result in minor or moderate injury. Caution statements may also be used to alert against unsafe practices.



IMPORTANT: An important statement provides emphasis of an important feature, operation, etc. Failure to follow this information could void your warranty, result in improper operation, or cause equipment damage.



NOTE: A note statement provides emphasis of a feature, operation, practice, etc.

1.3. Safety



WARNING: This analyzer is not intended to be used as a safety device.



WARNING: When testing an appliance, a full visual inspection of the appliance should be performed to ensure its safe operation.



CAUTION: This analyzer is not intended to be used on a continuous basis.



CAUTION: Do not store instrument or its sensors with solvents or products that contain solvents.



CAUTION: Except for sensor and battery replacement, this analyzer should only be opened and/or serviced by authorized Bacharach personnel. Failure to comply may void the warranty.



HAZARDOUS AREA WARNING: This instrument has not been designed to be intrinsically safe for use in areas classified as hazardous locations. For your safety, **DO NOT** use it in hazardous (classified) locations.



CAUTION: Do not use flammable or combustible substances (like carburetor fluid used for cleaning the probe) near an open flame.



CAUTION: When the instrument is used in an inefficient oil-fueled appliance where there is a high emission of soot, the probe's sample filter may become clogged. Before every use check the filter to confirm it is clean or replace it with a new filter.

To prevent soot intake and a clogged filter, a smoke test should be performed before operating under such conditions. This ensures that the furnace or boiler is burning at a level appropriate for the use of this instrument.

1.4. Product Overview

The Monoxor[®] Plus is a portable hand-held carbon monoxide (CO) analyzer for use in residential and light commercial applications. It is intended to be used by:

- HVAC contractors
- home inspectors
- maintenance personnel
- safety inspectors

to detect and display concentrations of CO gas between 0 and 2000 ppm. The analyzer is capable of testing for CO in both ambient room air and in the flue-gas stream of fossil-fuel fired furnaces and boilers. Using the optional appliance kit, you can measure CO levels emitted from fossil-fuel-based appliances such as gas stoves and gas fireplaces.

AMBIENT CO

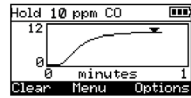
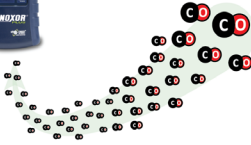

CO gas is colorless, odorless, and deadly. Test CO levels in suspect ambient air. Perform an automated 15-minute test, watch live values, or view a dynamic CO graph over time.

COMBUSTION CO (SHOWN WITH OPTIONAL NO_x FILTER KIT P/N: 0024-1505)

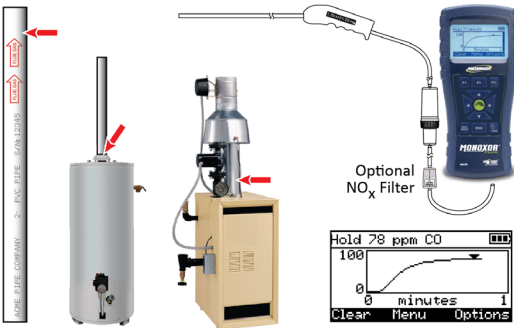

CO levels in flue gas can indicate good or poor combustion. For furnaces, water heaters, and boilers, use CO levels to gauge the effectiveness of the combustion adjustments you make. Lower CO levels mean you're close to the combustion "sweet spot."

APPLIANCE CO USING OPTIONAL APPLIANCE KIT (P/N: 0024-8555)



Check appliance CO levels using the optional appliance kit.



The analyzer detects and displays the presence of CO by first drawing in a gas sample from the area being tested by the analyzer's built-in motorized pump. The gas sample is next directed into a sensor chamber where the sample is analyzed for the presence of CO. If CO is detected, the CO ppm level is given on the analyzer's main display. A trending screen (accessible from the RUN screen by using the right or left arrow key) shows dynamic CO levels graphed

over a programmable time period (from 30 seconds to 15 minutes). In addition to the visual notifications, you can set a CO alarm limit, above which an audible alarm buzzer will beep repeatedly. An audible alarm with a slower beep frequency occurs when the batteries are low.

A backlight enables the operator to read the display in dimly-lit areas. The displays and menus are available in multiple languages (English, French and Spanish).

A permanent record of the detected CO level, along with the current time and date, can be made by using the optional wireless IrDA printer. Test records can also be saved in memory.

An ambient CO feature takes approximately 15 minutes to complete and provides a minute-by-minute snapshot of CO readings, as well as a “Max CO” value that represents the highest CO reading measured during the entire test. Results can be saved to memory and/or printed. Use the optional CO Appliance Kit (P/N 0024-8555) to perform an ambient CO measurement if required.

A calibration reminder can be set to occur every 6, 8, 10, 12, or 15 months after the last calibration. (Select “Never” to disable this feature.) Regular calibration periods of 6 months to 1 year are recommended. The calibration reminder value sets a time period after which the analyzer displays a calibration reminder message during warm-up.

To avoid the need for manual CO sensor calibrations, the B-Smart® Sensor program is supported with the Monoxor® Plus. After enrolling in the program, pre-calibrated replacement B-Smart® CO sensors are shipped at pre-determined intervals of your choice.

- Choose a program start date that best suites your needs.
- Receive a pre-calibrated B-Smart® sensor.
- Return your old sensor in a returnable, pre-labeled container.

Benefits include no downtime, self calibration, convenience, and cost savings. For additional information about the B-Smart® Calibration Program, contact Bacharach at 1-800-736-4666 or email Help@MyBacharach.com.

A programmable inactivity timeout causes the analyzer to initiate shutdown mode if no key presses occur for the specified time period. If the analyzer initiates automatic shutdown or is turned OFF manually while a high level of CO is still present within the unit, the automatic CO purge feature forces the analyzer’s pump to remain on until the detected CO level drops below 50 ppm.

The instrument is supplied with the following components:

- probe and hose assembly
- four disposable “AA” alkaline batteries
- hard carrying case
- factory-calibrated and installed CO sensor.

Depending on the model and kit, some or all of the following components are included:

- spare filters
- Fyrite® User Software (FUS)
- USB cable (type A to mini B)
- Infrared Data Association (IrDA) printer with four disposable “AA” alkaline batteries
- printer paper.

Using the optional thermocouples, ambient and flue gas temperatures can be measured. Additionally, the Monoxor® Plus can calculate a differential temperature based on two sampled temperatures (T1 and T2) using the optional stack thermocouple or optional probe assembly (with built-in thermocouple). After you take the two sample readings, the differential value (T1-T2) is calculated, optionally saved in memory, displayed on the main run screen, and is shown on printouts.



1.5. Components

- | | |
|---|--|
| <ol style="list-style-type: none"> 1 Monochrome Display (LCD) with Backlight 2 Function Keys (F1, F2, and F3) <ul style="list-style-type: none"> • Context sensitive • Functions shown at bottom of display 3, 4 Up and Down Arrow Keys <ul style="list-style-type: none"> • Scroll up/down through a list • Increase/decrease alphanumeric values 5, 6 Left and Right Arrow Keys <ul style="list-style-type: none"> • Scroll left/right through a field • Jump to top/bottom of list • Access the trending screen 7 Enter Key <ul style="list-style-type: none"> • Choose highlighted item • Accept value/characters 8 Escape Key <ul style="list-style-type: none"> • Cancel most operations and display previous screen 9 Power/Backlight Key <ul style="list-style-type: none"> • Press & release Power ON • Press & release Toggle backlight ON/OFF • Press & hold (2 secs) Begin power OFF sequence 10 Run/Hold Key <ul style="list-style-type: none"> • While in HOLD Turn on pump, display RUN screen, and begin test. • While in RUN Turn off pump, display HOLD screen and last set of test data. • In most menus Display HOLD screen. • During power down Return display to HOLD screen (cancel power down). | |
|---|--|

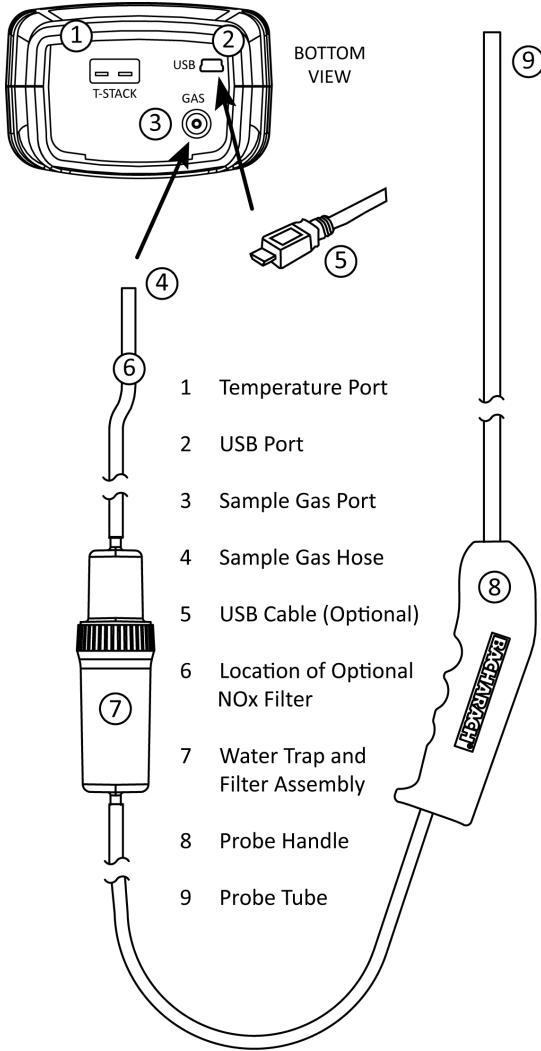

1.6. Features

- Sensors (pp 9, 17, 18, 32, 42)
 - Field-replaceable electrochemical sensor (B-Smart[®] CO)
 - Temperature measurement using a Type K thermocouple (with probe assembly 19-7111)
- Power (pp 10, 13)
 - 4 AA alkaline batteries (included)
 - 4 AA lithium batteries
 - 4 AA rechargeable batteries (externally charged)
 - Low battery warning
- Testing Features (pp 17, 19, 28, 29, 30, 31)
 - Complete test results (10 sets) can be stored, recalled, displayed, and printed
 - Time and date stamping of test results
 - Differential temperature
 - Secure calibration function (password protected)
 - Auto power-off feature with sensor purge feature
 - Status and diagnostic menus
 - Ambient CO
- User Customizations (p 20)
 - Multi-language interface
 - Auto/Manual zero functions for the CO sensor
 - Customized user information (3 lines of 20 characters)
 - Customized logo on printouts (192 x 384 pixels)
 - Temperature unit selection
- Hardware (pp 6, 11, 32, 38)
 - Probe/hose assembly for gas transport
 - Sample pump to provide gas sample delivery
 - Backlit monochrome graphic LCD
 - Hard carrying case
 - USB 2.0 (mini-B connection) for PC interface and communications
- PC Interface (p 38)
 - USB cable (Type A to Mini B)
 - Fyrite[®] User Software (FUS) (Windows compatible)
 - Updates

1.7. Monoxor® Plus Sales Combinations

Components	Basic Kit 0019-8117	Reporting Kit 0019-8118
Probe	X	X
Batteries	X	X
Temperature	X	X
Manual	X	X
B-Smart® CO Sensor	X	X
Hard Case	X	X
Printer		X
PC Software		X
USB Cable		X

1.8. Specifications

Measure-ment	Range	Resolution	Accuracy	Response Time (T90)
CO	0 to 2000 ppm	1 ppm	±10 ppm (0 to 200) ±5% reading (201 to 2000)	< 40 sec
Temp	-20° to 650° C (-4° to 1202° F)	1° C (1° F)	±2° C (0° to 124° C) ±3° C (125° to 249° C) ±4° C (250° to 400° C)	< 50 sec

Specification	Description		
Temperature	Storage:	-20° to 50° C (-4° to 122° F) 0° to 20° C (32° to 68° F) optimal	
	Operation:	-5° to 45° C (23° to 113° F)	
	Reference:	20° ± 2° C (68° ± 4° F)	
Humidity	Storage:	15 to 90% RH, non-condensing	
	Operation:	15 to 95% RH, non-condensing	
	Reference:	45 ± 10% RH, non-condensing	
Pressure	1 atmosphere ± 10%		
Weight	16 ounces (454 g) with batteries		
Dimensions	8.0" x 3.6" x 2.3" (20.3 cm x 9.1 cm x 5.8 cm) (H x W x D)		
Warm-up Time	Minimum = 30 seconds; Maximum = 60 seconds		
Gas Sample Flow Rate	300 to 700 cc/min		
Sensors	CO:	Electrochemical (P/N: 0024-7265)	
	Temp:	K-Type thermocouple	
Product Approvals and Regulatory Compliance	EN50270:	(CE Mark) EMC tested in accordance with European Directive 2004/108/EC .	
	RoHS Compliance		
Case Construction	High impact ABS plastic with co-molded rubber. Optional protective rubber boot with molded-in magnets.		
Display	Monochrome with backlight		
USB Connector	Mini B (USB 2.0)		
Memory	10 locations for storing test results		
IrDA Port	Protocol:	IrDA-SIR	Data Bits: 8 Stop Bits: 1
	Baud Rate:	9600	Parity: None
Power Supply Options	Batteries (4 AA)	Type:	Disposable Alkaline (Included)
		Duration:	15 hours min, continuous max draw
		Type:	Disposable Lithium
	Duration:	20 hours, continuous max draw	
	Type:	Rechargeable	
	Duration:	8 hours, continuous max draw	



Section 2. Setup





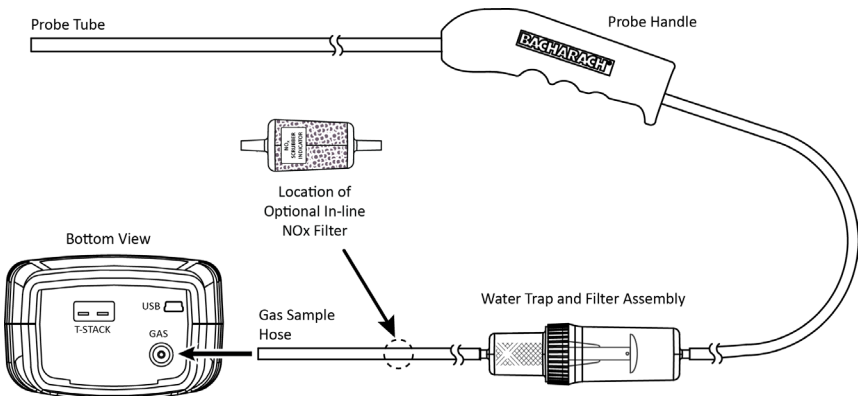

2.1. Connecting the Probe

A rigid stainless steel probe with handle is connected to a flexible hose with an integral water trap/filter and is used to draw a gas sample into the analyzer from the room, grilles, diffusers, and furnace flues.

1. Inspect the flexible hose for cracks. If a hose is defective, replace the entire probe assembly.
2. Before using the analyzer, check that the water trap/filter is clean and dry. If necessary, dry out the trap and replace the filter element.
3. Push the probe's "sample gas" tubing onto the GAS inlet connector.



2.2. Front Panel Buttons

Button	Description
	<ul style="list-style-type: none"> • Powers the analyzer ON and OFF. Hold this button down for at least 2 seconds to turn the power OFF. • Toggles the backlight ON and OFF while the analyzer is turned ON.
	<ul style="list-style-type: none"> • UP (▲), DOWN (▼), LEFT (◀), and RIGHT (▶) arrows are context-specific navigation buttons for the menus. • UP (▲) and DOWN (▼) arrow buttons scroll to menu options that are hidden from view (when a side scroll bar is displayed indicating additional information). • UP (▲) and DOWN (▼) arrow buttons cause the displayed value to increase or decrease accordingly. • LEFT (◀) and RIGHT (▶) arrow buttons jump to the top and bottom of lists, respectively. • LEFT (◀) and RIGHT (▶) arrow buttons position the active cursor on specific elements of a value to be changed. • LEFT (◀) and RIGHT (▶) arrow buttons display the CO Trending screen from the Run/Hold screen.
	<ul style="list-style-type: none"> • The ENTER button. Performs the action selected.
	<ul style="list-style-type: none"> • While in the HOLD screen, turns the sample pump on, displays the RUN screen, and begins a test. • While in the RUN screen, turns the sample pump off, displays the HOLD screen and the last set of data. • Displays the HOLD screen while pressing it from most menus. • Returns the display to the HOLD screen while pressing it during the shutdown sequence.
	<ul style="list-style-type: none"> • The ESC button cancels most operations and displays the previous screen.
	<ul style="list-style-type: none"> • Pressing function keys accepts the corresponding function defined above that key at the bottom of the display (for example, PRINT, SAVE, MENU, etc.).

2.3. Power Options

Power options include:

- Disposable AA alkaline batteries (included)
- Disposable AA lithium (Li) batteries
- Externally charged rechargeable NiMH batteries.

Check the Monoxor[®] Plus for sufficient power prior to each use. Replace the batteries if the low (or replace) battery symbol appears in the upper right corner of the Monoxor[®] Plus screen.

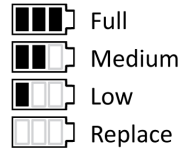

Batteries (4 AA, Fresh or Fully Charged)	Estimated Life Span in Hours (Continuous, Pump On)
Alkaline (disposable)	15 hours
Lithium (disposable)	20 hours
Rechargeable	8 hours

Replace batteries as follows.

1. Remove the battery cover from the back of analyzer.
2. If old batteries are installed, remove them and properly discard them.
3. Observing the polarity markings inside the battery compartment, install four 'AA' disposable (alkaline or lithium) batteries or four fully-charged (externally charged) AA rechargeable NiMH batteries.
4. Replace the battery cover.



NOTE: The Monoxor[®] Plus does NOT charge rechargeable batteries.



NOTE: The Monoxor[®] Plus sounds a series of beeps to indicate that the batteries need to be replaced.

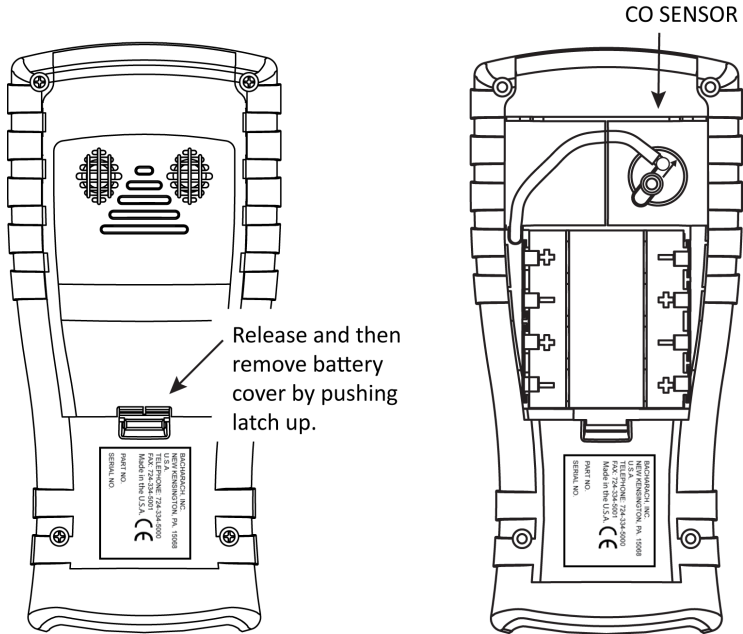

NOTE: A Set Clock error message will be displayed if the instrument is without power for an extended period of time.

2.4. Turning On the Monoxor[®] Plus

To turn on the Monoxor[®] Plus, press the PWR button.



NOTE: After turning on the Monoxor[®] Plus, it performs a warm-up procedure which includes an auto-zero procedure (when in Auto Zero mode) for the sensors (see pages 15 and 26). For this reason, be sure to turn on the Monoxor[®] Plus in a clean air environment. When the analyzer is in CO Manual mode, the analyzer will indicate the background CO during startup.





Section 3. Configuration

3.1. Menu Structure Overview



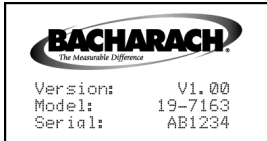
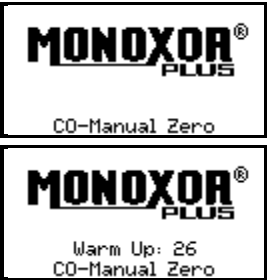



Menus and the items contained within them are described in a top-down fashion, starting from the startup screens and working sequentially through the menus and menu items.

3.2. The Warm-up Sequence



Boot Screens	Description
	<p>Splash screen shows the Bacharach logo with version, model number, and serial number information. This screen is displayed for approximately 3 seconds.</p>
	<p>A warm-up screen is displayed during which the instrument is purged and initialized. The current zero setting for the CO sensor (Auto-Zero or Manual Zero) is displayed briefly, followed by a countdown timer during initialization (see page 26 and page 46).</p>
	<p>If any errors are detected during warm-up, the corresponding error messages are displayed, after which the user presses F2 to go to the Menu, or presses RUN/HOLD to go to the Hold screen. (See page 49 for a list of error messages.)</p>

3.3. Main Menu

Display the Main Menu by pressing the F2 key. Note that features and items displayed in menus are model dependent. Your screens may vary.

Main Menu	Function
 <p>Main Menu Ambient CO Test Diff Temp Memory Setup Menu</p>	<p>Access the Ambient CO Test Menu (see page 17)</p> <ul style="list-style-type: none"> • Initiate a 15-minute CO test • Get reading every minute and max CO reading • Print/Save 16 readings and max CO
 <p>Main Menu Ambient CO Test Diff Temp Memory Setup Menu</p>	<p>Access the Differential Temperature Menu (see page 18)</p> <ul style="list-style-type: none"> • Display current temperature reading. • Display differential temperature readings • Save differential temperature information
 <p>Main Menu Ambient CO Test Diff Temp Memory Setup Menu</p>	<p>Access the Memory Options Menu (see page 19).</p> <ul style="list-style-type: none"> • Access previously saved test results • Delete all previously saved test results
 <p>Main Menu Ambient CO Test Diff Temp Memory Setup Menu</p>	<p>Access the Setup Menu (see page 20).</p> <ul style="list-style-type: none"> • Edit/view instrument preference • Edit/view system parameters • Edit/view test parameters
 <p>Main Menu Setup Calibration Diagnostics Status Menu</p>	<p>Access the Calibration Password Screen and the Calibration Menu (see page 28).</p> <ul style="list-style-type: none"> • Calibrate sensors
 <p>Main Menu Setup Calibration Diagnostics Status Menu</p>	<p>Access the Diagnostics Menu (see page 29).</p> <ul style="list-style-type: none"> • View “run” meters and system diagnostic values • Fresh air diagnostics
 <p>Main Menu Setup Calibration Diagnostics Status Menu</p>	<p>Access the Device Status Menu (see page 30).</p> <ul style="list-style-type: none"> • Access the software date, model number, serial number, and version information

3.4. Ambient CO Menu

Ambient CO	Function										
	<p>Access the Ambient CO Menu.</p> <p>When initiated, the Ambient CO feature monitors CO values continuously and captures a reading every minute for 15 minutes (a total of 16 readings from t_0 to t_{15}).</p> <p>Press ENTER to initiate the Ambient CO test. This begins a 15-minute test cycle, during which a status screen is displayed. It shows the starting ambient CO value, the current CO value, and the elapsed time into the test.</p> <div style="text-align: center; margin: 10px 0;">  </div> <table border="1" style="width: 100%; border-collapse: collapse; margin: 10px 0;"> <thead> <tr style="background-color: black; color: white;"> <th style="width: 50%;">Ambient CO</th> <th style="width: 50%;">Ambient CO</th> </tr> </thead> <tbody> <tr> <td style="font-family: monospace;">Start: 0 ppm</td> <td style="font-family: monospace;">Start: 0 ppm</td> </tr> <tr> <td style="font-family: monospace;">Current: 0 ppm</td> <td style="font-family: monospace;">Current: 0 ppm</td> </tr> <tr> <td style="font-family: monospace;">Time: 00:03</td> <td style="font-family: monospace;">Time: 13:40</td> </tr> <tr style="background-color: black; color: white;"> <td style="text-align: center;">Cancel</td> <td style="text-align: center;">Cancel</td> </tr> </tbody> </table>	Ambient CO	Ambient CO	Start: 0 ppm	Start: 0 ppm	Current: 0 ppm	Current: 0 ppm	Time: 00:03	Time: 13:40	Cancel	Cancel
Ambient CO	Ambient CO										
Start: 0 ppm	Start: 0 ppm										
Current: 0 ppm	Current: 0 ppm										
Time: 00:03	Time: 13:40										
Cancel	Cancel										
	<hr/> <div style="display: flex; align-items: center; margin-bottom: 10px;"> <p>NOTE: Press the F2 key to cancel a test in progress.</p> </div> <hr/> <p>After the test is complete, the Ambient CO Summary screen is displayed. This is a scrollable window that shows the 16 CO “snapshot” readings, as well as the maximum CO reading that was sampled during the entire test.</p> <hr/> <div style="display: flex; align-items: center; margin-bottom: 10px;"> <p>NOTE: The Max CO Reading is the highest sampled CO reading – even if the reading was taken in between one of the sample “snapshot” readings.</p> </div> <hr/>										

Ambient CO	Function																																				
	<table border="1" data-bbox="416 203 944 337"> <thead> <tr> <th colspan="2">Ambient CO Summary</th> <th colspan="2">Ambient CO Summary</th> </tr> <tr> <th>Time(min)</th> <th>CO(ppm)</th> <th></th> <th></th> </tr> </thead> <tbody> <tr> <td>0</td> <td>0</td> <td>13</td> <td>0</td> </tr> <tr> <td>1</td> <td>0</td> <td>14</td> <td>0</td> </tr> <tr> <td>2</td> <td>0</td> <td>15</td> <td>0</td> </tr> <tr> <td></td> <td></td> <td>Max CO</td> <td>0</td> </tr> <tr> <td>Print</td> <td>Menu</td> <td>Save</td> <td>Print</td> </tr> <tr> <td></td> <td></td> <td></td> <td>Menu</td> </tr> <tr> <td></td> <td></td> <td></td> <td>Save</td> </tr> </tbody> </table> <p data-bbox="408 345 953 428">The test results can be printed by pressing F1 and saved to memory (with a time and date stamp) by pressing F3. Press F2 to return to the menu.</p> <hr/> <div data-bbox="442 467 483 545">  </div> <p data-bbox="511 479 939 532">NOTE: Any over-range CO values (e.g., CO > 2000 ppm) are displayed as “xxx”.</p>	Ambient CO Summary		Ambient CO Summary		Time(min)	CO(ppm)			0	0	13	0	1	0	14	0	2	0	15	0			Max CO	0	Print	Menu	Save	Print				Menu				Save
Ambient CO Summary		Ambient CO Summary																																			
Time(min)	CO(ppm)																																				
0	0	13	0																																		
1	0	14	0																																		
2	0	15	0																																		
		Max CO	0																																		
Print	Menu	Save	Print																																		
			Menu																																		
			Save																																		



3.5. Differential Temperature Menu

Diff Temp	Function																																												
<table border="1" data-bbox="110 701 373 833"> <thead> <tr> <th colspan="2">Main Menu</th> </tr> </thead> <tbody> <tr> <td>Ambient CO Test</td> <td></td> </tr> <tr> <td>Diff Temp</td> <td></td> </tr> <tr> <td>Memory</td> <td></td> </tr> <tr> <td>Setup</td> <td></td> </tr> <tr> <td colspan="2">Menu</td> </tr> </tbody> </table>	Main Menu		Ambient CO Test		Diff Temp		Memory		Setup		Menu		<p data-bbox="408 701 953 755">The Diff Temp option is used to calculate a differential temperature based on two sampled temperatures.</p> <p data-bbox="408 764 953 906">When this option is first selected, the current temperature (Temp) is displayed. Values for T1 and T2 will show no readings until they are saved by the operator, after which a differential value (T1-T2) will also be displayed.</p> <p data-bbox="408 915 953 1175">With temperature #1 (T1) selected, position the thermocouple in the target location, and wait for the temperature reading (Temp) to stabilize. Press the SAVE button to temporarily store the T1 value. Repeat these steps for the temperature #2 (T2). After saving both values, the “T1-T2” differential temperature will be displayed. At this point, you may press SAVE again to save the differential temperature value to memory so that it can be retrieved and/or printed later.</p> <table border="1" data-bbox="416 1187 944 1318"> <thead> <tr> <th colspan="2">Diff Temp</th> <th colspan="2">Diff Temp</th> </tr> </thead> <tbody> <tr> <td>Temp</td> <td>82 °F</td> <td>Temp</td> <td>82 °F</td> </tr> <tr> <td>T1</td> <td>--- °F</td> <td>T1</td> <td>84 °F</td> </tr> <tr> <td>T2</td> <td>--- °F</td> <td>T2</td> <td>82 °F</td> </tr> <tr> <td></td> <td></td> <td>T1-T2</td> <td>2 °F</td> </tr> <tr> <td>Clear</td> <td>Menu</td> <td>Save</td> <td>Clear</td> </tr> <tr> <td></td> <td></td> <td></td> <td>Menu</td> </tr> <tr> <td></td> <td></td> <td></td> <td>Save</td> </tr> </tbody> </table> <p data-bbox="408 1328 953 1382">Note that a negative differential value will be displayed if T1<T2.</p>	Diff Temp		Diff Temp		Temp	82 °F	Temp	82 °F	T1	--- °F	T1	84 °F	T2	--- °F	T2	82 °F			T1-T2	2 °F	Clear	Menu	Save	Clear				Menu				Save
Main Menu																																													
Ambient CO Test																																													
Diff Temp																																													
Memory																																													
Setup																																													
Menu																																													
Diff Temp		Diff Temp																																											
Temp	82 °F	Temp	82 °F																																										
T1	--- °F	T1	84 °F																																										
T2	--- °F	T2	82 °F																																										
		T1-T2	2 °F																																										
Clear	Menu	Save	Clear																																										
			Menu																																										
			Save																																										









NOTE: The Differential Temperature feature requires the use of the optional thermocouple (P/N: 0104-1797) or the optional probe assembly (P/N: 0019-7111).

3.6. Memory Options Menu







Memory Options	Function
	<p>Access the Memory Directory.</p> <p>This directory contains a numbered list of saved tests (starting at “1”) to a maximum of 10 test records. “NO DATA” is displayed if no tests were saved since the last time that memory was cleared. A “Memory Full” message is displayed if you try to save an 11th test.</p> <div style="display: flex; justify-content: space-around;"> <div style="border: 1px solid black; padding: 2px;"> <p style="text-align: center;">Memory Directory</p> <p>1 04/16/13 02:56:43</p> <p>2 04/16/13 02:56:46</p> <p>3 04/16/13 02:56:48</p> <p>4 04/16/13 02:56:51</p> <p style="text-align: center;">PAGE- Menu PAGE+</p> </div> <div style="border: 1px solid black; padding: 2px;"> <p style="text-align: center;">Memory Directory</p> <p>No Data</p> <p style="text-align: center;">PAGE- Menu PAGE+</p> </div> </div> <p>To view saved data, use the UP (▲) and DOWN (▼) arrow buttons to highlight the desired test from the list. Press the ENTER button to display the saved data.</p> <div style="display: flex; justify-content: space-around;"> <div style="border: 1px solid black; padding: 2px;"> <p style="text-align: center;">Memory Directory</p> <p>1 02/24/08 02:01:43</p> <p>2 02/24/08 02:01:49</p> <p>3 02/24/08 02:01:54</p> <p>4 02/24/08 02:01:57</p> <p style="text-align: center;">PAGE- Menu PAGE+</p> </div> <div style="border: 1px solid black; padding: 2px;"> <p style="text-align: center;">Mem: 3</p> <p>CO 0 ppm</p> <p>Max 0 ppm</p> <p>Min 0 ppm</p> <p>Temp 82 °F</p> <p style="text-align: center;">Print Menu</p> </div> </div>
	<p>Prompts user before clearing all saved tests from memory. Selecting NO returns the display to the Memory Options menu.</p> <div style="display: flex; justify-content: space-around;"> <div style="border: 1px solid black; padding: 2px;"> <p style="text-align: center;">Clear Memory</p> <p>No</p> <p>Yes</p> <p style="text-align: center;">Menu</p> </div> <div style="border: 1px solid black; padding: 2px;"> <p style="text-align: center;">Memory Options</p> <p>Memory Directory</p> <p>Clear Memory</p> <p style="text-align: center;">Menu</p> </div> </div> <p>Selecting YES clears the memory and displays the Memory Cleared message.</p> <div style="display: flex; justify-content: space-around;"> <div style="border: 1px solid black; padding: 2px;"> <p style="text-align: center;">Clear Memory</p> <p>No</p> <p>Yes</p> <p style="text-align: center;">Menu</p> </div> <div style="border: 1px solid black; padding: 2px;"> <p style="text-align: center;">Clearing Memory</p> <p style="text-align: center;">Memory Cleared</p> <p style="text-align: center;">Menu</p> </div> </div>

3.7. Setup Menu



Setup Menu	Function
 <pre> Setup Menu Temperature Units Clock Zoom Username Menu </pre>	<p>Access Temperature Units (°C or °F) to be used by the instrument and for display and printing purposes.</p> <p>Use the UP (▲) and DOWN (▼) arrows buttons to highlight the desired choice.</p> <p>Press the ENTER button to use the selected temperature unit. Press ESC to quit without saving.</p> <div style="display: flex; justify-content: space-around;"> <div data-bbox="410 456 669 586">  <pre> Temp Units Menu Celsius Fahrenheit 06/28/13 09:01:32 AM Menu </pre> </div> <div data-bbox="685 456 948 586">  <pre> Temp Units Menu Celsius Fahrenheit 06/28/13 09:01:43 AM Menu </pre> </div> </div>
 <pre> Setup Menu Temperature Units Clock Zoom Username Menu </pre>	<p>The Clock option provides access to the clock setup function to set date and time.</p> <p>Use the LEFT (◀) and RIGHT (▶) arrow buttons to select the desired field to edit. Then use the UP (▲) and DOWN (▼) arrow buttons to change the values of the selected field.</p> <p>Press ENTER to save new date and time. Press ESC to quit without saving.</p> <hr/> <div style="display: flex; align-items: center;">  <p>NOTE: See DATE FORMAT option in SETUP MENU to select either MM/DD/YY format or DD/MM/YY format.</p> </div> <hr/> <div style="text-align: center;">  <pre> Set Clock 06/28/13 09:02 AM Press ENTER to Save 06/28/13 09:02:55 AM Menu </pre> </div> <hr/> <div style="display: flex; align-items: center;">  <p>NOTE: The presence of AM or PM after the time on the Set Clock display indicates 12-hour time format and MM/DD/YY date format.</p> <p>Similarly, the absence of AM or PM indicates 24-hour time format and the date is in DD/MM/YY format.</p> </div>





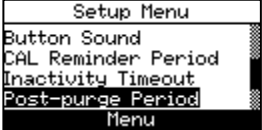

Setup Menu	Function
<pre> Setup Menu Temperature Units Clock Zoom Username Menu </pre>	<p>The zoom options selects the size of the characters on the Run/Hold screen. Three options are Standard, 2x, and 3x. Options are shown below with their respective Run/Hold screens. Use the UP (▲) and DOWN (▼) arrow buttons to scroll through display items that don't fit on the screen.</p>
<p style="text-align: center;">Zoom Level</p> <pre> Zoom Menu Standard 2x 3x 06/28/13 09:04:53 AM Menu </pre>	<p style="text-align: center;">Sample Run/Hold Screen</p> <pre> Hold CO 0 ppm Max 0 ppm Min 0 ppm Temp 88 °F Print Menu Save </pre>
<pre> Zoom Menu Standard 2x 3x 06/28/13 09:05:14 AM Menu </pre>	<pre> Hold CO 0 ppm Max 0 ppm Min 0 ppm Print Menu Save </pre>
<pre> Zoom Menu Standard 2x 3x 06/28/13 09:05:22 AM Menu </pre>	<pre> Hold CO 0 Max 0 Print Menu Save </pre>

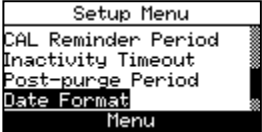
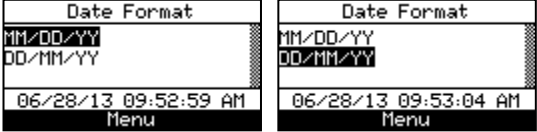

Setup Menu	Function
<pre> Setup Menu ----- Temperature Units Clock Zoom Username ----- Menu </pre>	<p>Provides an interface for entering user identification information used on printouts. Generally, the Username fields contain the HVAC company and related information.</p>
	<p>NOTE: This data can be entered using the Fyrite® User Software (FUS).</p>
	<p>Use the UP (▲) and DOWN (▼) arrow buttons to choose a row and press ENTER to begin editing the selected row. Then use the UP (▲) and DOWN (▼) arrow buttons to select the desired letter, number, or special character for the current text position.</p>
	<p>/ ! @ # \$ % & * - ' <SPACE> a-z A-Z 0-9</p>
	<p>Use the LEFT (◀) and RIGHT (▶) arrow buttons to move the cursor horizontally on the selected row and repeat the character selection process for each text position. When finished, press ENTER to save the row's changes. Repeat for all 3 lines. Then select EDIT COMPLETE and press ENTER to finish.</p>
	<p>SELECT MODE EDITING MODE</p>
<pre> Edit Username ----- Edit Complete ----- Menu CLEAR </pre>	<pre> Edit Username ----- ABC Heating & A/C ----- Edit Complete ----- Menu </pre>
<pre> Edit Username ----- Edit Complete ----- Menu CLEAR </pre>	<pre> Edit Username ----- ABC Heating & A/C 123 Plenum Parkway ----- Edit Complete ----- Menu </pre>
<pre> Edit Username ----- Edit Complete ----- Menu CLEAR </pre>	<pre> Edit Username ----- ABC Heating & A/C 123 Plenum Parkway Checking CO 12345 ----- Edit Complete ----- Menu </pre>
<pre> Edit Username ----- Edit Complete ----- Menu CLEAR </pre>	<pre> Edit Username ----- ABC Heating & A/C 123 Plenum Parkway Checking CO 12345 ----- Edit Complete ----- Menu CLEAR </pre>

Setup Menu	Function
	<p>The Language Selection option allows the user to choose a language for all menus. Use the UP (▲) and DOWN (▼) arrow buttons to scroll through language options. Use ENTER to enable the selected language.</p>  <p>Three languages are available: English, French, and Spanish.</p>
	<p>The button sound option is used to select whether or not the analyzer makes an audible sound every time a key is pressed. Select OFF to disable this feedback, or ON to enable this feedback. Then press ENTER to select, or ESC to discard changes.</p>  
	<p>The CAL Reminder Period option sets a time period after which the analyzer displays a calibration reminder message during warm-up. Calibration reminders can be set to occur never, 6, 8, 10, 12, or 15 months after the last calibration. Select NEVER (the default setting) to disable this feature. When the preset period is exceeded the instrument will display the reminder, and how long since the sensor was last calibrated. If a calibration reminder is displayed, the operator can press the RUN/HOLD key to move to the RUN/HOLD Screen for normal operation. Regular calibration periods of 6 months to 1 year are recommended.</p> <p>Set the calibration reminder period as follows:</p> <ol style="list-style-type: none"> 1. Use the UP (▲) and DOWN (▼) arrow buttons to select the desired time period. 2. Press ENTER to save the selection or ESC to revert to the previous setting.



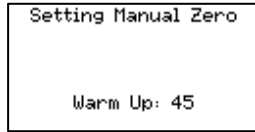

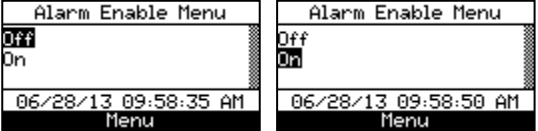
Setup Menu	Function
	<div data-bbox="444 250 487 328" style="display: inline-block; vertical-align: middle;"> </div> <p>NOTE: The date and time settings must be correct to get accurate calibration reminders.</p> <div style="display: flex; flex-wrap: wrap; justify-content: space-around;"> <div data-bbox="407 371 668 505" style="border: 1px solid black; padding: 2px;"> <p>CAL Reminder Period</p> <p>Never</p> <p>5 months</p> <p>8 months</p> <p>10 months</p> <p style="text-align: center;">Menu</p> </div> <div data-bbox="684 371 944 505" style="border: 1px solid black; padding: 2px;"> <p>CAL Reminder Period</p> <p>Never</p> <p>5 months</p> <p>8 months</p> <p>10 months</p> <p style="text-align: center;">Menu</p> </div> <div data-bbox="407 513 668 646" style="border: 1px solid black; padding: 2px;"> <p>CAL Reminder Period</p> <p>Never</p> <p>5 months</p> <p>8 months</p> <p>10 months</p> <p style="text-align: center;">Menu</p> </div> <div data-bbox="684 513 944 646" style="border: 1px solid black; padding: 2px;"> <p>CAL Reminder Period</p> <p>Never</p> <p>5 months</p> <p>8 months</p> <p>10 months</p> <p style="text-align: center;">Menu</p> </div> <div data-bbox="407 654 668 787" style="border: 1px solid black; padding: 2px;"> <p>CAL Reminder Period</p> <p>5 months</p> <p>8 months</p> <p>10 months</p> <p>12 months</p> <p style="text-align: center;">Menu</p> </div> <div data-bbox="684 654 944 787" style="border: 1px solid black; padding: 2px;"> <p>CAL Reminder Period</p> <p>8 months</p> <p>10 months</p> <p>12 months</p> <p>15 months</p> <p style="text-align: center;">Menu</p> </div> </div>
<div data-bbox="110 818 373 951" style="border: 1px solid black; padding: 2px;"> <p>Setup Menu</p> <p>Language Selection</p> <p>Button Sound</p> <p>CAL Reminder Period</p> <p>Inactivity Timeout</p> <p style="text-align: center;">Menu</p> </div>	<p>Provides a list from which to select an inactivity (key press) timeout for automatic shutdown. If no key presses occur for the time specified, the Monoxor® Plus initiates an automatic shutdown.</p> <p>Use the UP (▲) and DOWN (▼) arrow buttons to scroll through Inactivity Timeout options (None [default], 20, 30, or 60 minutes). Use the ENTER key to enable the selected timeout.</p> <div data-bbox="546 1065 809 1198" style="border: 1px solid black; padding: 2px; margin: 10px auto; width: fit-content;"> <p>Inactivity Timeout</p> <p>None</p> <p>20 minutes</p> <p>30 minutes</p> <p>06/28/13 09:50:22 AM</p> <p style="text-align: center;">Menu</p> </div>

Setup Menu	Function
 <p>Setup Menu Button Sound CAL Reminder Period Inactivity Timeout Post-purge Period Menu</p>	<p>Provides a list from which the user may chose a <i>minimum</i> purge duration time (<i>minimum</i> length of time that the pump continues to run) after shutdown is initiated. Use a longer Post-Purge Period if the Monoxor[®] Plus has been exposed to high concentrations of CO gas. Use ENTER to enable the selected Post-Purge Period. "PURGING SENSORS" is displayed on the shutdown screen if a Post-Purge Period is enabled.</p> <p>Use the UP (▲) and DOWN (▼) arrow buttons to scroll through Post-purge Period options.</p>  <p>Post-purge Period None 1 minute 5 minutes 06/28/13 09:51:51 AM Menu</p>
 <p>Setup Menu CAL Reminder Period Inactivity Timeout Post-purge Period Date Format Menu</p>	<p>The Date Format option provides a list from which the user may select the desired date format used by the instrument.</p> <ul style="list-style-type: none"> • MM/DD/YY (w/ 12-hour time format) • DD/MM/YY (w/ 24-hour time format) <p>Use the UP (▲) and DOWN (▼) arrow buttons to highlight the desired date format. Press ENTER to save new date format. Press ESC to quit without saving.</p>  <p>Date Format MM/DD/YY DD/MM/YY 06/28/13 09:52:59 AM Menu</p> <p>Date Format MM/DD/YY DD/MM/YY 06/28/13 09:53:04 AM Menu</p>





Setup Menu	Function
	<p>Provides a list from which the user may select the desired method for zeroing the CO sensor.</p> <ul style="list-style-type: none"> • <i>Auto-Zero</i> happens automatically at warm-up. • <i>Manual zero</i> is used to initiate the zeroing process whenever desired. <p>Use the UP (▲) and DOWN (▼) arrow buttons to highlight the desired zeroing method.</p> <p>Press ENTER to save. Press ESC to quit without saving.</p>
	<p style="text-align: center;">CO AUTO ZERO CO MANUAL ZERO</p>
	
	
	
	<p>By default, the Monoxor[®] Plus automatically zeroes all sensors on ambient air when the instrument is turned on.</p> <p>The Monoxor[®] Plus can be set to perform and store a manual zero for the CO sensor. The instrument uses the stored value to indicate background CO values after warm-up instead of performing an auto-zero on the background gas.</p>

Setup Menu	Function
 <pre>Setup Menu Post-purge Period Date Format CO Zero Setting CO Alarm Limit Menu</pre>	<p>The CO Alarm Limit option is used to enable and disable the alarm limit feature.</p>  <pre>Alarm Enable Menu Alarm Enable Menu Off Off On On 06/28/13 09:58:35 AM 06/28/13 09:58:50 AM Menu Menu</pre> <p>If enabled (ON), an additional screen is displayed where you set the CO alarm setpoint. The alarm limit is selectable from 0 to 2000 ppm. Use the Up and Down arrow buttons to scroll to the desired alarm limit value then press ENTER.</p>  <pre>CO Alarm Limit CO Alarm Limit CO Alarm Limit: 0 CO Alarm Limit: 2000 Press ENTER Press ENTER Menu Reset Menu Reset</pre> <p>Note that scrolling wraps forward and backwards, so pressing the down arrow at 0 ppm wraps backwards to 2000. Similarly, pressing up arrow at 2000 ppm wraps forward to 0 ppm.</p> <p>When the CO Alarm Limit option is enabled, the built-in buzzer will sound if CO readings exceed the CO alarm limit that you defined.</p>

3.8. Calibration Menu

Calibration Menu	Function
 <p>The screenshot shows a terminal window titled "Calibration Password". The text "Enter Password" is displayed with a cursor at the end. Below the input area, the word "Menu" is visible.</p>	<p>Calibration is performed by applying known values and accessing the password-protected menu items. When the Calibration Menu is selected, the user must enter a 4-digit numeric security code in order to proceed to the calibration options. The default password is 1111.</p> <p>Use the UP (▲) and DOWN (▼) arrow buttons to scroll through numerals 0-9 until the desired numeral is reached. Press ENTER to advance to the next position of the password. Press ENTER after all four digits are set. Press ESC to return to the SETUP MENU.</p>  <p>The screenshot shows the "Calibration Password" screen with "1111" entered and a cursor at the end.</p> <hr/> <p> NOTE: The calibration password can be changed through the Fyrite® User Software (FUS).</p> <hr/>  <p>The screenshot shows the "Calibration Menu" with options: Temp, CO, T-Ref, B-Smart. The word "Menu" is at the bottom.</p> <p>Refer to Chapter 5 (page 39) for additional screens and calibration procedures.</p>

3.9. Diagnostics Menu

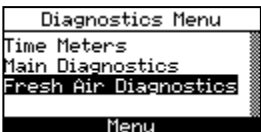
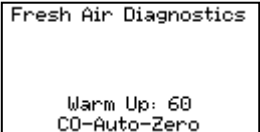
Diagnostics Menu	Function		
 <p>Diagnostics Menu Time Meters Main Diagnostics Fresh Air Diagnostics Menu</p>	<p>Displays time metrics for pump use and total operation time.</p>  <p>Time Meters Sample Pump Time: 4.1 hours Total Run Time: 7.7 hours Print Menu</p>		
 <p>Diagnostics Menu Time Meters Main Diagnostics Fresh Air Diagnostics Menu</p>	<p>Displays information about the measurement sensors of the instrument.</p>  <p>Main Diagnostics T-Stack Therm: ADC: 4568 Temp: 24°C Date: 01/06/12 Print Menu</p>		
 <p>Diagnostics Menu Time Meters Main Diagnostics Fresh Air Diagnostics Menu</p>	<p>Displays fresh air diagnostics similar to the display at warm-up. After the warm-up countdown, any detected errors are displayed. Otherwise, a "Success" message is displayed.</p>  <p>Fresh Air Diagnostics Warm Up: 60 CO-Auto-Zero</p> <table border="1" data-bbox="416 976 948 1110"> <tr> <td data-bbox="416 976 677 1110"> <p>Errors Detected Warmup Sensor Error CO Menu</p> </td> <td data-bbox="677 976 948 1110"> <p>No Errors Diag Successful Menu</p> </td> </tr> </table>	<p>Errors Detected Warmup Sensor Error CO Menu</p>	<p>No Errors Diag Successful Menu</p>
<p>Errors Detected Warmup Sensor Error CO Menu</p>	<p>No Errors Diag Successful Menu</p>		

3.10. Status Menu

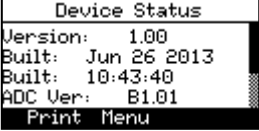
Status Menu	Function
 <pre> Main Menu Setup Calibration Diagnostics Status Menu </pre>	<p>This is the device status screen which displays information about the device. Some of the information displayed on this screen includes serial number, firmware version, model number, etc.</p>  <pre> Device Status Version: 1.00 Built: Jun 26 2013 Built: 10:43:40 ADC Ver: B1.01 Print Menu </pre>



Section 4. Operation

4.1. Overview

To operate the Monoxor[®] Plus, you simply . . .

- Turn the analyzer ON
- Wait for the unit to warm up
- Take a gas sample.

Before beginning your test, verify the following:

- menu items are properly configured
- the disposable filter is clean
- the probe is attached to the instrument
- the power is ON and sufficient (one of the following):
 - four new batteries (AA alkaline)
 - four new batteries (AA lithium)
 - four fully-charged AA rechargeable batteries
- the warm-up process has completed in fresh air without interruption or errors.

4.2. Taking a Gas Sample



IMPORTANT: Important! If the CO channel is set up for Auto Zero (refer to Section 3.4.3), ensure that the analyzer will be sampling fresh air (containing no CO) when turned ON.

Turn ON the analyzer by pressing the PWR button. Observe that when power is first applied, the software revision level is first displayed followed by a screen that counts down the warm-up period. The warm-up period is either 30 seconds or 60 seconds depending on the setting and sensor condition.

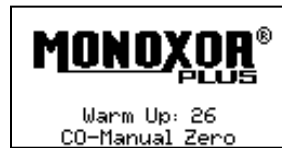
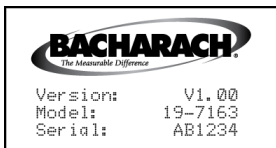

Following warm-up (and an optional error screen), the Main Menu screen appears. If the probe is being used, insert the probe tip into the area to be sampled. Press the Run/Hold button once to display the HOLD screen (last values), and a second time to display the RUN screen (dynamic display of current CO level in ppm, temperature, and min/max CO values).

Hold		Run	
CO	0 ppm	CO	0 ppm
Max	0 ppm	Max	0 ppm
Min	0 ppm	Min	0 ppm
Temp	87 °F	Temp	87 °F
Print Menu Save		Print Menu Save	



NOTE: If a sensor error was detected during warm-up, the CO Sensor Error Screen will be displayed.

4.3. The RUN and Hold Screens

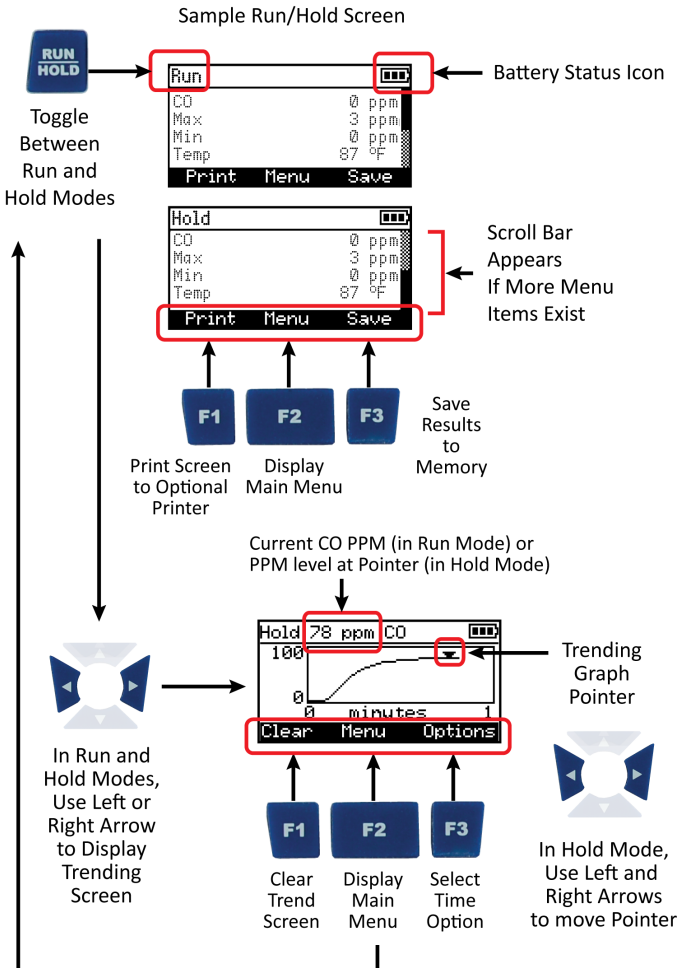



NOTE: Use the left or right arrow buttons from the Run or Hold screen to view the CO trending graph.

4.4. CO Trending Graph

A trending screen is accessible from the RUN or HOLD screen by using the right of left arrow keys. The CO Trending Screen shows dynamic CO levels graphed over a programmable time period. User-selectable time periods are:

- 30 seconds
- 1 minute
- 3 minutes
- 5 minutes
- 15 minutes.

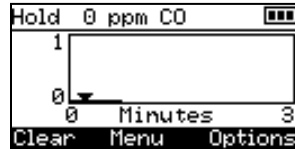
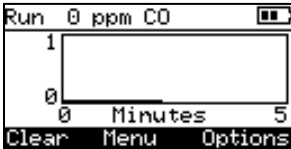

The graph continues to sample CO gas while in RUN mode, showing the current PPM reading above the dynamic graph. Press the RUN/HOLD button (HOLD mode) to freeze the current graphical snap-shot. In HOLD mode, a pointer appears on the graph. This pointer can be moved along the graph using the left and right arrow keys. As you move the pointer left and right, the value of the CO at that point in the sampling is displayed at the top of the screen.

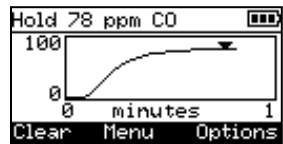
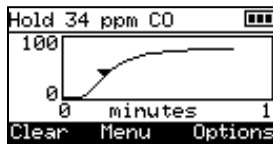
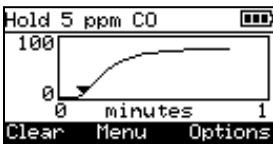

4.5. Ending a Test



WARNING: Burn Hazard. Do not touch the probe after removing it from a flue. Allow the probe to cool before handling (about 5 minutes).

After taking a gas sample, remove the probe and take the analyzer to an area containing fresh air. Allow the pump to run until the CO reading drops to near zero.

4.6. Taking Differential Temperature Measurements

In certain combustion applications, it may be desirable to have a differential temperature measurement. Use the Diff Temp menu and either the optional probe assembly with thermocouple (P/N 0019-7111), or one of the optional K-Type thermocouples (P/N 0104-1798 or P/N 0104-1797) to accomplish this task.

The Monoxor[®] Plus calculates the differential temperature based on two sampled temperatures (T1 and T2) which it reads from the optional probe assembly's thermocouple (which is connected to the T-STACK connector of the instrument). After you take the two sample readings, the differential value (T1-T2) is calculated, optionally saved in memory, displayed on the main run screen, and is shown on printouts. Use the following procedure to perform a differential temperature measurement.

Step	Example Procedure for Taking Differential Temperature Measurements
1	Attach the thermocouple plug of the optional probe assembly to the T-STACK connector on the bottom of the Monoxor [®] Plus.
2	From the Main Menu, select the Diff Temp option. When this option is first selected, the current temperature (Temp) is displayed. Values for T1 and T2 will show no readings until they are saved by the operator, after which a differential value (T1-T2) will also be displayed. <div style="display: flex; justify-content: space-around; margin-top: 10px;"> <div style="border: 1px solid black; padding: 5px; width: 45%;"> <p style="text-align: center; margin: 0;">Main Menu</p> <p>Ambient CO Test</p> <p>Diff Temp</p> <p>Memory</p> <p>Setup</p> <p style="text-align: center;">Menu</p> </div> <div style="border: 1px solid black; padding: 5px; width: 45%;"> <p style="text-align: center; margin: 0;">Diff Temp</p> <p>Temp 82 °F</p> <p>T1 --- °F</p> <p>T2 --- °F</p> <p style="text-align: center;">Clear Menu Save</p> </div> </div>
3	With T1 highlighted, position the probe at desired location #1.
4	After a T1 temperature reading is displayed and stabilizes, press the F3 (SAVE) button to store the current T1 temperature reading. The T2 temperature reading is highlighted.
5	Move the probe to desired location #2.
6	After a T2 temperature reading is displayed and stabilizes, press the F3 (SAVE) button to store the current T2 temperature reading.
7	The temperature differential temperature (T1-T2) will be displayed. <div style="display: flex; justify-content: space-around; margin-top: 10px;"> <div style="border: 1px solid black; padding: 5px; width: 45%;"> <p style="text-align: center; margin: 0;">Diff Temp</p> <p>Temp 82 °F</p> <p>T1 --- °F</p> <p>T2 --- °F</p> <p style="text-align: center;">Clear Menu Save</p> </div> <div style="border: 1px solid black; padding: 5px; width: 45%;"> <p style="text-align: center; margin: 0;">Diff Temp</p> <p>Temp 82 °F</p> <p>T1 84 °F</p> <p>T2 82 °F</p> <p>T1-T2 2 °F</p> <p style="text-align: center;">Clear Menu Save</p> </div> </div>

Step	Example Procedure for Taking Differential Temperature Measurements
8	At this point, you may press <i>SAVE</i> again to save the differential temperature value to memory so that it can be retrieved and/or printed later.
9	Carefully remove the probe assembly and allow it to cool.



NOTE: A negative differential value will be displayed if $T1 < T2$.

4.7. Timed Ambient CO Testing

This procedure takes approximately 15 minutes to complete and provides a minute-by-minute snapshot of CO readings, as well as a “Max CO” value that represents the highest CO reading measured during the entire 15-minute test. Results can be saved to memory and/or printed. Use the optional CO Appliance Kit (P/N 0024-8555) and the following procedure to perform an ambient CO measurement.

Step	Example Procedure for Taking Ambient CO Measurements
1	Attach optional appliance kit probe (P/N 0024-8555) if required.
2	Turn on the Monoxor [®] Plus in a fresh air environment and wait for initialization to complete.
3	Verify successful initialization (no errors).
4	Check battery status (see page 13). If battery life is questionable, replace the batteries, as the Ambient CO test takes approximately 15 minutes to complete.
5	Move instrument to target location to be tested.
6	Press F2 to display the Main Menu.
7	Use the down arrow to highlight Ambient CO Test and press the ENTER button.
8	Follow the on-screen instructions to initiate the test.
	Refer to page 17 for details on navigating the ambient CO test screens, viewing results, saving results to memory, and printing results.

4.8. Printing Using the Optional IrDA Printer

The instrument has the ability to store, recall (to the display), and print sets of time- and date-coded test records. The time and date are set through software menu selections.

- Displaying stored records is done through the MEMORY DIRECTORY MENU.
- Press F1 to print displayed test records.

Step	Example Printing Procedure Using Optional IrDA Printer
1	Monoxor [®] Plus should be turned on and displaying a screen with an F1 Print option.
2	Check for a sufficient supply of paper and batteries in the IrDA printer.
3	Turn on the printer.
4	Position the printer within 8 to 16 inches (20 to 41 cm) from the instrument and at no greater than a 60-degree angle.
5	Press F1 to print.
6	Turn off printer when complete.

```

Tri-State Inspection
123 Elm Steet
Kensington, PA 12345

BACHARACH

BACHARACH, Inc.
Monoxor Plus
SN: AB1234

=====

Time: 15:53:05
Date: 06/28/13

CO                0 ppm
Max                1 ppm
Min                0 ppm
Temp              79°F

-----

Comments:
    
```

```

Tri-State Inspection
123 Elm Steet
Kensington, PA 12345

BACHARACH

BACHARACH, Inc.
Monoxor Plus
SN: AB1234

=====

Time: 15:53:05
Date: 06/28/13

CO                0 ppm
Max                1 ppm
Min                0 ppm
Temp              79°F
T1-T2             54°F

-----

Comments:
    
```

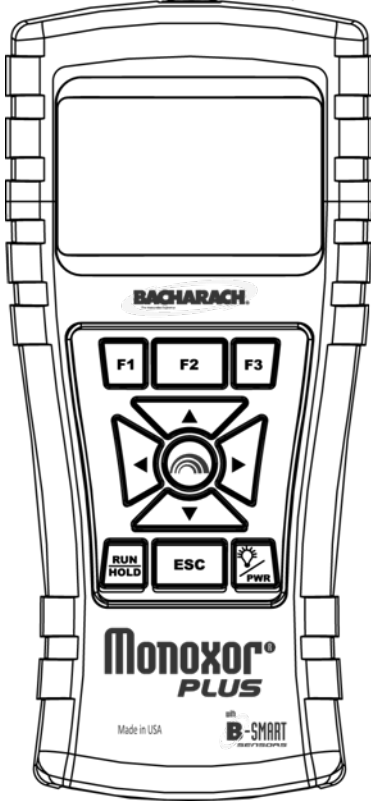
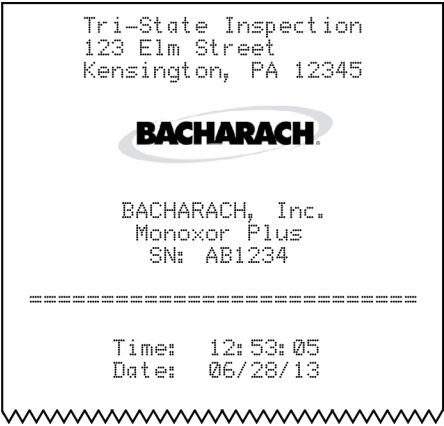

IR Communications Settings:

- Baud Rate: 9600
- Data Bits: 8
- Stop Bits: 1
- Parity: None
- Protocol: IRDA-SIR
- Distance: 8-16 in (20-41 cm)
- Angle: 60° maximum

The Monoxor® Plus provides three lines of 20 characters for user information. This information will appear with test records when they are printed. User name and optional information are entered via software menu selections in the SETUP MENU or via the Fyrite® User Software (FUS).

In addition to the three lines of text, the Monoxor® Plus can be setup to include a custom logo on printouts. Logos are loaded into the instrument using the Fyrite® User Software (FUS). Logo size is limited to 192 x 384 pixels (height x width) and must be in one of the following formats: .BMP, .JPG, .PNG, or .TIFF. For best results, the logo should be saved in black and white.

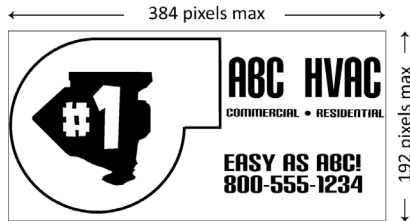

4.9. Turning Off the Analyzer

Turn OFF the analyzer by pressing the power button and holding for approximately 2 seconds. The analyzer will count down from 5seconds before turning OFF. Pressing ENTER, however, will abort the count down and keep the analyzer ON.



4.10. PC Interface and Fyrite® User Software

A PC with Fyrite® User Software (FUS) installed can set, edit, and transfer the following:

- instrument time and date
- calibration password
- time meters
- B-SMART® code
- user name
- instrument settings
- customer logo
- firmware updates
- language.



Section 5. Calibration and Maintenance

5.1. Serviceability

The instrument operator is able to easily replace the following components without the use of tools:

- probe assembly
- probe filters
- batteries
- B-Smart® CO sensor
- printer paper.

Additionally, a technician, with the use of factory-provided instructions, can:

- perform basic diagnostics
- confirm proper operation

before putting the unit back into service. Field calibration is also possible with the proper equipment. Refer to the calibration section for more information.

5.2. Cleaning the Probe

The probe tube and gas sample hose will become dirty under normal use.



NOTE: The filter element should prevent soot from reaching the analyzer's internal components. If the probe is not kept clean, it could become clogged and restrict the flow of gas into the analyzer, resulting in incorrect test readings.



NOTE: An analyzer that tests natural gas furnaces normally requires less frequent cleaning than an analyzer used for testing coal- or oil-fired furnaces.

5.2.1. Equipment Required

- Alcohol
- Aerosol Can of Automotive Carburetor Cleaner
- Clean Rag
- Source of Compressed Air (optional)



CAUTION: Do not use flammable or combustible substances (like carburetor fluid used for cleaning the probe) near an open flame.

5.2.2. Procedure

Step	Cleaning the Probe
1	Remove gas sample hose from the disposable filter assembly. <hr/>  CAUTION: Carburetor cleaner damages plastic components. Take precautions not to spray cleaner onto the probe handle or analyzer.
2	Insert the plastic spray tube of the carburetor cleaner into the gas sample hose, and then liberally spray carburetor cleaner through the hose and out the probe tube.
3	After spraying, remove all the residual cleaner by repeatedly flushing the gas hose and probe tube with alcohol.
4	Wipe off the surfaces of the probe and tubing with a clean cloth.
5	Allow the parts to dry completely. If available, blow compressed air through the probe to expedite the drying process.
6	Reconnect gas sample hose to the disposable filter assembly.

5.3. Filter Replacement

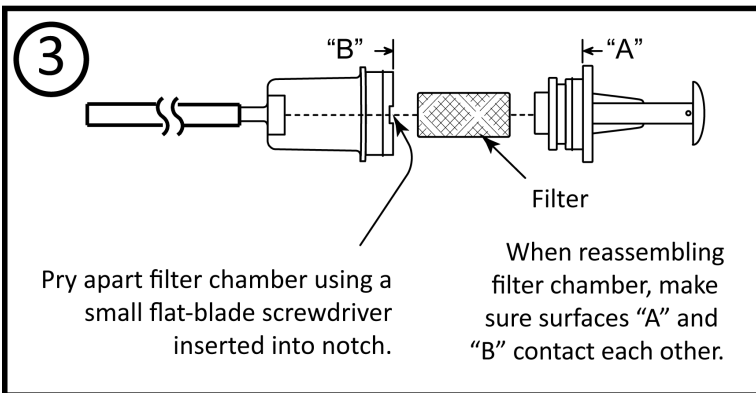
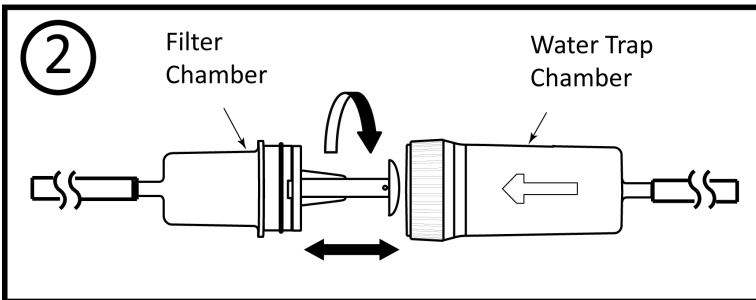
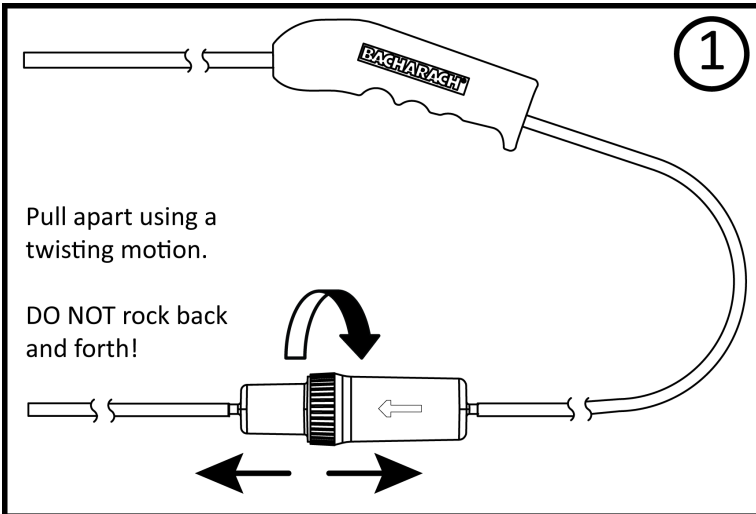

5.4. CO Sensor Replacement

5.4.1. Accessing the CO Sensor

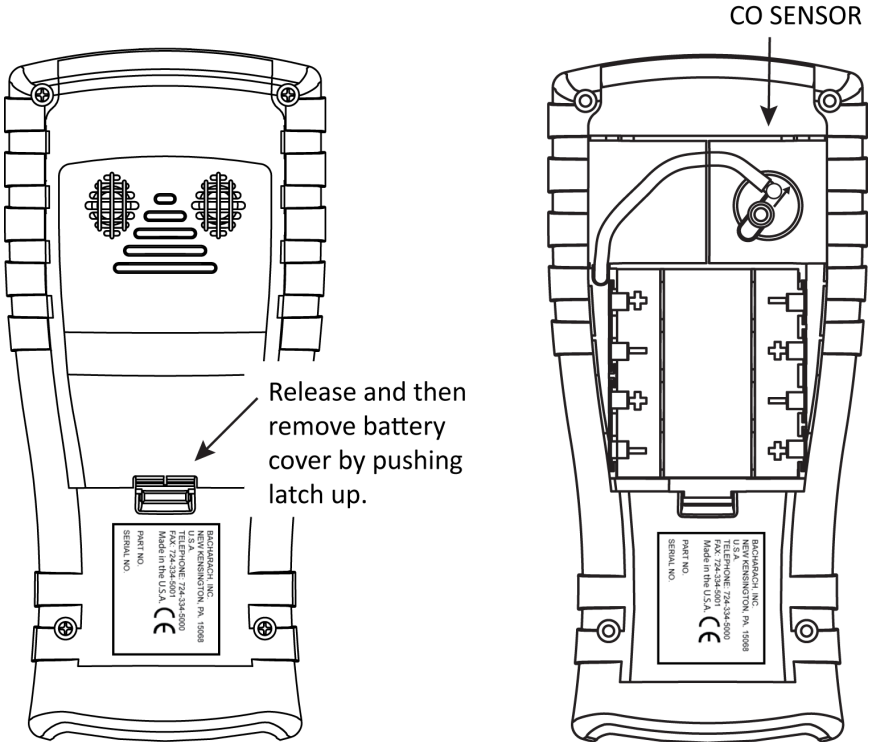

5.4.2. Material Required (As Needed)

- CO Sensor (P/N 0024-7265) or B-Smart® sensor (P/N 0024-1467).

5.4.3. CO Sensor Replacement Procedure

Follow the procedure below for CO sensor replacement.

Step	CO Sensor Replacement Procedure	
1	Remove battery door and the connector tubing from the CO sensor.	
2	Remove CO cap by twisting counter clockwise.	
3	Gently pull CO sensor out of its socket.	
4	Properly dispose of the old CO sensor.	
5	Plug new CO sensor into its socket.	
6	Install the CO cap by aligning it toward the "open" position (12 o'clock) as shown in the diagram below, then twisting the cap clockwise approximately 40° to the "closed" position (2 o'clock).	
7	Reattach tubing.	
8	Calibrate the CO sensor using either the standard calibration procedure or the B-SMART® procedure	

5.4.4. B-SMART® CO Sensor Replacement

Step	B-SMART® CO Sensor Replacement
1	Enter the CALIBRATION MENU. Note that this requires password validation (see page 28).
2	Use the UP (▲) and DOWN (▼) arrow buttons to select B-Smart. Press ENTER to display the B-Smart code screen.
3	Use the UP (▲) and DOWN (▼) arrow buttons to enter the 10-digit alphanumeric code supplied with the pre-calibrated B-SMART® sensor. Use the LEFT (◀) and RIGHT (▶) arrow buttons to move the cursor across the screen. Press ENTER.

Calibration Menu

Temp

CO

T-Ref

B-Smart

Menu



B-Smart

Enter Code

00-00-00-00-00

Press ENT

Menu

Step	B-SMART® CO Sensor Replacement
	<p> NOTE: If the correct code was entered, the analyzer accepts it and returns to the CALIBRATION MENU. If an incorrect code was entered, the screen will display "Invalid Code." Check to make sure the correct code has been entered. If problem persists, contact your nearest Bacharach Service Provider.</p> <hr/> <p> NOTE: B-SMART® codes can be entered through the Fyrite® User Software (FUS).</p>



NOTE: Installing a B-SMART® sensor forces the instrument to perform a zero function (either manual or automatic).



NOTE: Bacharach offers a convenient Exchange Program (where available) that allows the customer to regularly receive pre-calibrated replacement sensors that include a code that can be entered into the analyzer for a quick convenient setup. Contact Bacharach customer service for more details about this program.



5.5. Temperature Calibration



This procedure first zeroes and then spans the temperature channel to known temperature values.

The use of an electronic thermocouple simulator is the preferred method of producing the desired calibration temperatures. Alternatively, ice and boiling water baths can be used.

5.5.1. Materials Required

- Thermocouple simulator (K-type)
 - Range: 0 to 600° F (-18 to 316° F)
 - Accuracy: ± 0.5° F (± 0.3° C)
- (Alternatively) ice water, boiling water, thermometer

5.5.2. Temperature Calibration Procedure

Step	Temperature Calibration Procedure
1	<p>Plug the simulator into the TEMP connector located at the bottom of the analyzer.</p> <p>Alternatively: Plug the probe's thermocouple into the TEMP connector located at the bottom of the analyzer if using optional probe with thermocouple accessory (P/N 0024-7111).</p> <hr/> <div style="display: flex; align-items: center;">  <p>IMPORTANT: DO NOT attach the probe's gas hose to the analyzer's GAS port; otherwise water will be drawn into the analyzer!</p> </div> <hr/>
2	<p>If not already done, turn ON the analyzer and display the CALIBRATION Menu. Note that this requires password validation (see page 28).</p>
3	<p>Use the UP (▲) and DOWN (▼) arrow buttons to highlight Temperature, and then press ENTER to display the CALIBRATE TS-ZERO screen.</p> <div style="display: flex; justify-content: space-around; align-items: center;"> <div style="border: 1px solid black; padding: 5px; width: 150px;"> <p style="text-align: center; margin: 0;">Calibration Menu</p> <p>Temp</p> <p>CO</p> <p>T-Ref</p> <p>B-Smart</p> <p style="text-align: center; margin-top: 5px;">Menu</p> </div> <div style="border: 1px solid black; padding: 5px; width: 150px;"> <p style="text-align: center; margin: 0;">Calibrate TS-Zero</p> <p>Measured: 31 °F</p> <p>Applied: 32.0 °F</p> <p>Press ENT</p> <div style="display: flex; justify-content: space-between; margin-top: 5px;"> Print Reset </div> </div> </div> <p>"Measured" is the current temperature reading. "Applied" is a known temperature that will be applied for calibration purposes.</p>
4	<p>Set thermocouple simulator to 32° F (0° C), and then use the UP (▲), DOWN (▼), LEFT (◀), and RIGHT (▶) arrow buttons to enter an Applied value that exactly equals the setting of the simulator.</p> <p>Alternatively: Submerge probe tip into an ice-water bath with a thermometer, wait several minutes, and then use the UP (▲) and DOWN (▼) arrow buttons to enter an Applied value that exactly equals the thermometer reading.</p> <hr/> <div style="display: flex; align-items: center;">  <p>NOTE: The calibration range is from 32 to 41° F (0 to 5° C). An attempt to calibrate outside this range will cause the message "Applied Value High" (or Low) to appear at the bottom of the screen.</p> </div> <hr/>
5	<p>Wait until the Measured reading stabilizes, and then press ENTER to calibrate the TS-Zero Measured value to that of the Applied value, after which the message "Good Calibration" should briefly appear followed by the CALIBRATE TS-SPAN screen.</p>
6	<p>Set thermocouple simulator to 572° F (300° C), and then use the UP (▲), DOWN (▼), LEFT (◀), and RIGHT (▶) arrow buttons to enter an Applied</p>

Step	Temperature Calibration Procedure
	<p>value that exactly equals the setting of the simulator.</p> <div data-bbox="437 228 703 363" style="border: 1px solid black; padding: 5px; margin: 10px auto; width: fit-content;"> <pre> Calibrate TS-Span Measured: 570 °F Applied: 572 °F Press ENT Print Reset </pre> </div> <p>Alternatively: Submerge probe tip into a container of boiling water with a thermometer, wait several minutes, and then use the arrow buttons to enter an Applied value that exactly equals the thermometer reading.</p> <hr/> <p> NOTE: The calibration range is from 175 to 625° F (80 to 329° C). An attempt to calibrate outside this range will cause the message “Applied Value High” (or Low) to appear at the bottom of the screen.</p>
7	<p>Wait until the Measured reading stabilizes, and then press ENTER to calibrate the TS-Span Measured value to that of the “Applied” value, after which the message “Good Calibration” should briefly appear followed by the CALIBRATION menu being re-displayed.</p>

5.6. CO Sensor Calibration

5.6.1. Materials Required

- Calibration kit, P/N 0024-7059
- Gas cylinder: 500 ppm CO in air, P/N 0024-0492

5.6.2. CO Manual Zero Procedure

The CO zeroing process is done automatically during warm-up or manually using the manual zero feature (see page 26). To perform a manual zero, follow the steps below. If your instrument is configured for CO auto zero, then skip this CO manual zero procedure and go to the CO Sensor Span procedure that follows.

Step	Manual CO Zero Procedure
1	If not already done, turn ON the analyzer and display the Main Menu screen.
2	Use the UP (▲) and DOWN (▼) arrow buttons to select the SETUP menu and press ENTER.
3	From the Setup Menu, use the UP (▲) and DOWN (▼) arrow buttons to select the CO Zero Setting parameter then press ENTER.

Step	Manual CO Zero Procedure
	<div style="display: flex; justify-content: space-around;"> <div style="border: 1px solid black; padding: 5px; width: 45%;"> <p style="text-align: center;">Main Menu</p> <p>Diff Temp</p> <p>Memory</p> <p>Setup</p> <p>Calibration</p> <p style="text-align: center;">Menu</p> </div> <div style="border: 1px solid black; padding: 5px; width: 45%;"> <p style="text-align: center;">Setup Menu</p> <p>Post-purge Period</p> <p>Date Format</p> <p>CO Zero Setting</p> <p>CO Alarm Limit</p> <p style="text-align: center;">Menu</p> </div> </div>
4	<p>From the CO Zero Setting screen, use the DOWN (▼) arrow button to select the Manual Zero option then press ENTER. A reminder screen to place the instrument in fresh air is displayed.</p> <div style="display: flex; justify-content: space-around;"> <div style="border: 1px solid black; padding: 5px; width: 45%;"> <p style="text-align: center;">CO Zero Setting</p> <p>Auto-Zero</p> <p>Manual Zero</p> <p style="text-align: center;">Menu</p> </div> <div style="border: 1px solid black; padding: 5px; width: 45%;"> <p style="text-align: center;">Manual Zero</p> <p>Place instrument in fresh air to zero</p> <p style="text-align: center;">Press ENTER</p> <p style="text-align: center;">Menu</p> </div> </div>
5	<p>Press ENTER and wait for the manual zero to complete.</p> <div style="border: 1px solid black; padding: 10px; width: fit-content; margin: 10px auto;"> <p style="text-align: center;">Setting Manual Zero</p> <p style="text-align: center; margin-top: 20px;">Warm Up: 45</p> </div>

5.6.3. CO Sensor Span Procedure

Step	CO Span Procedure
1	<p>From the Calibration Menu (see page 28), use the UP (▲) and DOWN (▼) arrow buttons to highlight CO, and then press ENTER to display the CALIBRATE CO screen. This requires password validation (see page 28).</p> <div style="display: flex; justify-content: space-around;"> <div style="border: 1px solid black; padding: 5px; width: 45%;"> <p style="text-align: center;">Calibration Menu</p> <p>Temp</p> <p>CO</p> <p>T-Ref</p> <p>B-Smart</p> <p style="text-align: center;">Menu</p> </div> <div style="border: 1px solid black; padding: 5px; width: 45%;"> <p style="text-align: center;">Calibrate CO</p> <p>Measured: 0 ppm</p> <p>Applied: 500 ppm</p> <p>Press ENT</p> <p style="text-align: center;">Print Reset</p> </div> </div> <p>“Measured” is the current CO reading, while “Applied” is a known CO level that will be applied for calibration purposes.</p>
2	<p>Use the UP (▲), DOWN (▼), LEFT (◀), and RIGHT (▶) arrow buttons to enter an Applied value that exactly equals the concentration stamped on the CO cylinder.</p> <hr/> <div style="display: flex; align-items: center;">  <p>NOTE: Bacharach recommends using a 500 ppm calibration gas, however the calibration range is from 20 to 1,000 ppm. An attempt to calibrate outside this range will cause the message “Applied Value High” (or Low) to appear at the bottom of the screen.</p> </div> <hr/>

Step	CO Span Procedure
3	Attach a 500 ppm CO cylinder to the regulator and connect calibration kit components as shown below. Apply 500 ppm carbon monoxide in an air balance calibration gas.
4	<p>Wait until the Measured reading stabilizes and then press ENTER. The message “Good Calibration” should briefly appear.</p> <p>If the sensor’s output is low, but still usable, then the message “Good Calibration WARNING Low Sensor” will appear. The sensor will now be marked as being Low in the Warm-up screen.</p> <p>If the sensor’s output is too low to be usable, then the message “Bad Calibration Sensor End of Life, Entry Not Saved” will appear.</p>
5	Close the regulator and remove the CO cylinder.

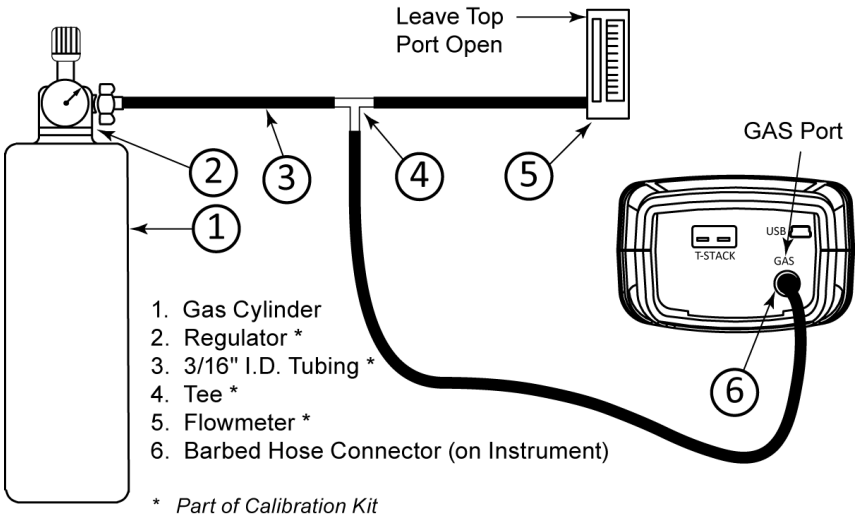

5.7. T-Ref Sensor Calibration

The T-Ref sensor is located inside the instrument. Calibration is done at the factory and should not need to be done in the field.



Section 6. Troubleshooting

6.1. Error and Warning Messages

Message	Description
Low Sensor CO	CO sensor output was low but still usable. Sensor may need to be replaced in the near future.
Low Battery	Battery voltage is low. Replace the batteries.
Applied Value High/Low	An attempt was made to calibrate a sensor outside its range—either above (High) or below (Low) the acceptable range.
Warm-up Sensor Error	<ul style="list-style-type: none"> • CO sensor was not zeroed at warm-up because of high output. Run instrument on fresh air then restart instrument to re-zero sensor. If the message persists, the CO sensor may need to be replaced. • Temperature sensors are measuring temperature outside the range of -4° to 212° F at warm-up. Make sure that the thermocouple is sampling ambient room air within the temperature range at warm-up. • Messages will indicate which sensors are in error.
Set Clock	Time and date values need to be set in the instrument.
X X X	Occurs in the number fields of sensors that have achieved over-range condition.
* * *	Occurs in the number fields of sensors. Replaces in-error sensor values and any calculated values that depend on those sensor values.
- - -	Occurs in the number fields of sensors and indicates that values were not calculated.
Beeping	Slow beep frequency: Replace batteries warning. Fast beep frequency: CO alarm is active and set.



NOTE: If a particular sensor is in error during warm-up, the instrument automatically displays the error. The instrument continues to operate with the sensor in error, however information dependent on the sensor in error is not displayed.

6.2. Replacement Parts

Part Number	Description
0204-0004	Battery, AA Alkaline (qty 1)
0024-7265	CO sensor, uncalibrated
0024-1467	B-Smart [®] CO sensor
0019-7110	Replacement probe assembly with water trap
0019-3265	Replacement water trap for probe assembly 0024-7110
0007-1644	Replacement filter element for probe assembly 0024-7110
0024-1579	Replacement End Plate
0024-3073	Replacement Pump Assembly
0024-1620	Battery door/sensor cover
0024-1484	CO Sensor Cap
0024-1458	CO Sensor Base
0019-9370	Instruction manual

6.3. Accessories

Part Number	Optional Accessory
0024-1400	IrDA printer
0024-1310	Printer paper, box of 5 rolls
0021-7006	True Spot [®] Smoke Tester kit
0104-1798	Thermocouple (temperature, air), K-type (1 inch long)
0104-1797	Thermocouple (temperature, stack), K-type (10 feet long)
0024-7059	CO Calibration kit (no gas)
0024-0492	CO calibration gas, 500 ppm CO
0051-1994	CO calibration gas, 100 ppm CO
0024-1470	PC Software Installer CD
0104-4032	USB cable (A to Mini-B)
0024-1461	Boot , rubber
0024-1505	NO _x filter kit
0024-1504	NO _x filter
0024-8555	Optional Appliance Kit for Ambient CO Test
0019-7111	Optional probe assembly with thermocouple

6.4. Instrument Identification

A label on the back of the instrument provides the following information that is useful for service and troubleshooting.

- manufacturer
- country of origin
- certification(s)
- part number
- serial number

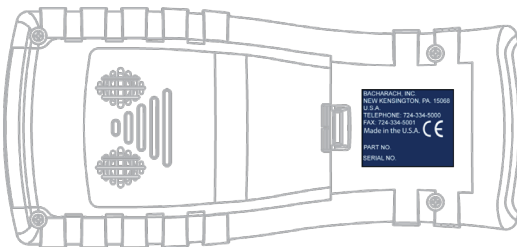

BACHARACH, INC.
NEW KENSINGTON, PA. 15068
U.S.A.
TELEPHONE: 724-334-5000
FAX: 724-334-5001
Made in the U.S.A. 

PART NO.
SERIAL NO.

6.5. Service Centers

Replacement parts and service can be obtained by contacting one of the following Bacharach Service Centers.

United States

Bacharach, Inc.
621 Hunt Valley Circle
New Kensington, PA 15068
Phone: 724-334-5051
Fax: 724-334-5723
Email: help@MyBacharach.com

Canada

Bacharach of Canada, Inc.
20 Amber Street Unit #7
Markham, Ontario L3R 5P4
Canada
Phone: 905-470-8985
Fax: 905-470-8963
Email: Support@BachCan.ca





CE Declaration of Conformity

The manufacturer of the products covered by this declaration:	Bacharach, Inc. 621 Hunt Valley Circle New Kensington, PA 15068
Year conformity is declared:	2013
Product(s):	CO Analyzer
Model(s):	Monoxor® Plus

The undersigned hereby declares that the above referenced product is in conformity with the provisions of the following standards and is in accordance with the following directive.

Directive:

2004/108/EC	EMC Directive
-------------	---------------

Standard(s):

EN 50270: 2006	Electromagnetic Compatibility (Immunity): Electrical Apparatus for the Detection and Measurement of Combustible Gases, Toxic Gases, or Oxygen
----------------	---

Signature:  _____
Name: Doug Keeports
Title: President
Date: June 27, 2013

The technical documentation file required by this directive is maintained at the corporate headquarters of Bacharach, Inc.



World Headquarters

621 Hunt Valley Circle, New Kensington, Pennsylvania 15068

Phone: 724-334-5000 • Toll Free: 1-800-736-4666 • Fax: 724-334-5001

Website: www.MyBacharach.com • E-mail: help@MyBacharach.com

