

Table of Contents

Table of Contents Page 1
 Approvals Page 1
 Attention Page 1
 Specification Page 2
 Model Description & Part Number Page 2
 Operation Page 2
 Pressure Conn. & Mounting GGAO-A4. Page 3
 Installation Position Page 3
 Operation & Adjustment. Page 4
 Wiring Page 4
 Maintenance & Testing Page 5
 Accessories & Replacement Page 5



Approvals



CSA Certified:
 CSA C22.2 No.14
 CSA C22.2 No.0
 UL 508
 File # 2620681

Attention



The installation and maintenance of this product must be done under the supervision of an experienced and trained specialist. Never perform work if gas pressure or power is applied, or in the presence of an open flame.



Check the ratings in the specifications to verify that they are suitable for your application.



Please read the instruction before installing or operating. Keep the instruction in a safe place. You find the instruction also at www.dungs.com. If these instructions are not heeded, the result may be personal injury or damage to property.



On completion of work on the pressure switch, perform a leakage and function test.



Any adjustment and application-specific adjustment values must be made in accordance with the equipment manufacturers instructions.



This product is intended for installations covered by, but not limited to, the following fuel gas codes and standards: NFPA 54 or IFGC (International Fuel Gas Code) or the following equipment codes and standards: NFPA 37, NFPA 85, NFPA 86, ANSI Z83.4/ CSA 3.7, ANSI Z83.18/CSA 4.9, ANSI Z21.13, CSD-1 and UL 795.

Explanation of symbols

- 1, 2, 3 ... = Action
- = Instruction

Specification

GGAO-A4... SPDT gas/gas differential pressure switch in pressure ranges. The differential pressure acts via the diaphragm against the force of the setting spring on the microswitch. The pressure switch operates without any auxiliary power.



Max. Operating Pressure
MOP = 7 PSI (500 mbar)

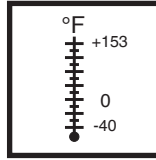

Ambient / Medium Temperature
-40 °F ... +153 °F
(-40 °C ... +67 °C)



Electrical Connection
Screw terminals via 1/2" NPT conduit connection

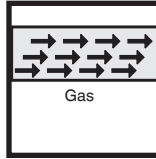

Gases (both + and - connection)
Suitable for natural gas, propane, butane, air & non aggressive gases.

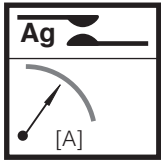

Contact Rating
10 A resistive @ 120 VAC
5 A resistive @ 240 V
1 A max. @ 12 - 48 VDC

Materials in contact with Gas (+ connection)

Housing: Aluminum
Diaphragm: NBR-based rubber

Materials in contact with Gas/Air (- connection)

Housing: Aluminum & Steel
Diaphragm: NBR-based rubber
Switching contact: Gold (Au)

DDC-Application
min. 5 mA @ 5 VDC
max. 20 mA @ 24 VDC



Switch

SPDT

Switch action

Pressure, vacuum of differential pressure switch

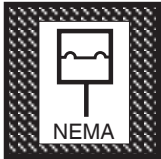

Enclosure
NEMA Type 4

Model Description & Part Number

Type	Version	Description	Order No.	Setting range in. W.C.	Switching hysteresis in. W.C.	Factory Calibration
Gas differential pressure switch	GGAO-A4-4-2	Threaded connection	271329	0.16 - 1.20	≤ 0.12	↑ □
	GGAO-A4-4-3	Threaded connection	271330	0.40 - 4.00	≤ 0.20	
	GGAO-A4-4-5	Threaded connection	271331	2.00 - 20.00	≤ 0.40	
	GGAO-A4-4-6	Threaded connection	271332	12.00 - 60.00	≤ 1.2	

Operation

Definition of switching hysteresis Δp

The pressure difference between the upper and lower switching pressures.

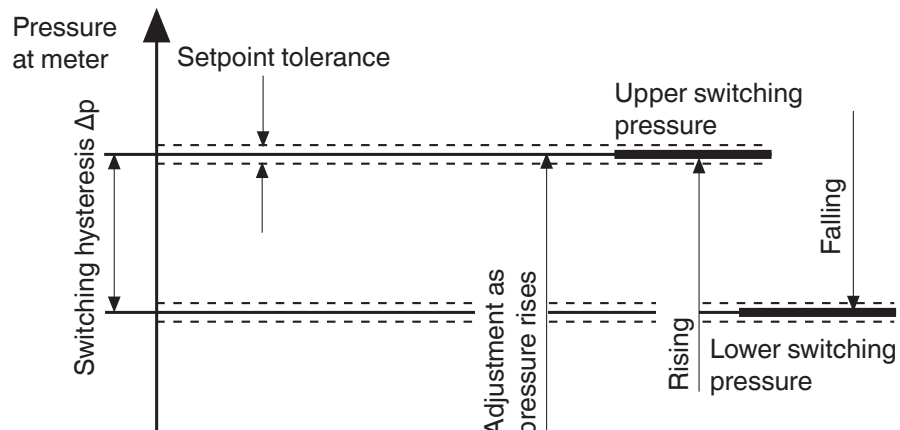

Pressure Conn. & Mounting GGAO-A4

... Threaded Connection

- 1 Pressure connection (+) 1/4" NPT, Gas or Air
- 2 Pressure connection (-) 1/8" NPT, Gas or Air. May also be used as an atmospheric vent connection.
- 3 Test nipple p (+) Ø 0.35" (9 mm), integrated

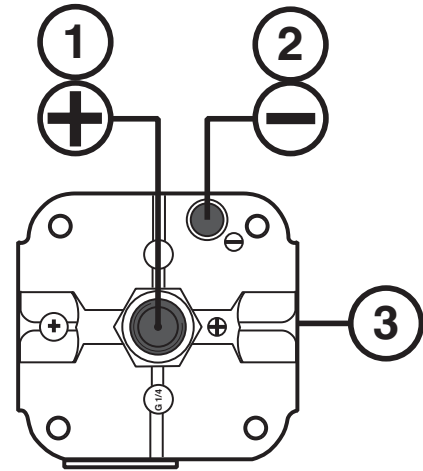

GGAO-A4... Mounting Procedure

- Apply good quality pipe sealant to the male threads only.
- Use 13/16" Wrench to secure the switch to the pipe.
- **DO NOT Exceed 13.2 lb-in of Torque on 1/8" Connections**
- **DO NOT Exceed 17.7 lb-in of Torque on 1/4" Connections**
- After installation is complete, perform a leak test.

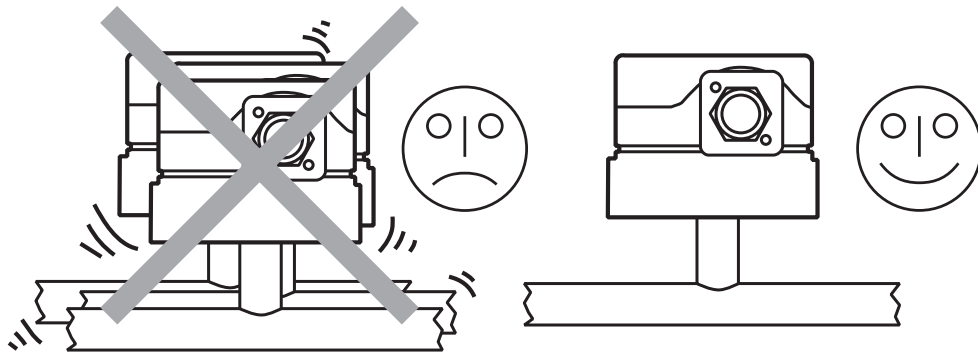

Installation Position

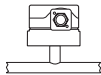
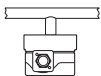
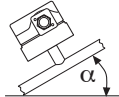
	Standard installation position is vertical upright diaphragm.
	When installed horizontally , the pressure switch switches at a pressure higher by approx. 0.2 in. W.C.
	When installed upside down , the pressure switch switches at a pressure lower by approx. 0.2 in. W.C.
	When installed in other positions , the pressure switch switches at pressure deviating from the set reference value by max. ± 0.2 in. W.C.

Adjustment

The scale indicates the setpoint when switch is mounted in the vertical position and increasing pressure.

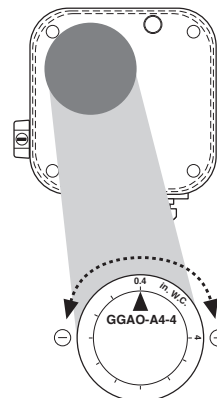

Operation & Adjustment

Adjusting the Set Point

1. Remove the clear cover ❶ from the switch.
2. Adjust the switch to the desired set point by turning the dial. The black arrow on the dial indicates the set point ❷.
3. After adjusting the set point, verify that the pressure switch operates as intended by using an accurate pressure gauge connected upstream of the switch.
4. Replace the clear cover.

Automatic Reset and Operation

The NC contact of the GGAO-A4... breaks when pressure rises above the set point. It makes automatically when pressure falls below set point.

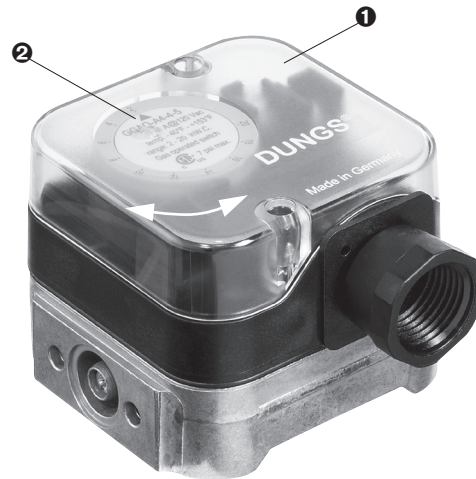

Wiring

1. Remove the clear cover from the switch.
2. Use 14 or 16 AWG wire rated for at least 75 °C.
3. Route the wires through the conduit connector.
4. Connect the wiring to the appropriate screw terminals.
5. Replace the clear cover from the switch.



All wiring must comply with local electrical codes, ordinances and regulations.



Do not exceed the switch ratings given in the specifications and on the switch.

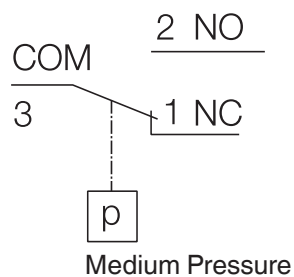

Switching function

As pressure rises above setpoint:

1 NC opens, 2 NO closes

As pressure falls below setpoint:

2 NO opens, 1 NC closes

Maintenance & Testing

Annually check the switch for proper operation

Set Point Calibration

- Connect a meter capable of reading +/- 0.1 ohms to the NC and COM contacts.
- Measure the resistance across the NC and COM contacts. If the resistance is more than 1.0 ohm, the switch should be replaced, since this indicates that the switch contacts are starting to either corrode or carbonizing.

- Apply appressure to the + air pressure connection, and confirm that the NC contact breaks when pressure rises above the set point and that the NO contact makes. the NC contact will make automatically when pressure falls below the set point pressure.
- Connect a meter capable of reading +/- 0.1 ohms to the NO and COM contacts.
- Measure the resistance across the NO and COM contacts. If the resistance is more than 1.0 ohm, the switch should be replaced, since this indicates that the switch contacts are starting to either corrode or carbonizing.

Accessories & Replacement

Accessory for pressure switch	Order No.
Replacement cover (cover, O-ring, 2 screws)	262248
Mounting bracket (metal) (1 pcs)	230288
120 VAC light mounting set (yellow)	231772
24 VDC/VAC light mounting set (yellow)	231774
Replacement conduit adapter M 20 to 1/2" NPT	240671
DIN connector (female plug)	210318
Male plug for DIN connector	219659

We reserve the right to make modifications in the course of technical development.



Karl Dungs, Inc.
3890 Pheasant Ridge Drive NE
Suite 150
Blaine, MN 55449, U.S.A.
Phone 763 582-1700
Fax 763 582-1799
e-mail info@karldungsusa.com
Internet <http://www.dungs.com/usa/>

Karl Dungs GmbH & Co. KG
P.O. Box 12 29
D-73602 Schorndorf, Germany
Phone +49 (0)7181-804-0
Fax +49 (0)7181-804-166
e-mail info@dungs.com
Internet <http://www.dungs.com>