



Installation Guide and Operating Manual
FSX™ Fire and Flame Detectors

Model FS19X™ & FS20X™ Series

FS19X & FS20X WideBand IR™ / UV

Multi-Spectrum Infrared / Ultraviolet Electro-Optical Multi-Spectral Digital
WideBand IR Sensor with Ultraviolet Phototube

Radiant Energy Fire and Flame Detector

**Read and understand this manual before
installing or operating equipment.**

No part of this document may be copied or reproduced without the express written permission of Honeywell Analytics.

This manual is subject to change without notice.

Copyright 2014 by Honeywell International Inc.

While this information is presented in good faith and believed to be accurate, Honeywell disclaims the implied warranties of merchantability and fitness for a particular purpose and makes no express warranties except as may be stated in its written agreement with and for its customers.

In no event is Honeywell liable to anyone for any indirect, special or consequential damages. The information and specifications in this document are subject to change without notice.

ACCTTL, ALERT-1, ALARM-2, ALERT-1: ALARM 2, ALERT-1: ALARM-2, ATAG, Clean Room Sentry, COP-i, Complete Optical Path Integrity, CM1, CM1-A, DartLogic, FireLogic, Fire Signature Analysis, FireBusI, FireBusII, FirePic, FirePicII, FirePicIII, FirePix, FirePicture, FSC, Fire Sentry Corporation, Fire Sentry Corp., FSX, All FSX Nomenclature Variations (such as: FS2, FS2X, FS3, FS3X, FS4, FS4X, FS5, FS5X, FS6, FS6X, FS7, FS7X, FS8, FS8X, FS9, FS9X, FS10X, FS10X, FS11, FS11X, FS12, FS12X, FS14, FS14X, FS15, FS15X, FS16, FS16X, FS17, FS17X, FS18, FS18X, FS19, FS19X, FS20, FS20X, FS24, FS24X, FS24XN, FS26, FS26X, FS26XN), FS7-2173-2RP, FS System 7, FS System 10, FS7-2173, FS7-2173-RP, FS2000, FS System 2000, High Speed Flame & Surveillance Detector, Multi-Spectrum QuadBand Triple IR, Multi-Spectrum TriBand, Multi-Spectrum Tri-Band, Near Band Infrared, Near Band IR, NearBand IR, QuadBand IR, Room Sentry, RS, RS2, SM2, SM3, SS, SS2, SS2X, SS2-A, SS3, SS3-A, SS3X, SS4, SS4-A, SS4X, SnapShot, SLR-BIT, SuperBus, SuperSentry, System 2000, Tri-Mode Plot, QuadBand Triple IR Plus, TriBand, Tri-Band, "FS & FSC triangle logo's", WBIR, Wide Band Infrared, WideBand IR, Wide Band IR

are registered trademarks of Honeywell International Inc.

Other brand or product names are trademarks of their respective owners.

Honeywell Analytics

TABLE OF CONTENTS

	PAGE
SECTION 1: INTRODUCTION	2
1.1 Product Overview	2
1.2 Detector Technical Specifications	3
1.2.1 Mechanical Specifications	3
1.2.2 Electrical Specifications	3
1.2.3 Environmental Specifications	3
1.2.4 Performance Specifications	3
1.2.5 Hazardous Area Classifications	3
1.3 Features & Benefits	3
1.4 Applications	5
SECTION 2: INSTALLATION	6
2.1 Mounting Instructions	6
2.2 Opening the Detector	7
2.3 Detector Connections	8
2.4 Installation Practices	9
2.5 Start-Up and Commissioning	10
SECTION 3: OPERATION	12
3.1 Principle of Operation	12
3.2 Configuring the Detector	12
3.3 Normal Operation	14
3.4 Alarm Condition	14
3.5 Fault Conditions	15
3.6 LED Status Indicators	14
3.7 Maintenance	15
SECTION 4: APPENDIX	16
4.1 Warranty Information	16
4.2 Product Variations	16
4.3 Digital Communication Options	17
4.4 Test Lamps	18
4.5 Field of View Restrictor	17
4.6 Additional Performance Specifications	18
4.6.1 Flame Response Sensitivity	18
4.6.2 High Temperature Response	18
4.6.3 False Alarm Immunity	19
4.7 Drawings	20
4.7.1 Outline and Dimensions	20
4.7.2 Wiring and Terminal Connections.....	21
4.7.3 Detector Label Drawings.....	23
INDEX	25

SECTION 1: INTRODUCTION

1.1 Product Overview

The Model FS19X™/FS20X™ Detector senses the Ultraviolet and WideBand IR™ radiant energy of blackbody particulate and molecular emissions generated by both hydrocarbon and non-hydrocarbon flames and fires. The WideBand spectral radiant energy wavelengths sensed by the Tri (3) sensors span approximately 0.18 to 3.5 microns for the **FS19X/FS20X** Detector.

The Model FS19X/FS20X Multi-Spectrum Fire and Flame Detector is designed and Factory Mutual approved for use in Class I, Division 1 and 2, Class II and Class III, Ex db IIC, Ex tb IIIC Hazardous Locations (see *Figure 1-1*).

The FS19X/FS20X Detector is available in copper-free Aluminum or in 316 Stainless Steel enclosure. The FS19X/FS20X Detector electro-optical electronics module (puck) is enclosed in a replaceable black, hard anodized aluminum puck that provides superior ruggedness, handling, ease of installation, and protection against EMI/RFI.



Figure 1-1
FS19X/FS20X Detector
Shown with Copper Free Aluminum Housing

FS19X/FS20X Detector Field Connectors

The field connections feature two (2) connector choices for the installer:

1. A removable ten (10) pin screw terminal connector (J2) for hardwired relay applications.
2. A removable six (6) pin screw terminal connector (J1) for analog output or RS-485 Digital Communication applications.

The removable connectors provide quicker installation and allows the Detector enclosure to be installed prior to the Detector Module (puck).

UField Selectable Configuration Switches

1. The eight (8) pin DIP switch (SW2) is used to select the Detector's Sensitivity and Relay Options.
2. The ten (10) pin DIP switch (SW1) is used for:
 - Selecting a unique digital address (128 choices).
 - Enabling "Fireball" type fire response
 - Factory Use
3. The ten (10) position Rotary switch allows selection of the analog and digital communication protocol.



Figure 1-2
FS19X/FS20X Detector Puck, (rear view)

1.2 Detector Technical Specifications

1.2.1 Mechanical Specifications

Enclosure Material:	Copper Free Aluminum (white) 316 Stainless Steel
Physical Dimensions:	Assembly 4.35 in. (110.49 mm) Height X 4.81 in. (122.24 mm) Diameter Mounting Holes ¼ in. (6.35 mm) Diameter, 5.50 in. (139.70 mm) Center to Center Conduit Entries Two (2) ¾ in. NPT or Two (2) 25 mm
Weight:	Aluminum 3 lbs. 11 oz. (1.7 kg) approximately Stainless Steel 7 lbs. 7 oz. (3.4 kg) approximately
Enclosure Rating:	IP66 / NEMA 4 / NEMA 4X
Vibration:	Meets or exceeds Mil Spec 810C, Method 514.2, Curve AW

1.2.2 Electrical Specifications

Input Voltage Range:	18 VDC to 32 VDC
Normal Operation Current:	85 mA (nominal) 175 mA (nominal with heater ¹)
Maximum Fire Alarm Current:	135 mA (maximum) 220 mA (maximum with heater ¹)
Relay Contact Rating:	1 Amp @ 24 VDC resistive
Analog Current Output: (400 Ohms Max Load [loop resistance])	0.0 to 20.0 mA (Non-Isolated Source or Sink, User Selectable) 0.0 mA (<0.6 mA) = Fault 2.0 mA (±0.6 mA) = Dirty Window Lens 4.0 mA (±0.6 mA) = Normal, Safe (no Fault, no Fire) 8.0 mA (±0.6 mA) = Background IR 12.0 mA (±0.6 mA) = Background UV 16.0 mA (±0.6 mA) = Fire Alarm 20.0 mA (±0.6 mA) = Verified Fire Alarm
Screw Terminal Wire Sizes:	12 AWG to 22 AWG (2.50 mm to 0.762 mm) <i>Use stranded conductors (<u>not</u> solid core)</i>

1.2.3 Environmental Specifications

Operating Temperature	Standard: -40° F to +185° F (-40° C to +85° C) Extended-Temp ² : -58° F to +230° F (-50° C to +110° C) <i>Optional</i>
Operating Humidity Range:	0 to 95% RH, 100% RH condensing for short periods of time
Storage Temperature:	-67° F to +221° F (-55° C to +105° C)

1.2.4 Performance Specifications²

Field of View:	110° Horizontal and 105° Vertical
Sensitivity	One (1) sq. ft. heptane fire at 200 feet (± 45° from axis)
Speed of Response:	Typically, 2 to 5 seconds
High Speed Response:	Less than 0.5 seconds to “fireball” type fires
Spectral Sensitivity	0.18 to 3.5 micron wavelengths

1.2.5 Hazardous Area Classifications (See Section 4.7.3 on Pages 22 & 23)

Class I, Division 1, Groups A, B, C & D	Class I, Zone 1, AEx / Ex d IIC
Class II, Division 1 Groups E, F & G	Ex db IIC, Ex tb IIIC
Class III	
T4: Ta = -40°C to +110°C ³	T4: Ta = -40°C to +110°C ³
T5: Ta = -40°C to +75°C ³	T5: Ta = -40°C to +75°C ³
T6: Ta = -40°C to +60°C	T6: Ta = -40°C to +60°C

¹ Heater circuit turns ON only when temperature drops below zero degrees Fahrenheit (-17° C)

² See Section 4.6 for Additional Performance Specifications

³ The supply connection wiring shall be rated at least 10°C above the rated service temperature (120°C for T4 applications and 85°C for T5 applications)

1.3 Features and Benefits

- **Selectable Sensitivity (four settings)**
User can set an F20SX Detector to four (4) different detection distances (see Section 3.2).
- **Selectable Relay Options**
User can be configured for a variety of dry contact relay interface options (see Section 3.2).
- **Selectable 4 – 20 mA Output**
User can set for Source or Sink output (see Section 3.2).
- **Selectable Communications**
User can configure for analog or digital communication outputs such as ModBus (see Section 3.2).
- **Selectable Digital Communication Address**
Users can select unique 7-bit code (128 addresses) (see Section 3.2).
- **Lower Power Consumption**
Requires smaller external power supplies and fewer system backup batteries.
- **Multiple Microprocessors**
Reduces the number of discrete Detector components, provides larger programming and memory capacity, and provides redundant self-checking.
- **Wider Range of Applications**
Primary applications include long range, fast response to fires such as acetylene, silane, hydrogen, etc.
- **Wider Operating Temperatures**
-40°F to +185°F (-40°C to +85°C) Standard and -76°F to +230°F (-60°C to +110°C) Optional.
- **Built-In Automatic “Through-the-Lens” Self-Test**
Monitors window lens obscuration and checks the operation of the Detector’s Sensor Array and Electro-Optical Electronics Module with Built-In IR (FS19X & FS20X) and UV (FS20X) Self-Tests.
- **Anodized Removable Detector Aluminum Module (Puck)**
Rugged, superior protection against EMI/RFI and handling plus easier field installation and replacement.
- **Three Separate Bright LED’s (Red, Yellow, Green)**
Field status indicators with individual LED’s for Alarm, Fault and Normal conditions. Provides superior Detector status viewing in bright outdoor environments (see Section 3.6).
- **FSC Windows® based PC Interface**
User can perform remote FS20X Detector diagnostics, real-time status, Real-Time Graphing (RTG™), SnapShot™ data recording, and downloading FirePic’s™ with Honeywell Analytics’ exclusive FSIM-2 USB Interface Unit and easy to use Windows® based PC Software.
- **Designed to Detect both Hydrocarbon and Non-Hydrocarbon Fires with one FSX™ Detector**
All fire and flame threats are sensed, not just hydrocarbon fires as with other Triple IR Flame Detectors.
- **FM 3260 Approved**
Third party tested and certified for industrial and commercial applications.
- **Designed, Manufactured, and Tested by Honeywell Analytics**
Over 25 years of proven fire / flame detection product excellence worldwide.

1.4 Applications

The applications for the FS19X/FS20X Fire and Flame Detectors are vast. Here is a partial list:

Refineries

Offshore Drilling and Production Platforms

Petrochemical Plants

Petroleum Product Pipelines and Pumping Stations

Gas Compressor Buildings

Gas Collection Facilities

Gas Processing Plants

Gas Turbine Enclosures

Gasoline Loading Terminals

LNG Storage/Distribution

LPG Storage/Distribution

Cogeneration Plants

Crude and Product Tank Farms

Aerosol Filling Facilities

Commercial and Military Aircraft Hangars

Engine Test Cells

Marine Engine Rooms

Marine Terminals

Paint and Solvent Storage

Power Plants

Product Storage Terminals

Rail and Truck Loading and Unloading Terminals

Silane Gas Cabinets

Silane Gas Manufacturing

Hydrogen Plants

Hydrogen Storage

General Warehouses

SECTION 2: INSTALLATION

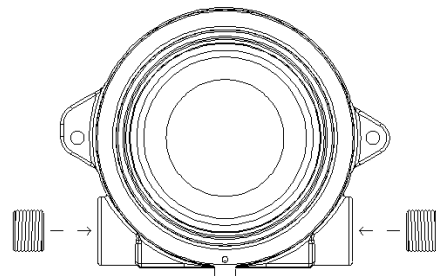
2.1 Mounting Instructions

Consider the following guidelines when selecting Detector location:

1. As with all flame and fire Detectors, avoid areas that contain radiant energy sources (such as radiant heaters, high intensity lamps, flare-stacks, etc.) in close proximity to the Detector's field of view.
2. Detectors should not be mounted so that they look up or face the horizon (especially outdoors). Use a minimum thirty degrees (30°) downward angle with the SM4 swivel mount (see Figure 2-1).
3. Make sure the Detector has a clear, unobstructed view of the threat area. Physical obstructions between a fire and the Detector may cause the fire to be undetected.
4. The Model SM4 is a 316 Stainless Steel Swivel Mount designed for the FSC Detector housing. The adapter plate, with the two (2) screw holes (facing away), is attached to the base of the Detector (see Figure 2-1). The mounting plate, with the four (4) screw holes (facing towards), is used for mounting the SM4 to a solid surface. Each adjustment increment along an axis is calibrated to 10°. For single axis adjustments, the center section need not be installed.
5. Avoid mounting the Detectors in areas where temperatures exceeds the specified operating temperature range (see Sections 1.2.3 & 1.2.5).
6. Detector Conduit Entries
 - a) If only one conduit entry is used, correctly install and seal the conduit plug on the unused entry, $\frac{3}{4}$ in. NPT or 25mm (see Figure 2-2).
 - b) Install an approved conduit trap or drain, if required to meet hazardous area classifications per NFPA 70: National Electrical Code, latest revision.

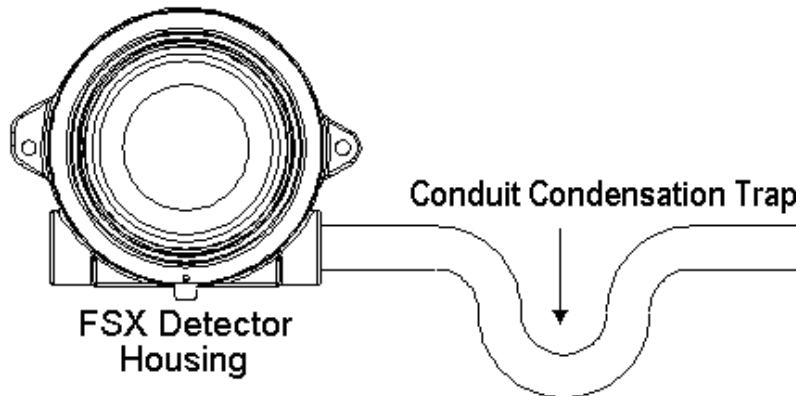


Figure 2-1
Swivel Mount



3/4 in. NPT or 25 mm Conduit Entries

Detector (front view)
Figure 2-2



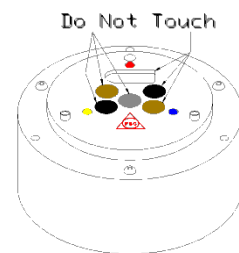
FSX Detector
Housing

Figure 2-3

Mounting Instructions (continued)

Note the following Precautions:

1. ***Do not touch*** the sensors' windows on the front of the Detector electro-optical electronics module (puck). If touched accidentally, they should be cleaned following the instructions listed below (see *Figure 2-4*).
2. When cleaning the Detector's sensor windows on the puck, it is best to use Alcohol or IPA sparingly and a cotton swab.
3. There are no serviceable parts inside the Detector puck. If the puck is opened up or tampered with, all warranties are voided.



Detector Module "puck"
Figure 2-4

CAUTION: Follow static protection procedures while handling the connectors and the wiring of the Module puck to the Detector. Use a wrist strap connected to earth ground.

2.2 Opening the Detector

It is necessary to remove the Detector Module "puck" from the enclosure to access the field connections.

CAUTION: Disconnect power before unscrewing the Housing Lid.

4. Loosen the set screw on the enclosure lid (see *Figure 2-5*).

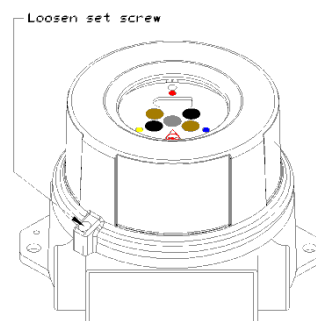


Figure 2-5

5. Turn counterclockwise (CCW) to unscrew the enclosure lid (see *Figure 2-6*).

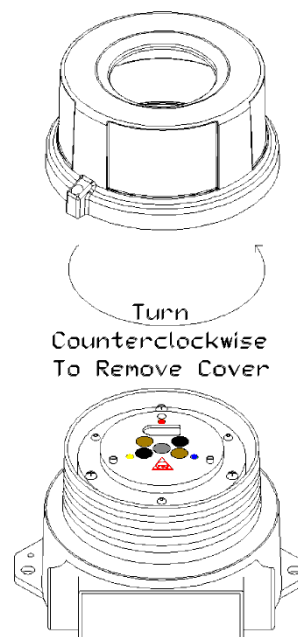


Figure 2-6

Opening the Detector (continued)

- Loosen the three captive screws on the Detector Module “puck” (see Figure 2-7).

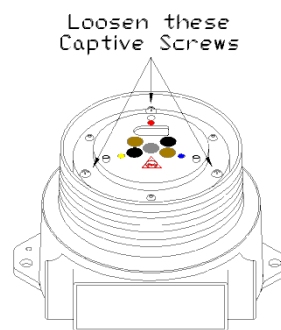


Figure 2-7

- Slide the Detector Module “puck” out of the enclosure base (see Figure 2-8).

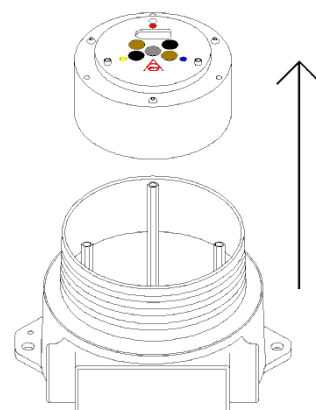


Figure 2-8

2.3 Detector Connections

The Detector Module puck has a six (6) pin and a ten (10) pin keyed removable connector with screw terminal female plugs that connect to the two (2) respective male connectors with analog, digital, and relay interfaces (see Figure 2-9):

- For **relay configurations**, use the ten (10) pin plug (J2) and its connector.
- For **digital and analog configurations**, use the six (6) pin plug (J1) and its connector.

J2 Connector	
Pin	Connection
1	Auxiliary NC
2	Auxiliary NO
3	Auxiliary COM
4	Alarm NC
5	Alarm NO
6	Alarm COM
7	Fault NO
8	Fault COM
9	+24 VDC
10	DC Return

Contacts shown with no power applied



Figure 2-9

Detector Module “puck” (rear view)

J1 Connector	
Pin	Connection
1	DC Return
2	RS-485-A
3	RS-485-B
4	+24 VDC
5	4-20mA Source
6	4-20mA Sink

Note: Do not attempt to open the Detector Module “puck” as this voids all warranties.

Detector Connections *(continued)*

ATTENTION: FSX Power-Up – After the application of 24 VDC power or resetting the Detector, wait a minimum of (thirty) 30 seconds to allow the Detector’s sensors to normalize to the spectral background conditions.

FSX Testing - As with any intelligent IR Detector, please wait a minimum of thirty (30) seconds between tests (i.e., butane lighter, FSC test lamp, or test fires) to allow the Detector’s sensors to normalize to the spectral background conditions.

Changing the Detector Settings – To activate changes to the settings using SW1, SW2 and SW3, reset the Detector by removing and re-applying 24 VDC input power.

1. Make sure that the external 24 VDC power is turned **OFF** before connecting the Detector.
2. Avoid wire splices. However, if wire splices are required, all splices should be soldered and properly insulated. The use of good wiring practices will simplify installation, improve reliability and facilitate maintenance.
3. For applications requiring analog/digital communications, please refer to Section 3.2 of this instruction manual.

2.4 Installation Practices

For installations in a Hazardous Classified Area, consult the National Electric Code Handbook, Articles 500 through 517 for the proper installation practices. For locations outside of the United States, observe local and/or regional regulations.

IMPORTANT: The Detector’s metal conduit plug by itself cannot make a weather tight seal. Metal-to-metal does NOT provide protection against the ingress of moisture. It is necessary to obtain an approved material to apply to the threads in order to maintain the “weather-proof” integrity and satisfy local/regional regulations.

Before completing the installation, check that the Detector is configured correctly for the specific application. The FSX Detectors Factory Default Settings are:

Alarm Relay Outputs are Non-Latching and Normally De-Energized	SW2-1 OFF	SW2-7 OFF
Detector Range / Sensitivity is Medium	SW2-2 OFF	SW2-3 ON
Auxiliary Relay Verify Time is set to 5 Seconds	SW2-4 ON	SW2-5 ON
FACTORY USE ONLY	SW2-6 OFF	
Fault Relay Output is Normally Energized	SW2-8 ON	
Communication is set to FireBusII	SW3 is set to Position 4	
Factory Use Only	SW1-1 through SW1-3 OFF	
Digital Communication Address is set to 127	SW1-4 through SW1-10 ON	

If the application for the Detector requires different settings, refer to Section 3.2 for detailed descriptions.

Before applying 24 VDC power to the Detector, make sure:

1. Wire connections are correct (Section 2.3). Each wire must be stripped properly to the correct length, loose wire strands must be removed and each wire must be securely and firmly screwed clockwise in the connector.
2. If using conduit, ensure a proper conduit seal, (appropriate for the area classification), has been installed and ***all measures to prevent moisture ingress have been taken.***
3. The FSX Detector is securely mounted and has an unobstructed view of the area of coverage (Section 2.1).
4. The Detector window is unobstructed and clean.

The Detector is now ready for Power-Up. **On Power-Up, the Fault Relay will change status if the Factory Default Setting is used (Section 3.2).**

2.5 Start-Up and Commissioning

During Start-Up and Commissioning, **DISABLE** all outputs from the Detector to any control panels or control devices. After the Detector(s) is powered, as with all flame and fire detectors, one should conduct an external Detector test "end to end". Using an external hand-held test lamp ensures that the Detector has a clear unobstructed view of the threat area.

Note: Honeywell Analytics FSX Detectors feature an automatic built-in "through the lens" test that verifies the cleanliness of its viewing window lens every three seconds and tests its internal electronics and software. As with all optical fire and flame detectors, this does not constitute a fully functional "end to end" test as these types of internal self-tests only partially check and test the operational readiness of a detector.

In order to test the full functionality and operational readiness of any fire or flame detector "end to end", without starting a real fire (which is not permitted in hazardous areas), it is necessary to test the detector(s) with an external test lamp

Using a test lamp is the only non-hazardous and safe method to test any flame or fire detector's sensors, internal electronics and its alarm activation software, viewing window lens cleanliness, terminal wiring integrity, actual relay activation, and the proper functionality of any other outputs that are used. Also, since most detectors are installed in a fire alarm system, this is the only method to test the complete fire alarm system, ensuring all the system wiring and cabling and system control panel are properly installed.

Additionally, using an external test lamp eliminates the following detector conditions:

1. The fire or flame detector(s)' viewing lens being covered up (such as paint, paint over spray, paint masking material, hanging garments, etc.),
2. Improperly positioned and orientated for coverage of the threat area,
3. Partial or full blockage of the detector's line of sight by one or more object(s) (i.e., recently installed air ducts or pipes, storage boxes, vehicles, etc. such that the threat area is not fully protected. Since all optical fire and flame detectors are line-of-sight devices, they must be properly positioned and oriented with an unobstructed view of the threat area so that they can detect flames/fires.

To test the full functionality of the FSX Detector, use the Model TL1055X or TL2055X Test Lamp in the manner prescribed in this Instruction Manual.

WARNING: Use test lamp model TL1055s in *non-hazardous* locations only! For hazardous locations, use models TL2055 or TL2145, as described below.

The TL1055X and the TL2055X are the only Test Lamps that will activate the FSX Detectors. Additionally, do not use these Test Lamps to activate other Honeywell Analytics Detectors (nor any other conventional fire and flame detectors). Do not use other Honeywell Analytics Test Lamps to test the FSX Detectors.



Figure 2-12
TL1055X Hand Held Test Lamp (NEMA 1)

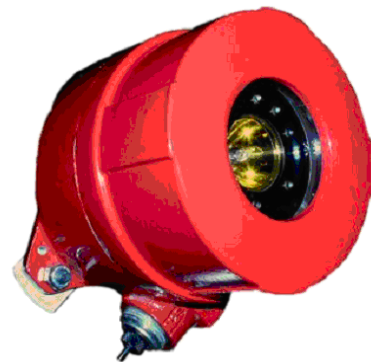


Figure 2-13
TL2055X Hand Held Test Lamp for Hazardous Areas
FM, CFM, FM-ATEX Approved

Start-Up and Commissioning *(continued)*

Remember to disable the outputs, as a full functional test includes activating the ALARM outputs. A Honeywell Analytics Test Lamp must be used for this test (Section 4.4). Point the Test Lamp directly at the front of the Detector (on axis as much as possible, within a distance of about 1 to 25 feet). Activate the Test Lamp by pressing and holding its pushbutton. While watching the ALARM LED on the face of the Detector, slowly move the Test Lamp's boresight to ensure the Detector receives its full intensity. **(NOTE: Practicing this technique may help to optimize testing of the FSX Detectors)**. (Sections 3.6 and 4.4). The Detector's ALARM LED will illuminate, usually within three (3) to ten (10) seconds. Also, the ALARM Relay outputs will activate and the 4-20 mA analog output will increase to 20 mA (± 0.6 mA).

If the Detector fails to respond within ten (10) seconds, do the following:

1. Wait ten (10) to twenty (20) seconds before performing another test.
2. **Check the Distance:** verify that the testing distance is between one (1) and twenty-five (25) feet from the FSX Detector(s).
3. **Check Aiming Accuracy:** verify that the proper testing technique (as described above) is followed.

SECTION 3: OPERATION

3.1 Principle of Operation

Honeywell Analytics' Multi-Spectrum, Multi-Spectral and MultiBand™ Infrared and Ultraviolet Fire and Flame Detectors are sophisticated, state of the art, electro-optical digital radiant energy Detectors that sense the wideband radiant energy emitted by fire's combustion processes that include flames' molecular emissions and hot particulate blackbody emissions. Radiant Energy Fire Detectors respond much faster to flames and fires at a longer distance than other types of conventional photoelectric and ionization smoke and heat detectors because a fire's emitted radiant energy travels at the speed of light. High speed of response is critical for detecting flaming fires in time to successfully activate suppression or activate other fire responses such as closing fire doors. Seconds can make the difference between suppressing a small fire with little or no damage or having a disastrous fire that overwhelms a suppression system thereby failing to stop the fire.

Infrared (IR) consists of spectral wavelengths longer than the color red and Ultraviolet (UV) consists of wavelengths shorter than the color violet. For the FS19X/FS20X Detector, the UV and IR range for fire detection, which a large portion of the spectrum is invisible to the human eye, is from approximately 180 to 3000 nanometers (0.18 to 3.0 microns). Honeywell Analytics' Detectors sense and measure the radiant energy generated by a fire at the speed of light.

Honeywell Analytics' FSX Fire Detectors also use an additional spectral region, the Visible Band, that spans from about 400 to 700 nanometers (0.4 to 0.7 microns.) The Visible Band is used to further discriminate against non-fire false alarm sources. The Model FS19X/FS20X Detector senses radiant energy coming from hydrocarbon and non-hydrocarbon fires. Built-in microprocessors use sophisticated Digital Signal Processing (DSP) to accurately distinguish radiant energy from a real fire and a false alarm source(s). Honeywell Analytics has developed and refined these complex proprietary and patented WideBand IR and UV algorithms for over a quarter of a century since 1981. These patented algorithms perform real-time DSP, and precisely analyze the signals in high-resolution frequency and time domains. This decision making process involves thousands of real-time calculations every second. Honeywell Analytics FSX Detectors use solid-state high speed quantum sensors (not heat sensors such as pyroelectric or thermopile) that all respond to the fire's radiant energy emissions. The quantum sensors convert the rate of photonic energy directly into analog electrical signals. These analog signals are converted to high resolution digital values for real-time microprocessor analysis.

The Detector microprocessors incorporate random access memory (RAM), read-only memory (ROM), and non-volatile flash memory. When the microprocessors determine that a real fire has been detected, the pre-alarm digital sensor data (FirePic™) and the event information are recorded in flash memory. Depending on the configuration, other actions may include activating one or more status LEDs, relays, a current loop and sending digital data such as the RS-485 FireBusII™, and ModBus. If the microprocessors determine, based on internal testing and "through-the-lens" testing, that the Detector is not operating correctly, it records the Fault data in flash memory and activates the Fault outputs and the yellow status LED. The digital data in the Detector can be easily accessed with a PC for later analysis and record keeping using Honeywell Analytics' Windows® based PC software and FSIM-1A USB Interface Unit.

3.2 Configuring the Detector

IMPORTANT: Changing the Detector Settings – To activate changes to the settings using SW1, SW2 and SW3, reset the Detector by removing and re-applying 24 VDC input power.

The Digital Address for the RS485 Communication can be set using positions 4 through 10 on SW1. Switch positions 1, 2 & 3 for SW1 are for factory use only and should not be changed.



Figure 3-1 (SW1)
Ten (10) Position DIP Switch

	1	2	3	4	5	6	7	8	9	10
127	OFF	OFF	OFF	ON	ON	ON	ON	ON	ON	ON
126	OFF	OFF	OFF	ON	ON	ON	ON	ON	ON	OFF
125	OFF	OFF	OFF	ON	ON	ON	ON	ON	OFF	ON
124	OFF	OFF	OFF	ON	ON	ON	ON	ON	OFF	OFF

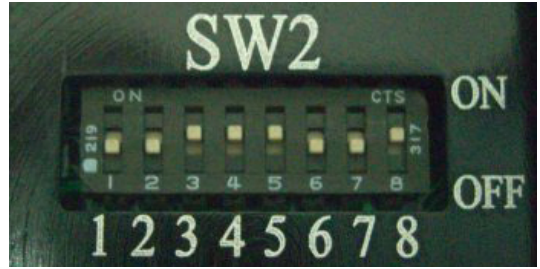
003	OFF	OFF	OFF	OFF	OFF	OFF	OFF	OFF	ON	ON
002	OFF	OFF	OFF	OFF	OFF	OFF	OFF	OFF	ON	OFF
001	OFF	OFF	OFF	OFF	OFF	OFF	OFF	OFF	OFF	ON
000	OFF	OFF	OFF	OFF	OFF	OFF	OFF	OFF	OFF	OFF

Configuring the Detector (continued)

CAUTION - WARNING

When the switches SW1, SW2, or SW3 are changed, the Detector's input power must be cycled OFF, then ON, in order for the change(s) to be accepted.

Eight (8) position DIP Switch (SW2) - Figure 3-2



Use the following table to configure the Detector:

Alarm Relay	SW2-1
Latching	ON
Non-Latching	OFF

Sensitivity Levels		SW2-2	SW2-3
Very High	(4)	ON	ON
High	(3)	ON	OFF
Medium	(2)	OFF	ON
Low	(1)	OFF	OFF

Auxiliary Relay		SW2-4	SW2-5
No Verify Time		ON	ON
5 Sec Verify Time		ON	ON
10 Sec Verify Time		OFF	ON
20 Sec Verify Time		OFF	OFF

Factory Use Only		SW2-6
		OFF

Factory default settings are shown with a gray background.

Alarm Relay	SW2-7
Energized	ON
De-Energized	OFF

Fault Relay	SW2-8
Energized	ON
De-Energized*	OFF

*If the Fault Relay to set to "De-Energized", the Detector will not report any faults due to loss of input power to the Detector.

Analog and digital outputs are available in addition to relay outputs. Select from two (2) analog outputs or two (2) digital outputs using a ten (10) position Rotary Switch (SW3). FireBusII is the factory default setting. Use Table on the right and Figure 3-3 to configure SW3.



Position	Output Selection
0	4-20 mA Sink
1	4-20 mA Source
2	RS-485 ModBus
3	Factory Use Only
4	RS-485 FireBusII
5	Factory Use Only
6	Factory Use Only
7	Factory Use Only
8	Factory Use Only
9	Factory Use Only

Figure 3-3 SW3
Ten (10) Position Rotary Switch

3.3 LED Status Indicators

The Model FS19X/FS20X Detector uses three (3) separate, bright LED's to indicate the Detector's status.

- The **Green** LED blinks (flashes) once every ten (10) seconds to indicate a Normal, safe operational condition (i.e. no Faults and no Alarms). The Green LED is OFF when no external 24 VDC input power is applied to the Detector.
- The **Red** LED turns ON when a fire is Alarmed.
- The **Yellow** LED blinks (flashes) when the window lens is dirty. For all other Fault conditions, the Yellow LED will turn ON.

3.4 Normal Operation

In **Normal** operation, the bright **Green LED** blinks (flashes) every 10 seconds. See Figure 3-4 for the location of the **Green LED**. Normal Operation is defined as the Detector with 24 VDC applied and no **Alarm** or **Fault** conditions are present. If one of the 4-20 mA options are selected (Table 3-1), the current, sink or source, will be 4.0 mA (± 0.06 mA).

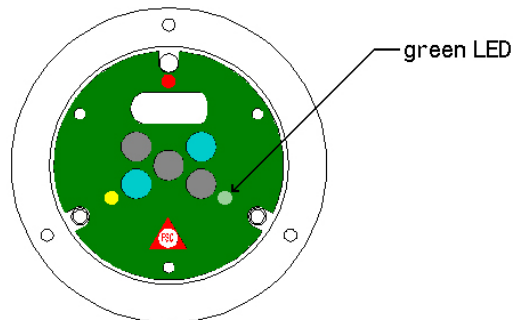


Figure 3-4
Green LED Location

3.5 Alarm Condition

When an **Alarm** condition occurs, the **Red LED** will turn **ON**, (factory setting with the **Auxiliary** relay set to "0" seconds). See Figure 3-5 for the location of the **Red LED**.

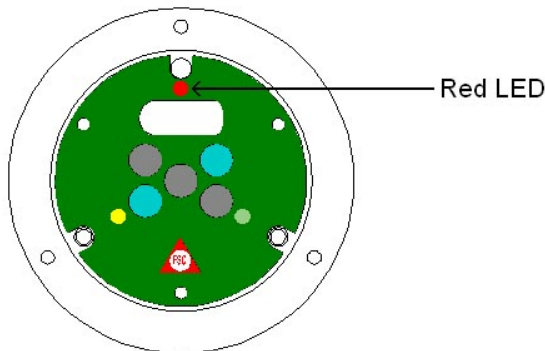


Figure 3-5
Red LED Location

The Detector has the following outputs with an **Alarm** condition:

- Alarm Relay activation
- Auxiliary Relay activation¹
- 4-20 mA (sink 16 mA) Alarm Output²
- 4-20 mA (source 16 mA) Alarm Output²
- 4-20 mA (sink 20 mA) Auxiliary Output²
- 4-20 mA (source 20 mA) Auxiliary Output²
- RS-485 FireBusII Alarm Notification²
- RS-485 ModBus Alarm Notification²

¹ This output is a Verified Alarm Output

² Only one active **Alarm** output from this group

3.6 Fault Conditions

When a **Fault** (Trouble) condition occurs, the **Yellow LED** will illuminate. See Figure 3-6 for the location of the **Yellow LED**.

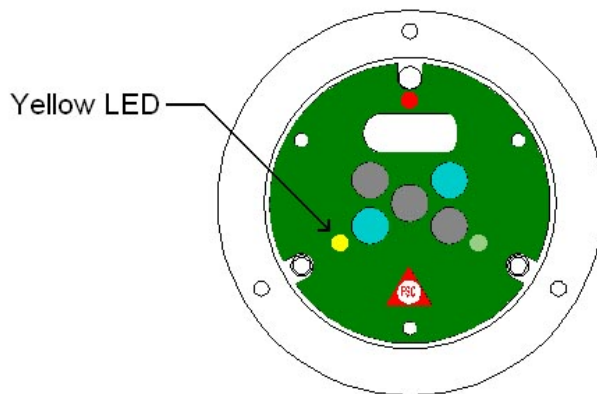


Figure 3-5
Detector Module, Front View

The Detector has the following outputs with a **Fault** condition:

- Fault Relay activation
- 4-20 mA (sink) Output³
2 mA (Self-Test/Lens Obscuration Fault)
0 mA (All Other Faults)
- 4-20 mA (source) Output³
2 mA (Self-Test/Lens Obscuration Fault)
0 mA (All Other Faults)
- RS485 FireBusII Fault Notification³
- RS-485 ModBus Fault Notification³

³ Only One Active **Fault** output from this group

Fault (Trouble) conditions can be caused by:

- Under Voltage Input Power (< 18 VDC).
- Over Voltage Input Power (> 32 VDC).
- Over Temperature (> 85° C or 185° F for the Standard Version).
- Over Temperature (> 110° C or 230° F for the Extended Temperature Version).
- Under Temperature (< -40° C or -40° F for the Standard Version).
- Under Temperature (< -50° C or -58° F for the Extended Temperature Version).
- One or more Microprocessor Failures.
- One or more Relay Coil Failures.
- Communication Fault.
- Electronic Self-Test Failure.
- Dirty Window Lens (**Yellow LED** flashes, the **Yellow LED** is ON [solid] for all other Faults).

3.7 Maintenance

After the FS19X/FS20X Detector is installed and commissioned, there is little maintenance required. However, a complete “end-to-end” test of the entire fire detection system should be performed periodically depending on the application. Additionally, semi-annual or quarterly testing should be performed, using the correct Honeywell Analytics Test Lamp, to ensure the integrity of the entire fire protection system.

The optical window (lens) of the Model FS19X/FS20X Detector should be clean in order to ensure the Detector is operating properly at all times. It may be necessary to establish a periodic cleaning schedule. Some industrial environments may necessitate more frequent cleaning of the Detector’s optical surfaces than others.

Clean the window of the FS19X/FS20X Detector each time the housing lid is handled, the window appears dirty or contaminated, fails the Built-In-Test, or the Detector fails an end-to-end test with the FSC hand-held portable Test Lamp (TL-1055X or TL-2055X). If necessary, clean the Detector Module Sensors each time the Detector has been disassembled for wiring or replacement.

Use a blast of clean air or an oil-free cloth to clean the enclosure window. Oil degrades the performance of UV Detectors. Occasionally, the use of a solvent, such as alcohol is acceptable. No disassembly of the Detector is required.

DO NOT USE SILICONE-BASED OR COMMERCIAL WINDOW CLEANING PRODUCTS.
THESE WILL DEGRADE THE MODEL FS20X DETECTOR PERFORMANCE.
WARNING – Potential Electrostatic Charge, wipe enclosure only with a damp cloth

SECTION 4: APPENDIX

4.1 Warranty Information

Honeywell Analytics warrants its Products against defects in material and workmanship under normal use and service for a period of three (3) years from the date of shipment as described herein. Honeywell Analytics, at its option, will repair or replace, at no charge, such products found to be defective during the warranty period provided that they are returned in accordance with the terms of this warranty. Replaced parts or boards are warranted for the balance of the original applicable warranty period. All Replaced parts of Products shall become the property of Honeywell Analytics. This express limited warranty is extended by Honeywell Analytics to the original purchaser only and is not assignable or transferable to any other party. This is the complete warranty for the Products manufactured by Honeywell Analytics. Honeywell Analytics assumes no obligations or liability for additions or modifications to this warranty unless made in writing and signed by an officer of Honeywell Analytics. Honeywell Analytics does not warrant the installation, maintenance or service of its Products. Honeywell Analytics is not responsible in any way for ancillary equipment not furnished by Honeywell Analytics, which is attached to or used in connection with its Product(s), or for operation of the Product(s) with ancillary equipment and all such equipment if expressly excluded from this warranty. This warranty sets forth the full extent of Honeywell Analytics' responsibility regarding the Products' repair or replacement at Honeywell Analytics' options, is the exclusive remedy.

This Warranty is given in lieu of all other Express Warranties, Implied Warranties, including without limitation, Implied Warranties of Merchantability and fitness for a particular purpose, are limited to the duration of this Limited Warranty. In no other event shall Honeywell Analytics be liable for damages in excess of the purchased price of the product(s), for any loss of use, loss of time, inconvenience, commercial loss, lost profits or savings or other incidental, special or consequential damages arising out of or in connection with the use or inability to use such product, to the full extent such may be disclaimed by law.

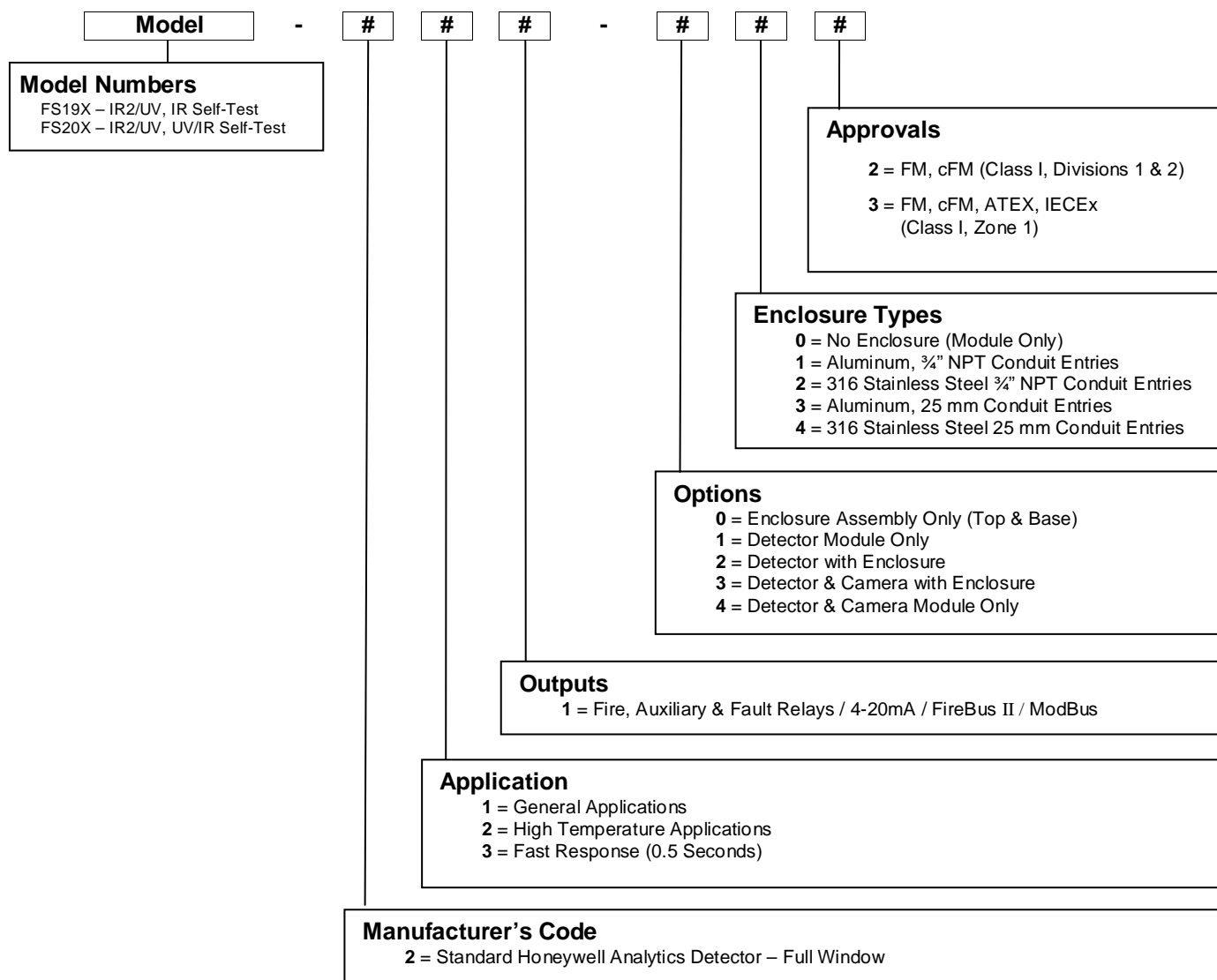
THIS WARRANTY DOES NOT COVER:

1. Defects or damage resulting from use of the Product(s) in other than its normal and customary manner.
2. Defects or damage from misuse, accident, or neglect.
3. Defects or damage from improper testing, operation, maintenance, installation, alteration, modification or adjustment.
4. Product(s) subject to unauthorized Product modifications, disassemblies or repairs (including, without limitation, the audition of the product of non-Honeywell Analytics supplied equipment) which adversely affect performance of the Product(s) to interfere with Honeywell Analytics' normal warranty inspection and testing of the Product(s) to verify any warranty claim.
5. Product(s) that have had the serial number removed or made illegible.
6. Freight cost to the repair facility.
7. A Product which due to illegal or unauthorized alteration of the software/firmware in the Product, does not function in accordance with Honeywell Analytics' specifications.
8. Scratches or other cosmetic damage to Product surfaces that do not affect the operation of the Product.
9. Normal and customary wear and tear.

Laws in the United States and other countries preserve for Honeywell Analytics certain exclusive rights for copyrighted Honeywell Analytics software/firmware, such as the exclusive rights to reproduce in copies and distribute copies of such Honeywell Analytics software/firmware. Honeywell Analytics software/firmware may be used only in the Product(s) in which the software/firmware was originally embodied and such software/firmware in such Product(s) may not be replaced, copied, distributed, modified in any way, or used to produce any derivative thereof. No other use including, without limitation, alteration, modification, reproduction, distribution, or reverse engineering of such Honeywell Analytics software/firmware or exercise or rights in such Honeywell Analytics software/firmware is permitted. No license is granted by implication, estoppel or otherwise under Honeywell Analytics patent rights or copyrights.

4.2 Product Variations

There are product variations above and beyond those that are field selectable by the end user(s). These variations are provided for the customer that has specialized needs. Here is a list of current ordering options for the Model FS19X/FS20X™:



FS19X-211-213

MultiBand IR plus UV Detector, General Applications with Relays, 4-20mA Output, FireBus II, Aluminum Enclosure with 3/4 inch NPT Conduit Entries, Class I, Zone 1, IR Self-Test, Approvals: FM, cFM, ATEX, IECEx

FS20X-211-222

MultiBand IR plus UV Detector, General Applications with Relays, 4-20mA Output, FireBus II, 316 Stainless Steel Enclosure with 3/4 inch NPT Conduit Entries, Class I, Divisions 1 & 2, Groups B, C & D, Class II, Groups E, F & G, Class III, Ex db IIC, Ex tb IIICIR and UV Self-Tests, Approvals: FM, cFM

4.3 Digital Communication Options

The FS19X/FS20X Detector has a variety of Analog and RS-485 Digital Communication options that can be selected using its Rotary Switch SW3.

SW3 Position	Outputs
0	4-20mA Current Sinking and FireBus II
1	4-20mA Current Sourcing and FireBus II
2	ModBus RTU and 4-20mA Current Sourcing
3	Reserved for Factory Use
4	FireBus II and 4-20mA Current Sourcing
5 through 9	Reserved for Factory Use

4.4 Test Lamps

Some manufacturers claim that their detectors do not need remote testing with an external Test Lamp because it tests itself. Even though Honeywell Analytics Detectors also perform “through the lens” self-testing and tests themselves, Honeywell Analytics, in compliance with NFPA 72 codes, has developed portable test lamps for periodical “end-to-end” testing their Detectors remotely. Some of the most important functions of the remote test lamp are to ensure the Detector’s optical path is not blocked, the Detector is aimed properly at the fire threat area (that the Detector mounting bracket didn’t move or was accidentally bumped by someone), and the Detectors alarming circuitry and outputs (i.e. relays, 4-to-20 mA, open collectors, etc.) function properly. Internal Detector testing and window lens cleanliness testing cannot insure the Detector is aimed properly, that its view of the fire scene has not been blocked by something such as a newly installed pipe or duct, storage box, parked vehicle, etc., and its alarm outputs are functioning properly.

For calibrated testing, in compliance with NFPA 72 Codes for flame detectors, as manufacturers of the FSX product line, our calibrated testing using our FT-2055X Test Lamp is as follows. If the FS19X/FS20X set at Highest Sensitivity alarms to a fully charged FT-2055X Test Lamp at a distance between 1 and 25 feet, then the FS19X/FS20X is in normal operating condition.

WARNING: Use test lamp model TL1055s in *non-hazardous* locations only! For hazardous locations, use models TL2055 or TL2145, as described below.

TL1055X is a general purpose NEMA 1 hand held rechargeable Test Lamp designed for testing the FSX™ Detectors externally. The hand held Test Lamp (see Figure 4-1) comes with a Universal Charger (110 VAC and 220 VAC).



Figure 4-1
TL1055X Hand Held Test Lamp (NEMA 1)

TL2055X is a Class I, Div. 1 approved Explosion-Proof Test Lamp designed for testing the FSX™ Detectors externally, in a hazardous location. The hand held Test Lamp (see Figure 4-2) comes with a Universal Charger (110 VAC and 220 VAC).



Figure 4-2
TL2055X Hand Held Test Lamp (Class I, Division 1)

4.5 Field of View Restrictor

There are some unique and specialized applications that may require a restricted field of view in order to prevent the Detector from alarming to a known (friendly) fire/flame source (such as a flare stack). The Model FVR-01 Field-of-View Restrictor is easily modified in the field with a simple hack saw to obtain custom Detector field-of-views for applications where specific narrow field-of-views are required. The Model FVR-01 Detector accessory has been developed specifically for these unique types of applications.

4.6 Additional Performance Specifications

4.6.1 Flame Response Sensitivity

The following table provides FS19X/FS20X typical indoor response times & distance to various fuels:

FS19X/FS20X MultiBand IR plus UV Detector			
Fuel	Fire Size	Distance	Typical Response
Acetylene	12 in (0.30 m) Plume - Medium Flame	35 ft (10.7 m)	2 Seconds
Acetylene	10 - 12 in (0.25 - 0.30 m) Plume - Lazy Flame	40 ft (12.2 m)	< 2 Seconds
Diesel	6 in X 6 in (15.2 cm X 15.2 cm)	87 ft (26.5 m)	< 3 Seconds
Ethanol	12 in X 12 in (0.3 m X 0.3 m)	50 ft (15.2 m)	< 3 Seconds
Hydrogen	3/8 in dia. (9.5 mm) orifice, 32 in (0.8 m) Plume	85 ft (25.9 m)	< 3 Seconds
IPA	6 in X 6 in (15.2 cm X 15.2 cm)	87 ft (26.5 m)	< 3 Seconds
JP4	6 in X 6 in (15.2 cm X 15.2 cm)	75 ft (22.9 m)	< 3 Seconds
JP8	6 in X 6 in (15.2 cm X 15.2 cm)	87 ft (26.5 m)	3 Seconds
Methane	3/8 in dia. (9.5 mm) orifice, 32 in (0.8 m) Plume	70 ft (21.3 m)	< 3 Seconds
Methanol	12 in X 12 in (0.3 m X 0.3 m)	40 ft (12.2 m)	< 3 Seconds
n-Heptane	6 in X 6 in (15.2 cm X 15.2 cm)	87 ft (26.5 m)	< 3 Seconds
Silane	1/32 dia (0.8 mm) orifice, 12 in (0.3 m) Plume	30 ft (9.1 m)	< 2 Seconds

The following table provides FS19X/FS20X typical outdoor response times & distance to various fuels:

FS19X/FS20X MultiBand IR plus UV Detector			
Fuel	Fire Size	Distance	Typical Response
Acetylene	12 - 16 in (0.30 - 0.41 m) Plume - Large Flame	100 ft (30.5 m)	< 3 Seconds
Acetylene	12 in (0.30 m) Plume - Medium Flame	100 ft (30.5 m)	< 4 Seconds
Acetylene	10 - 12 in (0.25 - 0.30 m) Plume - Lazy Flame	90 ft (27.4 m)	< 3 Seconds
Diesel	12 in X 12 in (0.3 m X 0.3 m)	150 ft (45.7 m)	4 Seconds
Ethanol	12 in X 12 in (0.3 m X 0.3 m)	60 ft (18.3 m)	< 3 Seconds
Hydrogen	3/8 in dia. (9.5 mm) orifice, 32 in (0.8 m) Plume	75 ft (22.9 m)	< 3 Seconds
IPA	12 in X 12 in (0.3 m X 0.3 m)	150 ft (45.7 m)	< 3 Seconds
JP4	12 in X 12 in (0.3 m X 0.3 m)	150 ft (45.7 m)	< 4 Seconds
JP8	12 in X 12 in (0.3 m X 0.3 m)	150 ft (45.7 m)	< 4 Seconds
Methane	3/8 in dia. (9.5 mm) orifice, 32 in (0.8 m) Plume	60 ft (18.3 m)	2 Seconds
Methanol	12 in X 12 in (0.3 m X 0.3 m)	40 ft (12.2 m)	< 2 Seconds
n-Heptane	12 in X 12 in (0.3 m X 0.3 m)	200 ft (61.0 m)	< 4 Seconds
Silane	1/32 dia (0.8 mm) orifice, 12 in (0.3 m) Plume	50 ft (15.2 m)	< 3 Seconds

4.6.2 High Temperature Response

The optional extended temperature range FS19X/FS20X Detector will respond to a one (1) square foot n-heptane reference fire at a distance of 35 feet in 2 to 5 seconds, when the temperature exceeds 85°C.

Additional Performance Specifications *(continued)*

4.6.3 False Alarm Immunity

The following tables represent the minimum distance at which the Detector did not false alarm or show any signs of instability during exposure to the sources listed below. Additionally, the sensitivity to a one (1) square foot n-Heptane reference pan fire in the presence of the false fire source is listed.

False Fire Source	Minimum Distance with no Alarm	Sensitivity to a 1' x 1' n-Heptane reference pan fire in the presence of the false fire source
Direct Sunlight	No Alarm	50 feet / 15.24 meters
Modulated Sunlight	No Alarm	25 feet / 7.62 meters
Modulated Arcwelding	9 feet 9 inches / 3 meters	Source at 30 feet / 9.14 meters Fire at 30 feet / 9.14 meters
Continuous Arcwelding	9 feet 9 inches / 3 meters	Source at 30 feet / 9.14 meters Fire at 30 feet / 9.14 meters
Resistive Electric Heater	1 foot / 30.48 centimeters	Source at 3 feet / 91.44 centimeters Fire at 200 feet / 60.96 meters
Flourescent Lamp	1 foot / 30.48 centimeters	Source at 3 feet / 91.44 centimeters Fire at 200 feet / 60.96 meters
Halogen Lamp	1 foot / 30.48 centimeters	Source at 3 feet / 91.44 centimeters Fire at 200 feet / 60.96 meters
Sodium Vapor Lamp	1 foot / 30.48 centimeters	Source at 3 feet / 91.44 centimeters Fire at 200 feet / 60.96 meters
Pelican Flashlight	1 foot / 30.48 centimeters	Source at 3 feet / 91.44 centimeters Fire at 200 feet / 60.96 meters
Incandescent Lamp	1 foot / 30.48 centimeters	Source at 3 feet / 91.44 centimeters Fire at 200 feet / 60.96 meters

4.7 Drawings

4.7.1 Outline and Dimensions

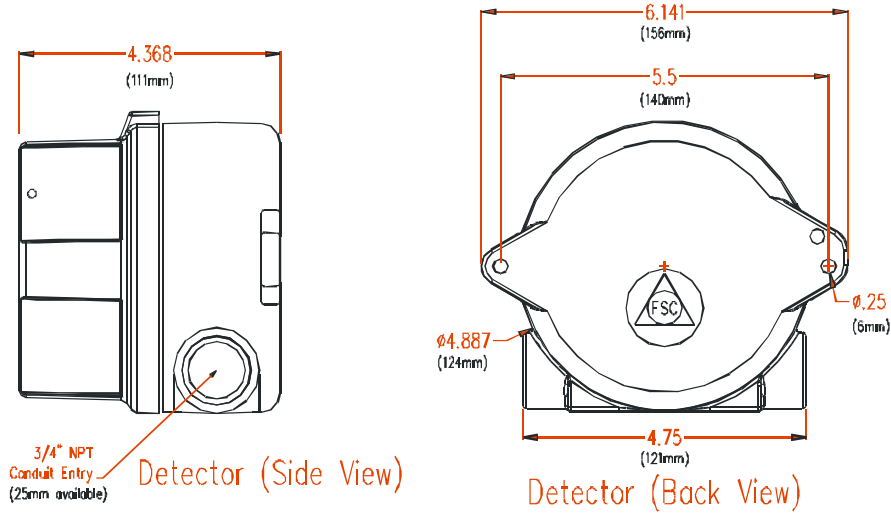


Figure 4-3
Outline & Dimensional Drawing for FS19X/FS20X

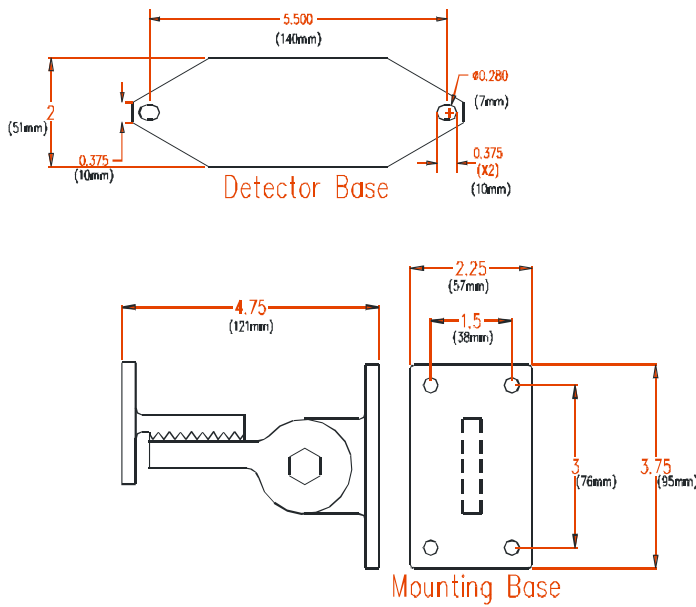


Figure 4-4
Outline & Dimensional Drawing for SM4

Drawings (continued)

4.7.2 Wiring and Terminal Connections

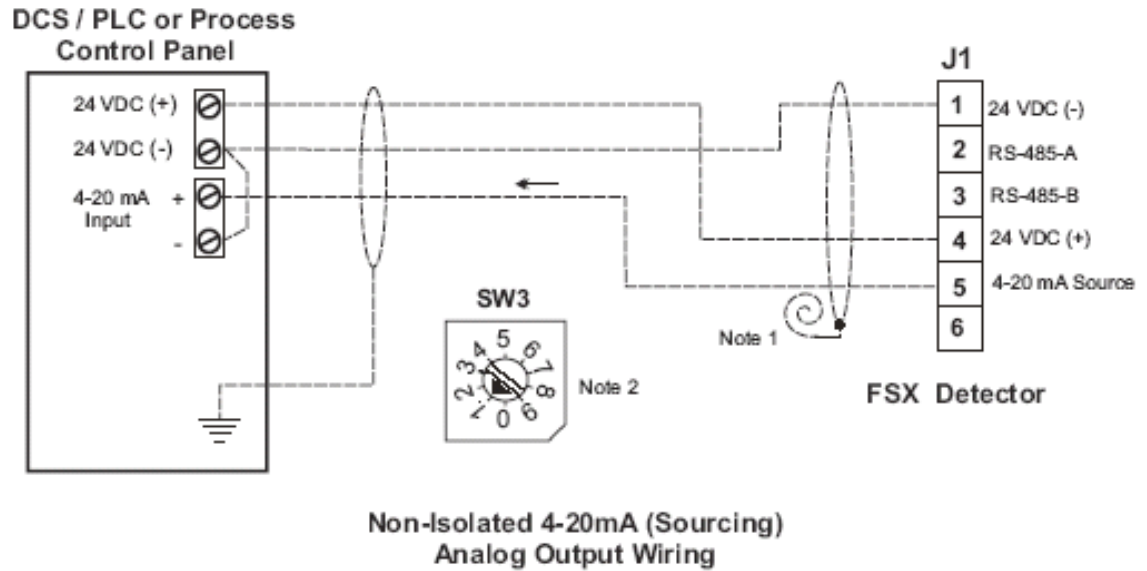


Figure 4-5
Typical Wiring for 4-20mA (Sourcing) Analog Output

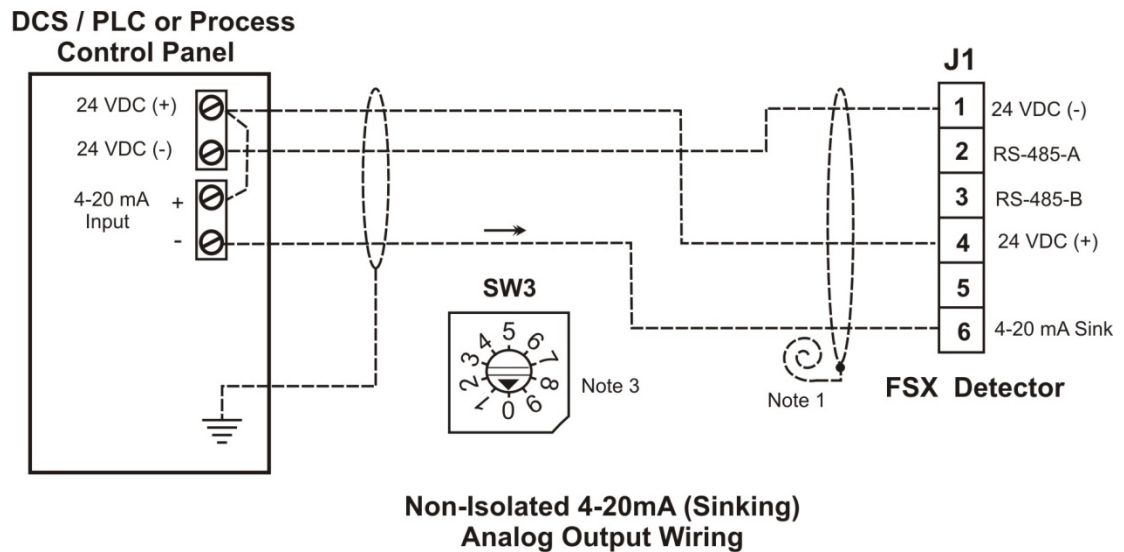


Figure 4-6
Typical Wiring for 4-20mA (Sinking) Analog Output

NOTES:

1. Cable shield must be grounded at one end only, at the Control Panel. Coil and tape cable shield at the Detector end.
2. Set SW3 (rotary switch) to position one (1) for Source current wiring.
3. Set SW3 (rotary switch) to position zero (0) for Sink current wiring.

Drawings (continued)

Wiring and Terminal Connections (continued)

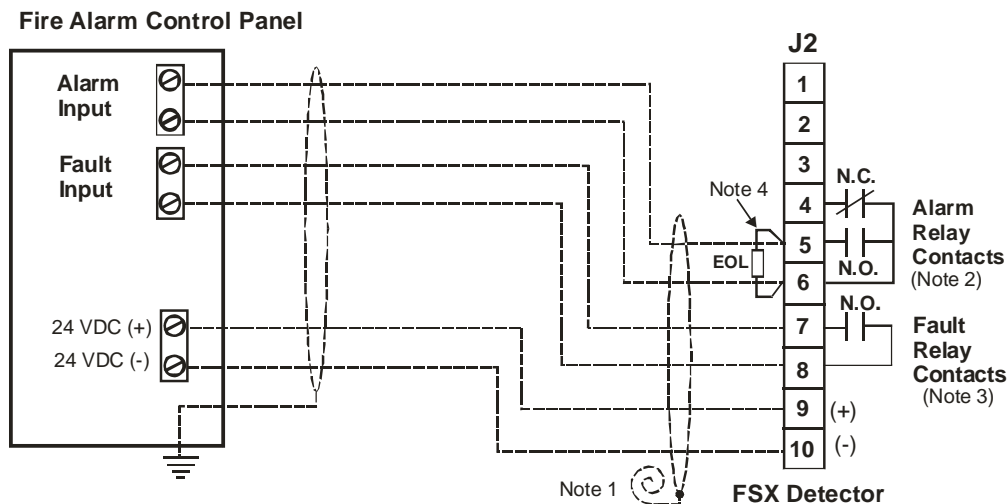


Figure 4-7

Typical Relay Output Wiring for Monitoring Separate Alarm and Fault Contacts

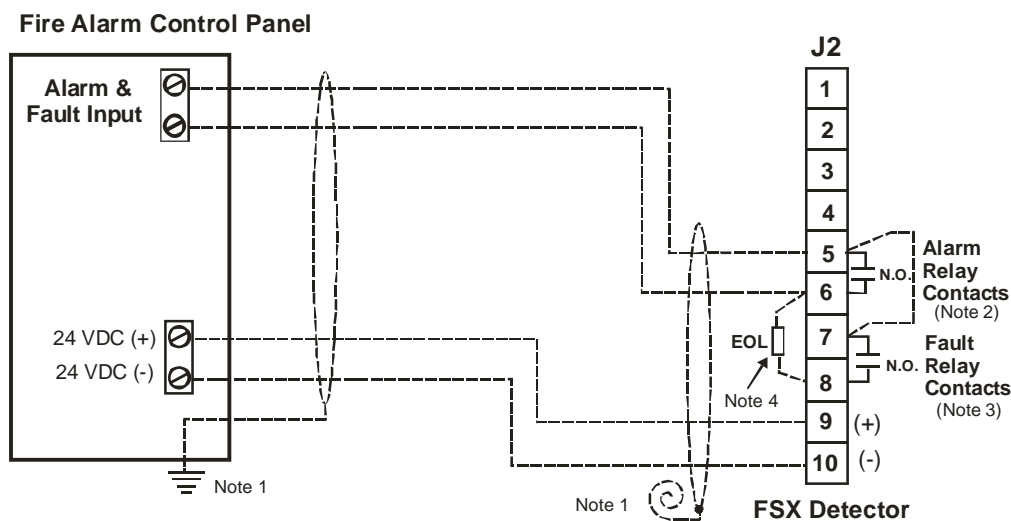


Figure 4-8


Typical Relay Output Wiring for Monitoring Alarm and Fault Contacts on a single two-wire input


NOTES:

1. Cable shield must be grounded to "Earth Ground" at the Control Panel end only. Coil and tape the cable shield at the Detector end.
2. Alarm relay contacts shown with no power applied. Alarm relay is normally De-Energized during normal operation and with no Alarm. This relay will Energize during Alarm conditions.
3. Fault relay contacts shown with no power applied. During normal operation and with no Fault, this relay will De-Energize and the N.O. (normally open) contacts will close.
4. EOL (End-Of-Line) device shall be installed as required and supplied by the Fire Alarm Panel.


Drawings (continued)


Detector Label Drawings







LB-6093- **CAUTION: OPEN CIRCUIT BEFORE REMOVING COVER.**
ATTENTION: OUVRIR LE CIRCUIT AVANT D'ENLEVER LE COUVERCLE.

Honeywell Model 




Assembled in USA
 Honeywell Analytics Inc.
 405 Barclay Blvd.
 Lincolnshire, IL 60069


MFG DATE: 


Electrical (Max): 32VDC, mA
 Relay Contact Rating: 24VDC, 1A
**DO NOT OPEN WHEN A
 FLAMMABLE ATMOSPHERE IS
 PRESENT. SEAL CONDUIT
 WITHIN 450mm OF ENCLOSURE**

Class I Div 1, Groups ABCD;
 Class II/III, Div 1, Groups EFG;
 Class I, Zone 1, AEx d IIC;
 T4: Ta = °C to +°C
 T5: Ta = °C to +°C
 T6: Ta = °C to +°C
 Type 4X, IP66


Ex d IIC T6...T4 Gb
 Ex tb IIIC T135°C Db IP66
 IECEX FMG 14.0027X
 II 2 G Ex d IIC T6...T4 Gb
 II 2 D Ex tb IIIC T135°C Db IP66
 FM14ATEX0058X

LB-6093- **WARNING**
DO NOT OPEN IN HAZARDOUS AREA

Honeywell Model  Test Lamp




Assembled in USA
 Honeywell Analytics Inc.
 405 Barclay Blvd.
 Lincolnshire, IL 60069

MFG DATE: 

Electrical (Max): 15VDC, @1.0A
 Class I Div 1, Groups BCD, T4 Ta = -30°C to 85°C; Type 4X, IP66
 Class II/III Div 1, Groups EFG; T3 Ta = -30°C to 85°C; Type 4X, IP66
 Class I, Zone 1, AEx d IIB+H2; T4 Ta = -30°C to 85°C; Type 4X, IP66

Ex d IIB+H2 T4 Gb IP66
 IECEX FMG 14.0025
 II 2 G Ex d IIB+H2 T4 Gb IP66
 FM14ATEX0057

Ta = -30°C to +85°C

Part Number	Model Number	Material	Background Color	Text Color	mA	T4	T5	T6
LB-6093-041	FS19X	0.020' Al 1100-HI4	Black	White	150	-40C to +110C	-40C to +75C	-40C to +60C
LB-6093-042	FS19X	0.020' 316 Stainless Steel	Polished	Black	150	-40C to +110C	-40C to +75C	-40C to +60C
LB-6093-043	FS19X	0.020' Al 1100-HI4	Black	White	150	-40C to +110C	-40C to +75C	-40C to +60C
LB-6093-044	FS19X	0.020' 316 Stainless Steel	Polished	Black	150	-40C to +110C	-40C to +75C	-40C to +60C
LB-6093-037	FS20X	0.020' Al 1100-HI4	Black	White	150	-40C to +110C	-40C to +75C	-40C to +60C
LB-6093-038	FS20X	0.020' 316 Stainless Steel	Polished	Black	150	-40C to +110C	-40C to +75C	-40C to +60C
LB-6093-039	FS20X	0.020' Al 1100-HI4	Black	White	150	-40C to +110C	-40C to +75C	-40C to +60C
LB-6093-040	FS20X	0.020' 316 Stainless Steel	Polished	Black	150	-40C to +110C	-40C to +75C	-40C to +60C

INDEX

A

Alarm Condition, 14
Alarm LED, 11
Alarm Relay, 11, 14
Applications, 5
Auxiliary Relay, 14

C

CAUTION, 7
cleaning, 7, 15
Communications, 4
conduit plug, 9
conduit seal, 9
Configuring the Detector, 12, 13
connector, 2, 9

D

Demo Mode, 13
Detector Connections, 8
Detector Puck, 8
Digital Communication Options, 18
DIP switch, 2

E

Explosion-Proof, 18

F

Fault Conditions, 15
Fault Relay, 9, 15
Features and Benefits, 3, 4
Fire, ii
FireBus I, 13, 15
FireBus II, 13, 14

G

Green LED, 14

H

Hazardous Locations, 2

I

Installation Practices, 9, 11

L

LED Status Indicators, 14

M

Maintenance, 15
Microprocessor Watchdog, 15
ModBus, 4, 13, 14, 15
Module, 7
Mounting Instructions, 6, 7
Multi-Spectrum, 2, 12

N

Normal Operation, 14

O

Opening the Detector, 7

P

Principle of Operation, 12
Product Overview, 2
Product Variations, 17

R

radiant energy, 2, 12
Red LED, 14
Relay Coil, 15
Relay Options, 2, 4

S

Self Test, 4
Sensitivity, 2, 4
Start-Up and Commissioning, 10

T

Temperature, 4, 15
Test Lamp, 11, 15, 18
Trouble, 15

W

Warranty Information, 16
weather-proof, 9

Y

Yellow LED, 14, 15

CONTACT HONEYWELL ANALYTICS

Americas

Honeywell Analytics Inc.
 405 Barclay Blvd.
 Lincolnshire, Illinois
 USA 60069
 Email: detectgas@honeywell.com

Europe

Life Safety Distribution AG
 Javastrasse 2
 8604 Hegnau
 Switzerland
 Email: gasdetection@honeywell.com

Asia Pacific

Honeywell Analytics Asia Pacific Co., Ltd.
 #701 Kolon Science Valley (1)
 43 Digital-Ro 34-Gil, Guro-Gu
 Seoul, 152-729
 Korea
 Email: analytics.ap@honeywell.com

Internet

These Honeywell websites may be of interest to Industry Solution customers.

Honeywell Organization	URL
Corporate	www.honeywell.com
Honeywell Analytics	www.honeywellanalytics.com

Telephone

Contact us by telephone at these numbers.

Organization	Phone Number
Americas Honeywell Analytics Inc.	1-800-538-0363 1-800-321-6320
Europe Life Safety Distribution AG	{32-2} 728-2711
Asia Pacific Honeywell Analytics Asia Pacific Co., Ltd.	+82 2 6909 0321 VOIP: +8 5401 0321



MICROWATT
Making Safety Work

Tollfree in Western Canada: 1-888-388-1592
microwatt.com • mwsales@microwatt.com

SALES • SERVICE • SUPPORT

Honeywell

1998M0902

Rev. A

July, 2014

© 2014 Honeywell International Inc.