

## Safety

### **WARNING**

Read and understand contents of this manual prior to operation.  
Failure to do so could result in serious injury or death.

### IMPORTANT SAFETY

The following terms and symbols are used in this manual to alert the operator of important instrument operating issues:

 This symbol is intended to alert the user to the presence of important operating and maintenance (servicing) instructions.

 This symbol is intended to alert the user to the presence of dangerous voltage within the instrument enclosure that may be of sufficient magnitude to constitute a risk of electric shock.

 This symbol signifies the system's ground terminal

**DC** refers to direct current voltages.

**VAC** refers to alternating voltages.

### **WARNINGS**

- **Shock Hazard - Disconnect or turn off power before servicing this instrument.**
- **NEMA 4X wall mount models should be fitted with a locking mechanism after installation to prevent access to high voltages by unauthorized personnel (see [Figure 4-1](#)).**
- **Only the combustible monitor portions of this instrument have been assessed by CSA for 122.2 No. 152 performance requirements (for**

combustibles using mA input.

- This equipment is suitable for use in Class I, Division 2, Groups A,B,C and D or non-hazardous locations only.
- **EXPLOSION HAZARD- SUBSTITUTION OF COMPONENTS MAY IMPAIR SUITABILITY FOR CLASS I, DIVISION 2.**
- **EXPLOSION HAZARD- DO NOT REPLACE FUSE UNLESS POWER HAS BEEN SWITCHED OFF OR THE AREA IS KNOWN TO BE NON-HAZARDOUS.**
- **EXPLOSION HAZARD- DO NOT DISCONNECT EQUIPMENT UNLESS POWER HAS BEEN SWITCHED OFF OR THE AREA IS KNOWN TO BE NON-HAZARDOUS.**

### **CAUTIONS**

- Use a properly rated **CERTIFIED AC power (mains) cable** installed as per local or national codes.
- For DC powered units, DC power must be from a SELV rated source.
- A certified AC power (mains) disconnect or circuit breaker should be mounted near the controller and installed according applicable local and national codes. If a switch is used instead of a circuit breaker, a properly rated CERTIFIED fuse or current limiter is required to be installed as per local or national codes. Markings for positions of the switch or breaker should state (I) for on and (O) for off.
- Clean using only a damp cloth with no solvents.
- Equipment not used as prescribed within this manual may impair overall safety

## Table of Contents

<b>Safety</b> .....	<b>i</b>
<b>1 General Description</b>	
<b>1 General Description</b> .....	<b>1-2</b>
<b>1.1 Data Display Screens</b> .....	<b>1-3</b>
1.1.1 Main Data Screen .....	1-3
1.1.2 Trend Screen .....	1-3
1.1.3 Blind Mode Screen.....	1-3
<b>1.3 Specifications</b> .....	<b>1-3</b>
1.3.1 Power Supply Requirements.....	1-3
 Warning.....	1-4
1.3.2 Relays .....	1-4
1.3.3 Ambient Temperature Range .....	1-4
1.3.4 Humidity Range .....	1-4
1.3.5 Altitude .....	1-4
1.3.6 Housings / Installation Categories .....	1-5
1.3.7 Approvals .....	1-5
<b>2 Operation</b>	
<b>2 Operation</b> .....	<b>2-2</b>
<b>2.1 Setup Menu Configuration</b> .....	<b>2-2</b>
<b>2.2 Changing Menu Variables Using The Keypad</b> .....	<b>2-3</b>
2.2.1 Setup Configuration Menus .....	2-3
2.2.2 Channel Setup Entry Menu.....	2-3
2.2.3 Alarm 1 / Alarm 2 / Alarm 3 Set-Up Menus.....	2-3
2.2.4 Using the Configure Menu to Define Channel .....	2-4
Name / Eunits ASCII Data Fields .....	2-4

---

Input Measurement Range.....	2-5
Decimal Point Resolution .....	2-5
Turning Off Unused Channels.....	2-5
2.2.5 CAL Setup Menu.....	2-5
2.2.6 Calibrate Input Menu.....	2-6
<b>2.3 System Configuration Menus .....</b>	<b>2-7</b>
2.3.1 Relay 1 / Relay 2 Menus .....	2-7
2.3.2 Horn / Piezo Menu .....	2-8
2.3.3 Comm Port Menu.....	2-8
2.3.4 Clock / Delays Menu .....	2-9
2.3.5 Diagnostics Menu .....	2-9
<b>2.4 System Security Menu.....</b>	<b>2-10</b>
<b>3 Motherboard Interface PCB</b>	
<b>3 Motherboard Interface PCB .....</b>	<b>3-2</b>
<b>3.1 Input / Output Optional PCB's .....</b>	<b>3-3</b>
3.1.1 Optional Analog Input PCB .....	3-3
3.1.2 Optional Discrete Relay PCB's.....	3-4
3.1.3 Optional 4-20mA Analog Output Board .....	3-5
<b>3.2 Modbus RS-232 / RS-485 Interface Option .....</b>	<b>3-6</b>
3.2.1 Modbus Register And Function Code Summary.....	3-7
<b>4 Enclosures</b>	
<b>4 Enclosures .....</b>	<b>4-2</b>
4.1 HA20PCS/HA20SS NEMA Steel Enclosures.....	4-2
4.2 HA20PY NEMA Polycarbonate Enclosure .....	4-2
4.3 HA20XP NEMA 7 Explosion-Proof Wall Mount Enclosure.....	4-3
<b>5 Parts List</b>	
<b>5 Parts List .....</b>	<b>5-2</b>
<b>6 Specifications</b>	

---

[5 Specifications](#) .....6-2

[7 Warranty](#)

[Honeywell Analytics Warranty Statement](#).....7-2



---

# **1 General Description**

---

## 1 General Description

The Honeywell Analytics HA20 2-Channel Controller is designed to display, and control alarm event switching for two inputs. Inputs are typically voltage or 4-20mA current from transmitters, monitors or other analog output devices. The HA20 is equipped with a Fault and three alarm levels per channel with features such as ON / OFF delays, latching relays and alarm Acknowledge. A dedicated horn driver circuit for a local audible annunciator is also standard. Two standard 5-amp alarm relays are configurable via the “alarm voting” menu to make relays trip based on various alarm combinations. A real-Time Clock and Calendar are also standard. Options such as 4-20mA outputs, discrete relays for each alarm and audible annunciators are easily added. RS-485 (Modbus RTU) ports are also available for sending data to PC’s, PLC’s, DCS’s, or other Honeywell Analytics controllers.

A 128 x 64 pixel graphic LCD readout displays monitored data as bar graphs, 30-minute trends and engineering units. System configuration is via user friendly menus and all configuration data is retained in non-volatile memory during power interruptions. The HA20 front panel shown in Figure 1-1 displays the bar graph data screen. The five button symbols below the display are magnetically activated using the magnetic wand (supplied) without opening the enclosure. Opening the enclosure door provides access to the “touch” keypad as shown in Figure 1-2.

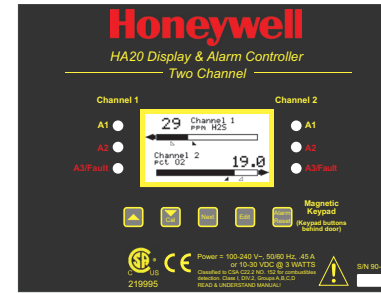

Figure 1-1. Front Panel

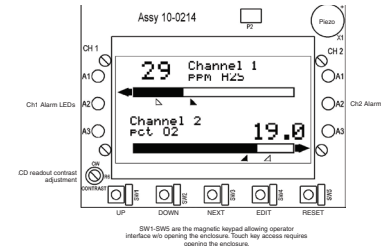

Figure 1-2. Front Panel Display (open enclosure)



## 1.1 Data Display Screens

The HA20 Controller offers three modes for displaying monitored data, as shown in Figure 1-3.

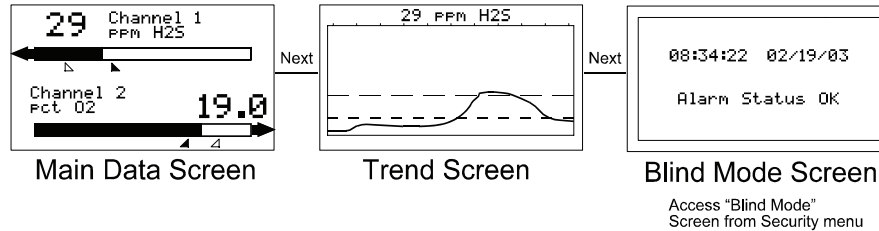

Figure 1-3. Data Display Screens

### 1.1.1 Main Data Screen

The HA20 Main Data screen shown in Figure 1-3 allows each channel to be viewed simultaneously. Engineering unit values and bar graph values are both displayed in real time. Arrows below the bars indicate alarm trip point values, making it easy to identify channels at or near alarm level. The direction the horizontal 45° side arrow points indicates either a HIGH or LOW trip point. In [Figure 1-1](#) where Ch 1 points right indicating high trip levels and Ch 2 points left indicating low trip levels. Left and Right hand arrows located at the ends of each bar graph point towards Channel Alarm LED's on the front panel associated with this reading. The 10-digit ASCII fields for identifying engineering units and Channel ID for each channel are also shown on the Main Data screen.

### 1.1.2 Trend Screen

In addition to the Main Data screen described above, the HA20 also provides 30-minute trend screens for each channel as shown in Figure 1-3. Use the Next key to scroll between data screens.

### 1.1.3 Blind Mode Screen

The HA20 Blind Mode screen (Figure 1-3) does not allow viewing of channel engineering unit values. It only indicates the system's alarm status and time / date. Some applications require only alarm status be displayed and prefer monitored values not be shown. A SECURITY menu (see [Section 2.4](#)) allows locking all configuration parameters and having only the Blind Mode screen available for viewing.

## 1.3 Specifications

### 1.3.1 Power Supply Requirements

The HA20 is equipped with an integral 15 watt (or 50 watt, depending on the configuration) universal AC input / 24 VDC output switching power supply. Standard HA20 AC power requirements are 100-240 VAC 50/60 Hz @ .45 amp max (including inrush) and 20 watts steady state, applied to TB5 on the motherboard. If AC power is not available, the HA20 may also be powered with 24 VDC applied to TB1 on the motherboard. A primary DC source or back-up DC source capability should be determined by the total system power budget calculation with guard-band included. A back-up DC power source may also be connected to TB1 for automatic switchover if the AC power source fails. See [Figures 3-1 & 3-2](#) for wiring information.

### WARNING

**A back-up or external DC power source DOES NOT source aux power output (TB3 - see [Figure 3.1](#))**

The basic HA20 consumes only 1.5 watts of 10-30 VDC from the integral power supply.

Optional features, and external devices such as remote transmitters, increase power consumption as described below:

- Discrete Relay PCB option; add 1.5 watt.
- 4-20mA Output PCB option; add .5 watt.
- TB3 terminals 1 & 2 on the motherboard provide a maximum of 350mA output power for powering of auxiliary external devices such as relays, lamps or transmitters (see [Figure 3-1](#)). Power consumed from these terminals must be included when calculating system power consumption.
- 10-0221-2, Analog Input PCB option; add wattage for each monitor connected to this board's 24 VDC terminal

Some applications require the HA20 controller to source power for high power monitors. Both 15 watt and 50 watt power supplies, UL rated for Div 2 hazardous areas, are available. This option is also available with a Div 1 enclosure if an explosion-proof enclosure is required. (See [Section 5 - Specifications](#).)



## **WARNING**

**A backup, or external DC power source DOES NOT source auxiliary power output (see figure 3.1 TB3).**

## **1.3.2 Relays**

Two mechanical (dry contact) Common Form C relays are standard and may be mapped to various alarm events as described in [Section 2.3.1](#). HA20's may also be equipped with optional solid-state common Form A relays (see [Section 5 - Specifications](#) for details) in applications requiring non-arcing switching. Solid-state relays are recommended for switching of highly inductive loads.

A six mechanical (dry contact) Discrete Relay option board (see [Section 3.1.6](#)) provides dedicated Form C relays for ALARM 1, ALARM 2 and FAULT for all channels.



## **WARNING**

**All mechanical (dry contact) relays are rated at 5 Amp for 28 VDC and 250 ~VAC RESISTIVE loads. IMPORTANT: Appropriate diode (DC loads) or MOV (AC loads) snubber devices must be installed with inductive loads to prevent RFI noise spikes.**

Optional solid state relays are rated at 2 Amp 12-280~VAC (600Vpk).

Relay wiring should be kept separate from low level signal wiring.

## **1.3.3 Ambient Temperature Range**

-25 to 50 degrees C

## **1.3.4 Humidity Range**

0 to 90% R. H. Non-Condensing.

## **1.3.5 Altitude**

Recommended up to 2000 meters

## 1.3.6 Housings / Installation Categories

- \*NEMA 4X wall mount. DIV 2 Groups A,B,C,D; Category II and pollution degree 3; NEMA 4X; IP66
- \*NEMA 4 painted carbon steel
- SS316 NEMA4X
- Polycarbonate NEMA4X
- \*NEMA 7 wall mount for DIV 1 & 2 Groups B,C,D; includes O-ring in door to satisfy NEMA 4 rating.

\*Includes standard non-intrusive magnetic keypad.

## 1.3.7 Approvals

- CSA C22.2 No 1010.1 and ISA S82.02
- CSA C22.2 No 152 for combustibles (**mA input only**)
- UL 1604 / C22.2 No 213 (Div 2 Groups A,B,C,D)
- EN55011 & EN61000 (CE Mark). CSA File # = 219995 and may be seen at: [www.CSA-International.org](http://www.CSA-International.org).

---

**2 Operation**

---

## 2 Operation

The HA20's graphic LCD displays monitored data. The 5-button keypad and the display serve as the system's operator interface. All configuration variables are entered using this operator interface through SETUP menus accessed by pressing **Edit** from either data screen. This Setup mode may be exited manually by pressing **Next**, or automatically when no keys are pressed for 5 minutes. Alarm relays and front panel alarm LED indicators remain active during the Setup mode. Alarm LED's flash upon new alarms and become steady after Acknowledged by pressing the **Alarm Reset** key. A SECURITY menu offers a password feature to prevent tampering with HA20 parameters.

A "sign-on" screen appears briefly after power is applied that indicates what type of input / output options are configured with the unit.

Several signal conditioning input options are available to allow the HA20 to accept sensor and other analog signals directly (see [Section 3.1](#)).

### 2.1 Setup Menu Configuration

Variables within the CHANNEL (see [Section 2.2](#)) and SYSTEM (see [Section 2.3](#)) menu trees allow HA20 configuration of a wide range of monitoring applications. Select the desired menu by scrolling with Up/down arrows and then Edit to enter each menu. Figure 2-1 illustrates the menu tree configuration with Channel variables on the left and System variables on the right. Channel variables affect only the specific channel selected while System variables are related to features not specific to either channel.

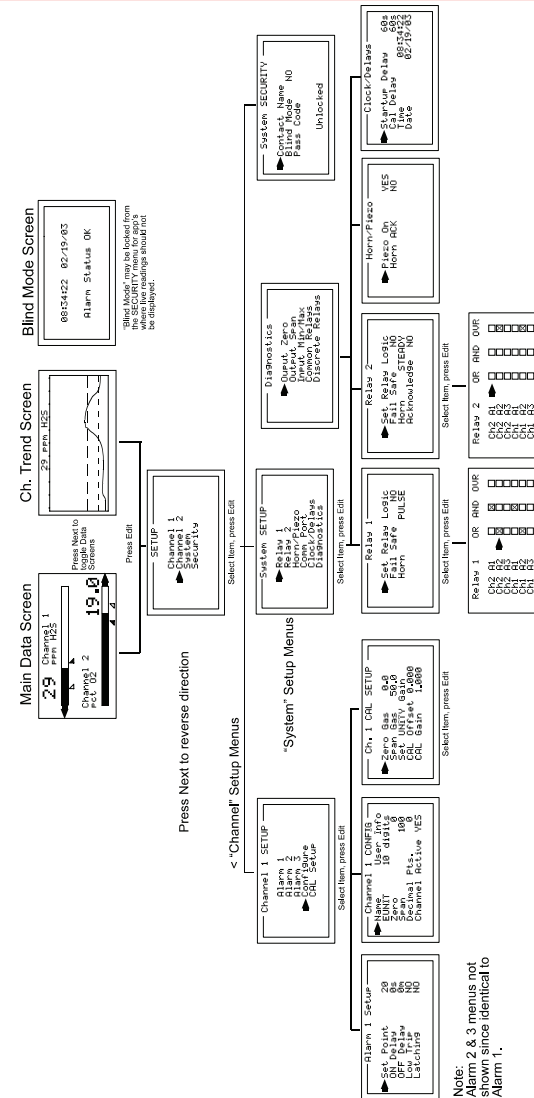

HA20 Dual Channel Controller Menu Tree

Note:  
Alarm 2 & 3 menus not shown since identical to Alarm 1.

Figure 2-1. Menu Tree

## 2.2 Changing Menu Variables Using The Keypad



Figure 2-1. Keypad

Upon entering a menu, a pointer controlled by the up/down arrow keys, indicates the selected variable. Some are simple YES/NO or ON/OFF entries toggled by pressing the Edit key. Others, such as Channel ID and Eunits fields, may have many ASCII character possibilities. Allowed ASCII characters are as follows:

```

ABCDEFGHIJKLMNPOQRSTUVWXYZ
abcdefghijklmnopqrstuvwxy
blank space
!"#$%&()*+,-./0123456789:;<=>?@[^\`_.
```

Notice the often used blank character is located after lower case z and before the exclamation point !. Edit places a cursor under the item and up/down arrow scroll through each allowed entry. The Next key moves the cursor to the next position within a field. When the field is complete, Edit clears the cursor and loads the field into non-volatile memory where it is retained indefinitely. Without a cursor present, the Next key closes open menus in reverse order and returns the LCD to the data display.

### 2.2.1 Setup Configuration Menus

The SETUP menu shown in the middle of [Figure 2-1](#) and in [Figure 2-2](#) is reached by pressing Edit with any data display present. This is the entry-level screen to **all** Channel, System and Security menus. It also shows the firmware version operating in the HA20. Use the up/down arrows keys to move the pointer to the desired menu and press the Edit key to select.

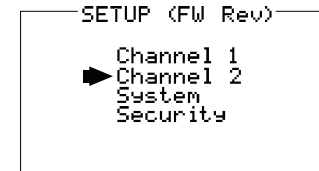

Figure 2-2. Setup Configuration Menu

### 2.2.2 Channel Setup Entry Menu

The **Channel x SETUP** menu shown in [Figure 2-3](#) allows configuration of all variables for the selected channel. These are Alarm 1, Alarm 2, Alarm 3, Configure and CAL Setup.

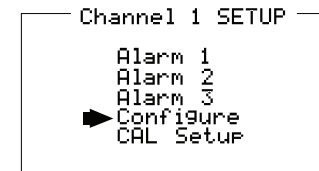

Figure 2-3. Channel Setup Entry Menu

### 2.2.3 Alarm 1 / Alarm 2 / Alarm 3 Set-Up Menus

**Alarm 1, 2 and 3** have identical menus. The only difference is that A1 LED indicators are yellow while A2's and A3's are red. Typical applications often have A1 set at a WARN level, A2 at a HIGH level and A3 at a negative FAULT level. However, it is important to understand there is no functional difference between A1, A2 and A3, therefore only one is shown in [Figure 2.4](#).

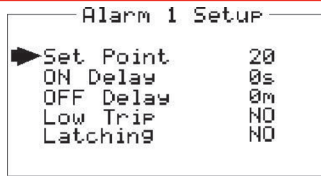

Figure 2-4. Alarm Setup Menu

- Set Point is entered in engineering units and determines the value at which the alarm trips. For example, if a channel monitors 0-50 ppm H<sub>2</sub>S and the desired alarm level is 10 ppm, the correct entry is 10.00. A one percent deadband prevents alarm chatter. This means after tripping an alarm the input must move at least 1% of full scale back through the setpoint for the alarm to auto reset.
- The ON Delay / OFF Delay entries allow ON and OFF time delays affecting how long the trip-point must be surpassed before an alarm event transition occurs. ON delays are limited to 10 seconds while OFF delays may be as long as 120 minutes. Delays are useful in many applications to prevent nuisance alarms and unwanted cycling into and out of alarm conditions.
- Low Trip is set to NO to increase alarms or YES to decrease alarms, which determines if the alarm activates upon exceeding or falling below the set-point.
- Latching determines either manual or automatic alarm reset operation. YES requires a manual Alarm Reset to unlatch the alarm even though an alarm condition no longer exists. YES also causes this alarm's common relay, front panel LED, and optional discrete relay to latch. NO allows all outputs for this alarm to automatically reset after the alarm condition clears.

Discrete LED indicators on the front panel indicate the status of each

alarm. Any new alarm event causes the associated LED to flash until an Alarm Reset occurs causing an acknowledged steady on condition. Operators should recognize new alarms by a flashing LED. Alarm Reset also acknowledges, or deactivates, audible devices driven by the AUDIBLE ALARM option connector J2 (see [Figure 3.2](#))

## 2.2.4 Using the Configure Menu to Define Channel

The next menu option, after the Alarm Setup option, is **Configure**. It allows setting Name and EUNIT fields, defining the measurement range (Zero and Span), how many decimal points of resolution the reading will have and whether the channel is active (Figure 2.5).

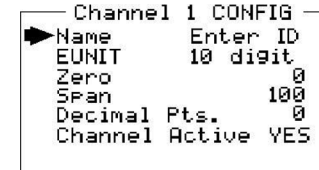

Figure 2-5. Configure Menu - Define Channel

### Name / Eunits ASCII Data Fields

The first two items in this menu, **Name** and **EUNIT**, are for entering the 10 character channel Name and engineering unit ASCII fields. Name should describe the channel's data in user terminology such as tag # or other description. Eunits should define the units of measure for what this channel is to display. Several standard Eunits fields are available by pressing **Edit** but if these are inappropriate, a CUSTOM field allows editing of each character. Section 2.2 describes how to modify these fields using the keypad.

## Input Measurement Range

The **ZERO** / **SPAN** menu options allow configuration of the measurement range displayed by this channel. Measurement Range defines the range of the input signal's engineering units. For example, if a channel's input is 4-20mA from a transmitter monitoring 0 to 10ppm chlorine, then the Zero value should equal 0.000 and the Span value equal 10.00. Four digits must be entered so trailing 0's may appear here that are not displayed on other data screens.

## Decimal Point Resolution

Resolution of the displayed channel value is configured in the **Decimal Pts.** menu by setting the number of digits trailing the decimal point. Displayed readings are limited to a maximum of four digits with a polarity sign. Auto-ranging displays the highest resolution allowed by this menu's decimal point entry. For example, a range of 0 to 100ppm and two decimal points reads 0.00 at 0ppm and 100.0 at 100ppm. This may be undesirable due to the high resolution at zero unless the sensor's output is extremely stable. If decimal points are limited to one, the 0ppm reading becomes 0.0 and the 100ppm reading remains 100.0.

Resolution may be limited further by setting decimal points to 0 where in the above example, 0ppm reads 0 and 100ppm reads 100.

## Turning Off Unused Channels

The **Channel Active** menu entry asks if this channel is to be utilized. OFF causes the controller to never process inputs applied to this channel and no alarms are tripped or data displayed. Inactive channels have a line drawn through them on the Setup screen to indicate they are turned off.

## 2.2.5 CAL Setup Menu

The CAL SETUP feature supports pushbutton calibration of zero and span values. This feature should only be utilized when there are no other zero/span controls within the monitoring system since it is inappropriate to calibrate a signal at more than one point.

Therefore, if calibration will be performed at another transmitter or monitoring device, the CAL MODE feature should not be used.

The **CAL SETUP** menu allows entering the correct Zero Gas & Span Gas set-point values needed to calibrate the sensor. These are entered in the same engineering units as the input range.

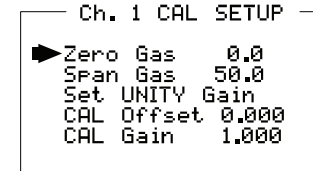

Figure 2-6. Cal Setup Menu



## 2.2.6 Calibrate Input Menu

Calibration is the most important function for ensuring correct operation of HA20s equipped with sensor inputs. The CAL MODE (flow chart shown in [Figure 2-7](#)) is designed to make calibration quick, easy and error free. A successful ZERO and SPAN calibration requires only five keystrokes. Optional 4-20mA outputs (if equipped) transmit 1.5mA during CAL MODE and 4mA during the subsequent CAL PURGE delay to prevent external alarms during calibration. Local HA20 alarm relays are inhibited during CAL MODE. Unintentional calibrations may be reset using the Set UNITY menu item. Set UNITY resets CAL OFFSET to 0 & CAL GAIN to 1 which is useful for returning the calibration to a known starting place. Sensor aging may be monitored by recording zero and span readings at Unity Gain when the sensor is new, and again later when degradation may have occurred. CAL MODE automatically exits if no keystroke is detected after 5 minutes.

Follow these sensor calibration guidelines:

- Calibration accuracy is only as good as the calibration standard accuracy. Honeywell Analytics recommends calibration standards with NIST (National Institute of Standards and Technology) traceable accuracy to increase the validity of the calibration.
- Do not use a gas cylinder beyond its expiration date.
- Calibrate a new sensor before use.
- Allow the sensor to stabilize before starting calibration. (Consult the appropriate sensor manual for warm-up times.)
- Calibrate on a regular schedule. (Consult the appropriate sensor manual for calibration intervals or depending on use and sensor exposure to poisons and contaminants.)
- Calibrate only in a clean atmosphere free of background gas.

Use the following step-by-step procedure to perform ZERO and SPAN calibrations.

1. To enter the CAL MODE from any data display, press the dual purpose down arrow/CAL key and press the Edit key within 5 seconds then select channel.
2. Using the Cal-Cup and following the instructions on the screen, apply a clean ZERO gas or be sure there is no background target gas in the monitored area. After the reading is stable, (approximately 1 minute) press the Edit key to perform a ZERO calibration.
3. If the ZERO calibration is successful, CAL MODE automatically proceeds to the SPAN check.
4. Apply the correct SPAN calibration standard. After the reading is stable, press the Edit key to perform a SPAN calibration.

### **WARNING**

**The SPAN gas used must match the value specified since this is what the HA20 will indicate after a successful SPAN calibration. The Span Gas value may be edited if it becomes necessary to apply a different gas concentration (see Figure 2.6 [Span Gas] in [Section 2.2.5](#)).**

5. If the SPAN calibration is successful, the display flashes “REMOVE CAL GAS” and starts the CAL PURGE delay.
6. CAL MODE will be complete after the end of the CAL PURGE delay.

The flow chart in Figure 2-7 illustrates the above procedure. up arrow, CAL, Next & Edit labels indicate keystrokes (down arrow/CAL is a dual purpose key). The CAL MODE information screen (top of the chart) is available for advanced users to see Offset / Gain calibration constants and live analog to digital converter (A/D) counts. Span Gas calibration values may also be edited from this screen. Holding the up arrow key for 5 seconds during CAL MODE displays this screen.

Unity Gain may be used at anytime to cancel incorrect calibrations and start again.

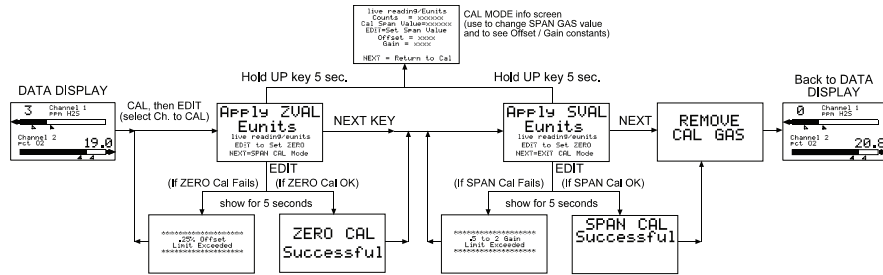

Figure 2-7. Cal Mode Flow Chart

## 2.3 System Configuration Menus

Several items needing configuration are not specific to either channel but affect the entire system. These are located in the system tree entry menu shown on the left side of Figure 2-1. System menus are accessed by pointing to the desired item and pressing Edit. The Diagnostics menu group (I) is useful for testing relay and analog I/O without stimulating the input.

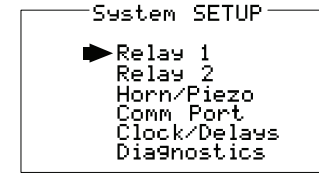

Figure 2-8. System Configuration Menu

### 2.3.1 Relay 1 / Relay 2 Menus

The **Relay 1** & **Relay 2** menus are identical except Relay 2 has an acknowledge feature that is useful if it controls an audible device. All other Relay 1 & Relay 2 features are identical and therefore are discussed only once.

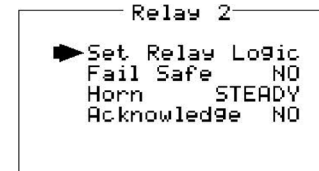

Figure 2-9. Relay Menus

- The Set Relay Logic menu shown below in Figure 2-10 offers additional “voting” flexibility by controlling the channel alarm combinations that will trip this common alarm relay. “OVR” on the menu’s right side stands for override and means ANY of the selected alarms will activate the relay. The “OR” / “AND” columns work together based upon the following logic equation:

[AND column selections] ANDED WITH [OR column selections] = relay activation.

For example, if Ch1A1 & Ch2A1 are selected in the AND column and Ch1A2 & Ch2A2 are selected in the OR column, the logic equation is [Ch1A1 AND Ch2A1] ANDED WITH [Ch1A2 OR Ch2A2]. This requires both A1s along with either A2 to activate the relay.

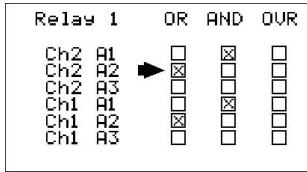

Figure 2-10. Set Relay Logic

- **Failsafe** controls relay activation for the common relays. Failsafe ON causes these relays to de-energize during alarm conditions and energize when there is no alarm. With Failsafe active, a power failure forces the relay contact to the alarm position.
- **Horn** controls how activating this relay will affect the horn driver circuit connected to J2 on the motherboard. Choices are NO, STEADY or PULSE (Ex.: The horn can be set to *Pulse* for warning, alarm levels and set to *Steady* for high alarm levels. Thus, personnel can know which alarm level is present by based on the pulsing or steady horn).
- Turning **Acknowledge** ON (not allowed on Relay 1) allows Relay 2 to be deactivated by an Alarm Reset during alarm conditions. This is useful if another audible device is being driven by the relay. The acknowledge feature is not available for Relay 1 since it is often used for driving a warning light and Relay 2 for driving a horn. Using Acknowledge (thus deactivating) when horn and light are activated could be dangerous since this deactivates both and no indication of the High alarm remains.

## 2.3.2 Horn / Piezo Menu

- The HA20 display PCB is equipped with a small audible piezo (NEMA 4X housing only) that chirps when keys are pressed providing an audible feedback to the operator. It also may be set to audibly indicate alarm conditions by selecting YES in the **Piezo On** menu option (Figure 2-11). This piezo will then mimic the Horn settings menus described in [Section 2.3.1](#).
- The Horn ACK menu item determines if the Horn Driver output may be acknowledged by an Alarm Reset. YES causes an Alarm Reset to silence the horn even though an alarm condition remains active.

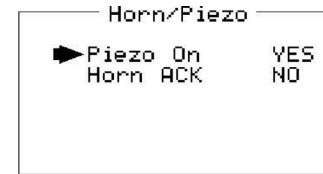

Figure 2-11. Horn/Piezo Menu

## 2.3.3 Comm Port Menu

The system **Comm Port** menu allows setting RTU address for the optional slave Modbus serial port. This slave port may be used to transfer HA20 data to a host device such as a PC, PLC, DCS or even another Honeywell Analytics Controllers. The slave port is addressable, allowing many HA20 controllers to be connected to a single RS-485 cable.



Figure 2-12. Communication Port Menu

## 2.3.4 Clock / Delays Menu

- The HA20 monitors signals from sensors that may require varying times to stabilize after power is applied. The **Startup Delay** menu item allows setting how long alarm relays remain disabled after power is applied.
- **Cal Delay** determines how long alarm relays are inhibited after completing a calibration.
- The HA20 is equipped with a 24-hour clock and calendar. **Time** and **Date** menu items are for setting the correct time and date. Time of day must be entered in 24 hour mode. For example, 6:00:00 PM = is indicated as 18:00:00.

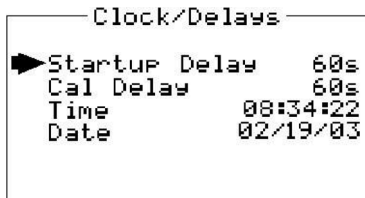

Figure 2-13. Clock/Delay Menu

## 2.3.5 Diagnostics Menu



### WARNING

**Alarm processing is halted with the Diagnostics mode active.**

The Diagnostics menu (Figure 2-14) is useful for testing standard and optional Input / Output devices such as relays and 4-20mA outputs. Diagnostic menu items are described below:

**Output Zero / Output Span** DAC value (digital to analog converter) menu items are set at the factory to calibrate optional 10-0223 4-20mA Output boards. If field adjustment is required, monitor the 4-20mA output and set the Output Zero DAC value for 4mA on each channel then set the Output Span DAC value for 20mA on each channel. These

menu items may also be used to drive 4-20mA into receiver devices without stimulating sensor inputs.

**Input Min / Max** ADC (analog to digital converter) menu items are set at the factory with default values for each channel of 200 to 1000 counts. These settings may be utilized to affect what input values provide ZERO and SPAN readouts. For example, if an application required 8mA input to read ZERO at 400 counts, an Input Min setting of 400 would accomplish this.

Common Relays menu item allows manual activation of the common relays and optional local audible piezo.

Discrete Relays menu item allows manual activation of the optional 10-0222 Discrete Relay boards.

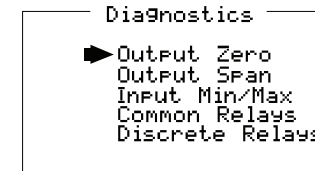

Figure 2-14. Diagnostics Menu

## 2.4 System Security Menu

A 4-digit Pass Code entered and confirmed in this menu item locks all menus. Viewing menus is not denied but attempts to edit variables flashes the Locked message on the LCD.

Authorized individuals locking the system should first enter a name, phone #, or other contact information in the 12 character field on the top line of the **System SECURITY** screen. To lock or unlock the system the correct 4 digit authorization number must be entered into the Pass Code field. It is very important to remember the 4 digit code since the factory must be consulted if it is lost.

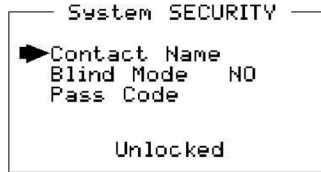

Figure 2-15. System Security Menu

---

**3 Motherboard Interface  
PCB**

## 3 Motherboard Interface PCB (P/N 10-0215)

The HA20 Motherboard shown in Figure 3.2 is the interface between the Display / CPU assembly and all other system I/O devices. The Display / CPU assembly attaches to the motherboard with 4-standoffs and connects via ribbon cable to S1. Several input options, described in the following sections, are available that may be installed into the Sensor Input Option P1 connector located on the lower left side of the motherboard. The middle position P2 connector is for the 10-0223 4-20mA Output option and the right position P3 connector is for the 10-0222 Discrete Relay option. Other option devices such as Modbus RTU RS-485, Ethernet and a data logger may also be installed to connectors located on the Motherboard.

The Motherboard PCB contains a 24 VDC universal input (100-240 VAC) switching power supply with up to 350mA available at TB3 Auxiliary Power Output terminals (Figure 3.1). If AC power is unavailable, or if a DC battery back-up supply is needed, TB1 provides terminals for DC power input. Blocking diodes isolate internal and external DC supplies as shown in Figure 3-1.

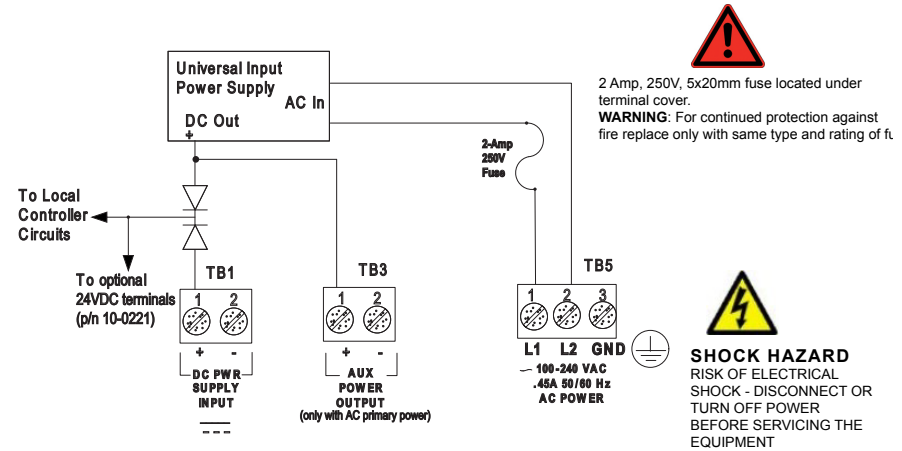
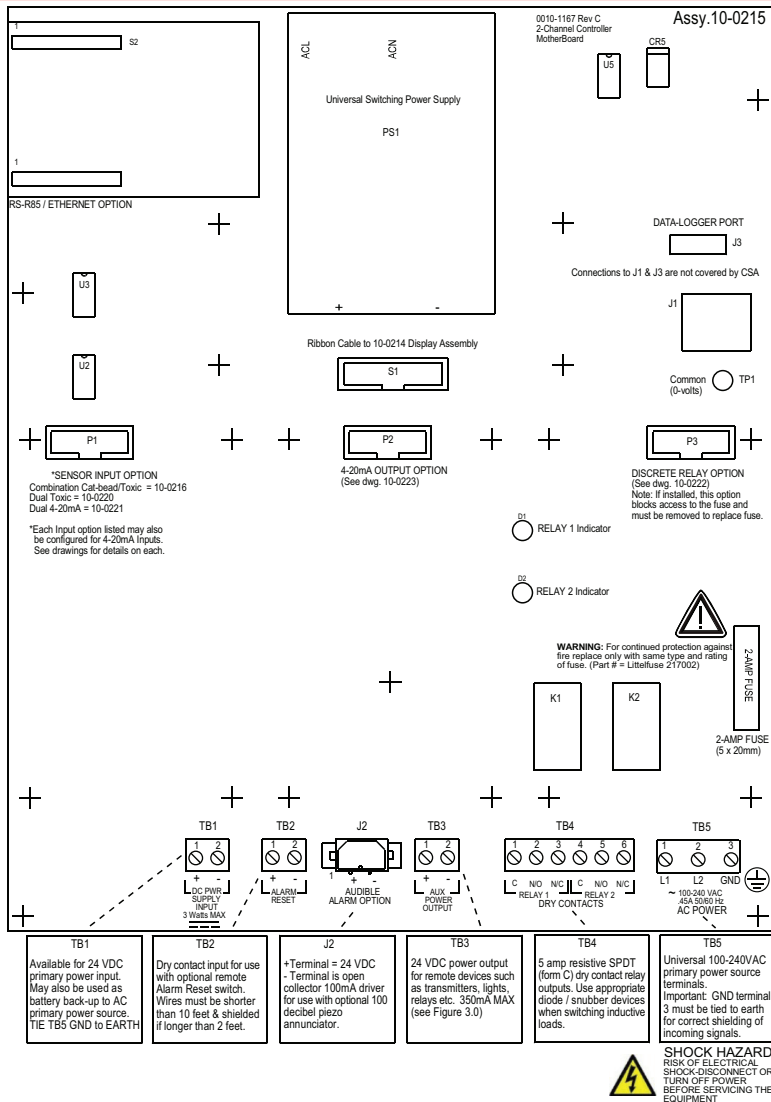

Figure 3-1. DC Power Supply Schematic

TB2 offers field terminals for a remote alarm reset switch. The motherboard also includes alarm relays 1 & 2 (K1 & K2) and their indicating LED's. TB4 provides field wiring terminals for these relays. TB5 is for connection to the 85-240 VAC power source. J2 is a 2-pin connector for powering the optional part # 1000-1892 audible annunciator.



## 3.1 Input / Output Optional PCB's

P1, P2 and P3 connectors on the motherboard offer unique positions for I/O options described in this section. A screen appears briefly after power up indicating what options types are connected.

### 3.1.1 Optional Analog Input PCB (P/N 10-0221-2)

Transmitter input PCB option #10-0221, shown in Figure 3-3, is available for interfacing the HA20 to field transmitters with 4-20mA or voltage outputs (0-2 VDC max). TB1 provides Channel 1 & Channel 2 + / - terminals for receiving analog inputs. R1 / R2 are 100 ohm precision socketed termination resistors between each channel's signal + and - 4-20mA input terminals. These may be removed if voltage inputs are to be applied. TB2 provides 2-terminals connected to the HA20 internal 24 VDC power supply for powering external transmitters. Figure 3.3 shows correct wiring for both 2-wire and 3-wire transmitters.

Figure 3-2. Motherboard Relays and Terminals



- \*R1 = Ch1 100 ohm 4-20mA terminator
- \*R2 = Ch2 100 ohm 4-20mA terminator
- \*R3 = Ch3 100 ohm 4-20mA terminator
- \*R4 = Ch4 100 ohm 4-20mA terminator
- \*Spare = Spare 100 ohm 4-20mA terminator

\* These 5 resistors are socketed for easy replacement.

Terminators are connected between each channel's HI & LO terminals.

LO = 24VDC Power Supply Common  
24VDC = 24VDC Power Supply + output

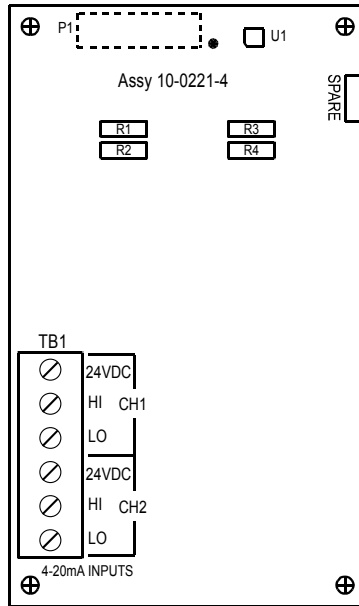

**Figure 3-3. Analog Input Board**

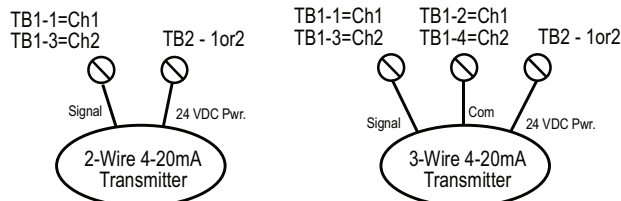

**Figure 3-4. Wiring for 2- and 3-wire Transmitters**

## 3.1.2 Optional Discrete Relay PCB's

(P/N 10-0222)

The optional Discrete Relay PCB, shown in Figure 3-6, adds six 5 amp, form C relays. Each relay is associated to either A1, A2 or A3 for channel 1 or 2. Many HA20 applications utilize the standard equipped Relay 1 / Relay 2 (see [Section 2.3.1](#)) and do not require optional discrete relays for each of the 6 alarms events (2 A1's, 2 A2's & 2 A3's).

**WARNING**

**All mechanical (dry contact) relays are rated at 5 Amp for 28 VDC and 250 ~VAC RESISTIVE loads. IMPORTANT: Appropriate diode (DC loads) or MOV (AC loads) snubber devices must be installed with inductive loads to prevent RFI noise spikes.**

AC or DC power supplies to relays on the 10-0222 Discrete Relay PCB option must be the same for each relay. Example: 24VDC should not be the power switched by one relay and 115VAC by others.

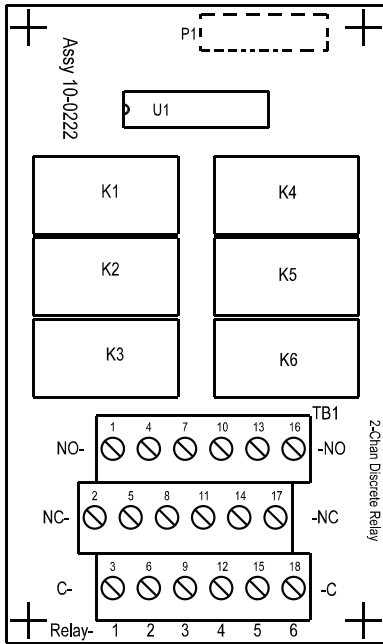

Figure 3-6. Optional Discrete Relay PCB's (P/N 10-0222)



Note:  
When installed, this option blocks access to the fuse and must be removed to replace a blown fuse.  
**WARNING:** For continued protection against fire replace only with same type and rating of fuse.

K1, K2, K3, K4, K5 & K6 are programmable, as described in section 2.3.1  
TB1 terminals 1,4,7,10,13 & 16 are Normally Open Contacts for K1-K6  
TB1 terminals 2,5,8,11,14 & 17 are Normally Closed Contacts for K1-K6  
TB1 terminals 3,6,9,12,15 & 18 are Common (pole) Contacts for K1-K6  
Contacts are rated for 5 amp resistive loads. Arc suppressing snubber devices should be used for switching inductive loads.

### 3.1.3 Optional 4-20mA Analog Output Board (P/N 10-0223)

An optional 4-20mA analog output board, shown in Figure 3-7, may be added. Each channel's output will transmit 4mA for 0% readings and 20mA for 100% readings. **Make certain that the mA loop output is set to LATCHING on reading devices connected to the HA40**

If the HA20 primary power is 100 – 240 VAC, 4-20mA outputs are capable of driving 20mA through a 750 ohm load. Outputs are self powered and DC power should not be provided by the receiving device. Precision calibration of the 4-20mA output DAC (digital to analog converter) is accomplished via the Diagnostics menu as described in [Section 2.3.5](#).

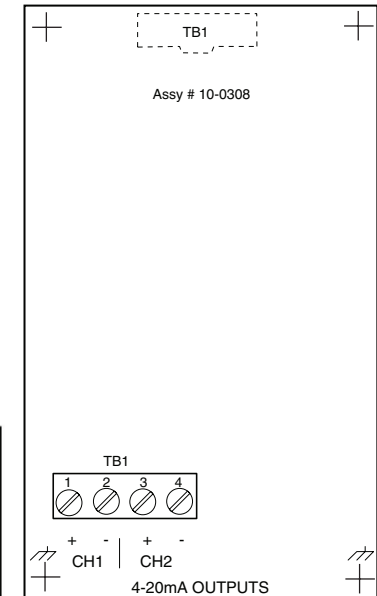

Optional 4-20mA Output Notes  
4-20mA Outputs are sourcing and 24 VDC power must not be supplied by the receiver device.  
Loop drive capability is 750 ohms with nominal 85-240 VAC power or 24 VDC power as the Controller primary power supply.

Figure 3-7. Optional 4-20mA Analog Output Board (P/N 10-0223)

## 3.2 Modbus RS-232 / RS-485 Interface Option (P/N 10-0253)

The 10-0253 Modbus option PCB adds both RS-232 and RS-485 Modbus RTU slave ports. Figure 3-8 shows this optional PCB which mounts to connectors on the upper right corner of the HA20 motherboard. TB1 provides two pairs of T/Rx terminals and a floating terminal for shield continuation. This makes it easy to multi-drop HA20s onto an RS-485 cable without doubling wires into the same screw terminals. RS-232 interface may be made by connecting to DB9 connector S1. Section 3.2.1 lists all modbus registers and their function codes.

### **WARNING**

Follow correct IEEE RS-232 and RS-485 installation guidelines when using the 10-0253 option.

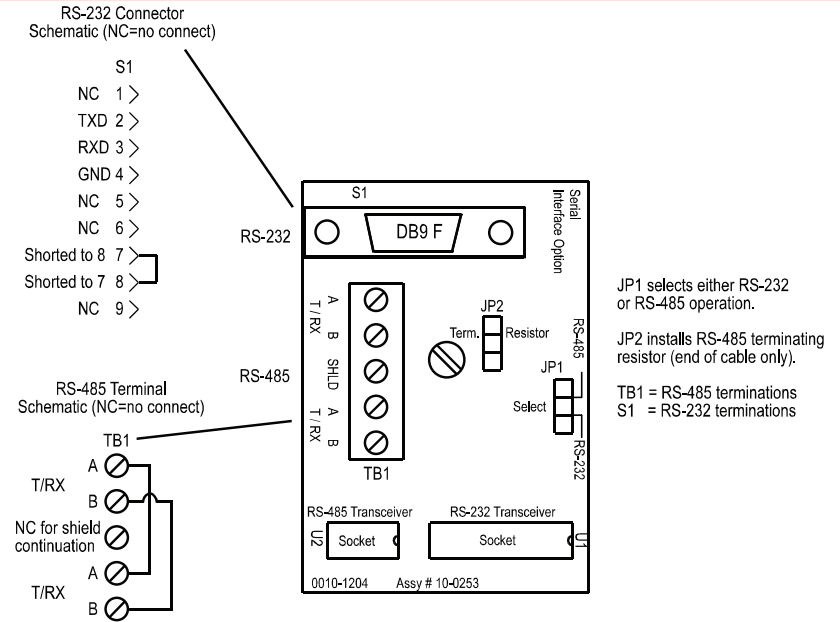

Figure 3-8. Modbus RS-232 / RS-485 Interface Option (P/N 10-0253)

## 3.2.1 Modbus Register And Function Code Summary

The following table identifies HA20 Modbus register locations and function codes.

VARIABLE	ALIAS	READ FUNCTION CODE	WRITE FUNCTION CODE
<b>Read/Write Coils:</b>			
Alarm Ack/Reset 2001	1	5	
<b>NOTE:</b> After writing a TRUE to this register, the HA20/40 will reset it to FALSE.			
<b>Read Only Discrete:</b>			
Chan 1 Alarm 1	12001	2	NA
Chan 1 Alarm 2	12002	2	NA
Chan 1 Alarm 3/Flt	12003	2	NA
Chan 2 Alarm 1	12004	2	NA
Chan 2 Alarm 1	12005	2	NA
Chan 2 Alarm 3/Flt	12006	2	NA
Relay 1	12007	2	NA
Relay 2	12008	2	NA
<b>Read Only Registers:</b>			
A2D Raw Chan 1	31001	4	NA
A2D Raw Chan 2	31002	4	NA
10 bit value representing the A2D value of 0 to 1023 for -25 to 103 %FS (197=0% & 1003=100%).			
D2A Chan 1	31003	4	NA
D2A Chan 2	31004	4	NA
10 bit value representing the D2A value of 0 to 1023 after all cal features are applied.			

Chan 1 Status	31005	4	NA
Chan 2 Status	31006	4	NA

16 bit status word bit assignment for each channel.

ALARM1_BELOW_BIT	BIT0
ALARM2_BELOW_BIT	BIT1
ALARM3_BELOW_BIT	BIT2
ALARM1_LATCH_BIT	BIT3
ALARM2_LATCH_BIT	BIT4
ALARM3_LATCH_BIT	BIT5
ALARM3_ACTIVE_BIT	BIT6
CHANNEL_DISABLED_BIT	BIT7
CHANNEL_CAL_BIT	BIT8

System Status Word	31007	4	NA
--------------------	-------	---	----

16 bit status word bit assignment for system status.

PIEZO_DRIVE	BIT6
HORN_ACK	BIT7
K1_HORN_DRIVE	BIT8
K2_HORN_DRIVE	BIT9
K1_HORN_PULSE	BIT10
K2_HORN_PULSE	BIT11
K1_FAILSAFE	BIT12
K2_FAILSAFE	BIT13
K2_ACK	BIT14
LOCK	BIT15

Alarm Status Word	31008	4	NA
-------------------	-------	---	----

16 bit status word bit assignment for system status.

CHAN_1ALM_1	BIT0
CHAN_1ALM_2	BIT1
CHAN_1ALM_3	BIT2
CHAN_2ALM_1	BIT3
CHAN_2ALM_2	BIT4
CHAN_2ALM_3	BIT5
RELAY_1	BIT6
RELAY_2	BIT7

### Memory Floating Point:

#### NOTE:

Returned as 15 bit 2s complement with +- 5% over/underrange applied.. Therefore this must be considered when scaling values to be displayed at the Workstation. The following equation may be used to determine a value for display.

Display Value = MODBUS Value [ (Span Value -Zero Value) 1.1] + {Zero Value - [(Span Value - Zero Value) .05]} 32767

FP Value Chan 1	33001	4	NA
FP Value Chan 2	33002	4	NA

### Memory Reals:

#### NOTE:

Real value represents float value without the decimal point such as 123.4 is returned as 1234. Decimal divisor is returned as 1, 10, 100, or 1000 for decimal position of 1, 2, 3, or 4, where 123.4 would return the value 10.

Chan 1 Zero Real	41001	4	NA
Chan 1 Zero Divisor	41002	4	NA
Chan 1 Span Real	41003	4	NA
Chan 1 Span Divisor	41004	4	NA
Chan 1 Alarm 1 Real	41005	4	NA
Chan 1 Alarm 1 Divisor	41006	4	NA
Chan 1 Alarm 2 Real	41007	4	NA
Chan 1 Alarm 2 Divisor	41008	4	NA
Chan 1 Alarm 3 Real	41009	4	NA

### Binary Cal Data:

Chan 1 A2D MIN	41021	4	NA
Chan 1 A2D MAX	41022	4	NA
Chan 1 D2A MIN	41023	4	NA
Chan 1 D2A MAX	41024	4	NA
Chan 2 A2D MIN	41025	4	NA
Chan 2 A2D MAX	41026	4	NA
Chan 2 D2A MIN	41027	4	NA
Chan 2 D2A MAX	41028	4	NA

Min and Max calibration points for the A/D and D/A converters.

### Memory ASCII Strings:

User Info Chan 1	40401-40405	3	NA
User Info Chan 2	40406-40410	3	NA

10 ASCII characters (2 per register) assigned to the unit identifier read as bytes.

EUNITS Chan 1	40411-40415	3	NA
EUNITS Chan 2	40416-40420	3	NA

10 ASCII characters (2 per register) assigned to the engineering units read as bytes.

Chan 1 ASCII Reading	40421-40423	3	NA
Chan 2 ASCII Reading	40424-40426	3	NA

6 ASCII characters (2 per register) reflecting the display readout..

### Firmware Version:

Version	40427-40428	3	NA
---------	-------------	---	----

4 ASCII characters (2 per register) reflecting the firmware version.





---

**4 Enclosures**

---



## 4 Enclosures

The HA20 controller enclosures are shown in Figures 4-1, 4-2, and 4-3. Non-metallic enclosures are not grounded by metal conduit. For internal ground points to be grounded to earth, the TB5 – GND terminal must have a proper earth ground connection (see [Figure 3-2](#)).

### 4.1 HA20PCS NEMA 4X/HA20SS NEMA 4 Steel Enclosures

The HA20PCS (painted carbon steel) and HA20SS (stainless steel) enclosures are shown in Figure 4.1.

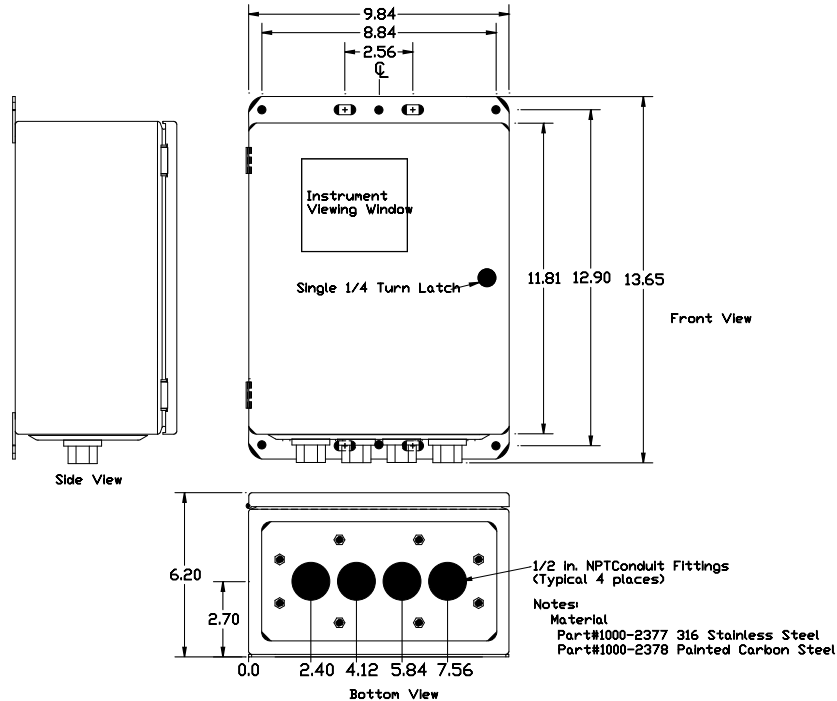

Figure 4-1. NEMA Painted Carbon Steel or Stainless Steel Enclosure

### 4.2 HA20PY NEMA 4X Polycarbonate Enclosure



Nonmetallic enclosures do not provide grounding between conduit connections. Use grounding type bushings and jumper wires. All field wiring must have insulation suitable for at least 250V.

The HA20PY polycarbonate enclosure is shown in Figure 4.2.

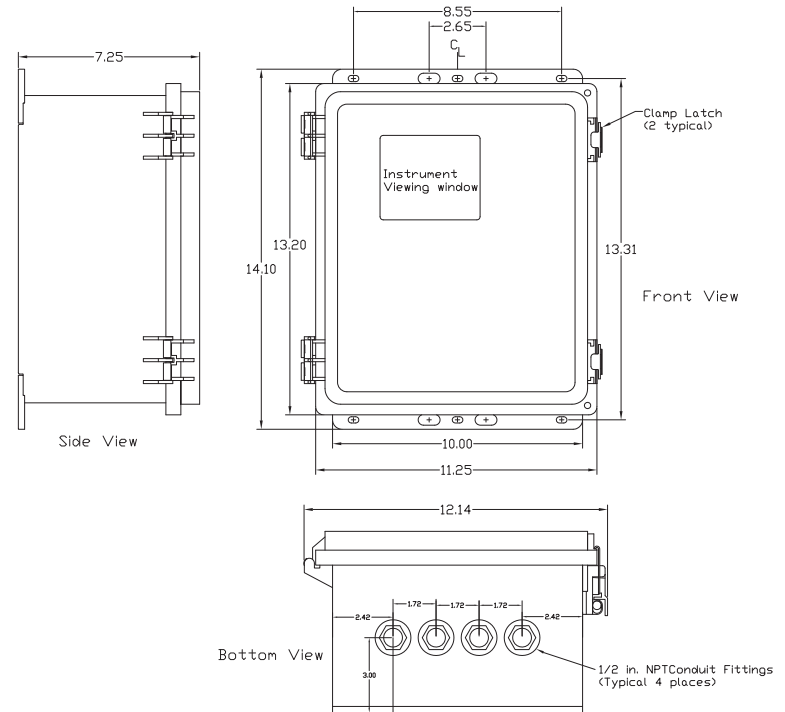
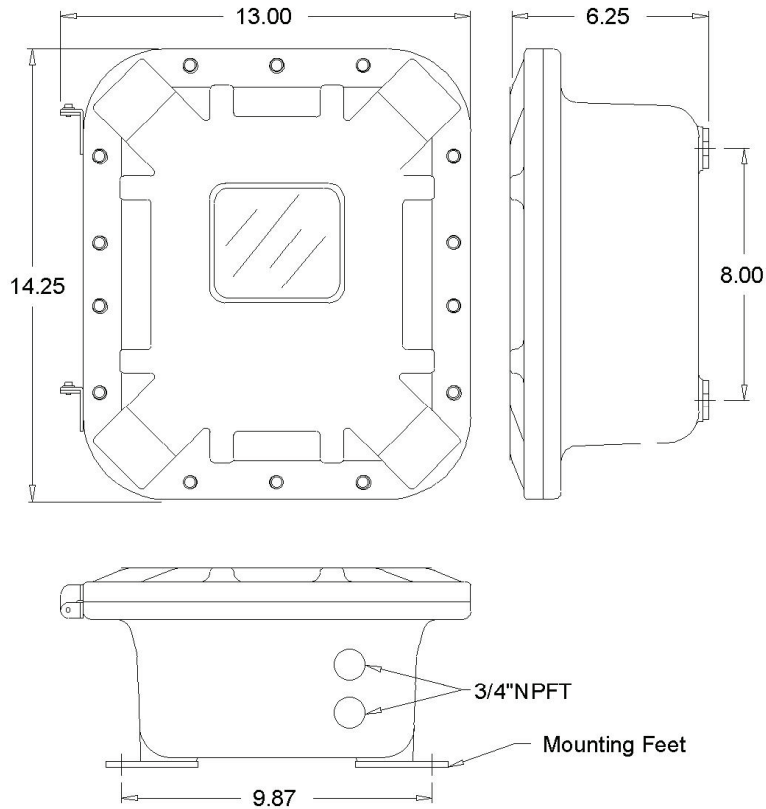

Figure 4-2. NEMA Polycarbonate Enclosure

## 4.3 HA20XP NEMA 7 Explosion-Proof Wall Mount Enclosure

The HA20XP enclosure shown in Figure 4.3 is an aluminum NEMA 7 wall mount enclosure designed for use in potentially hazardous areas.



**Figure 4-3. NEMA 7 Explosion-Proof Wall Mount Enclosure**

---

**5 Parts List**

---

## 5 Parts List

<b>Base Units</b>	
HA20N4	NEMA 4X Enclosure incl Magnetic Keypad for nonintrusive control, 4-20mA
HA20XP	NEMA 7 Enclosure incl Magnetic Keypad for nonintrusive control, 4-20mA
<b>I/O Options</b>	
10-0221-2	Dual 4-20mA Analog INPUT PCB
10-0223	Dual 4-20mA Analog OUTPUT PCB
<b>Options and Accessories</b>	
10-0222	Relay Option to add six 5 amp Form C relays
10-0227	Modbus RS-232/RS-485 Option
10-0284	Division 2 red xenon strobe light (includes mounting to top of NEMA 4 models)
1000-1892	100db piezo audible (NEMA 4X enclosure only)

---

# 6 Specifications

---

## 5 Specifications

Input power:	100-240 VAC, 50/60 Hz 24 VDC
DC output power:	15 watts (internal supply) or 50 watts (internal supply)
Relay output rating:	5A, 28 VDC or 250 VAC (resistive load)
Optional relay output rating	5A, 28 VDC or 250 VAC (resistive load)
Optional milliamp loop output	10 bit 4-20mA output. Max load 800 ohms with nominal 24 VDC
Communication:	RS232 Modbus
Length of communication lines:	
Operating environment:	Industrial
Operating temperature range:	-25 to 50°C (-13°F to 122°F)
Operating humidity range:	0 to 90% RH non-condensing
Operating altitude:	2000m (6562 ft)
Audible alarm:	100 dB
Display:	128 x 64, backlight graphic LCD
Visual Indicators:	6 LED status indicators
Pollution degree:	N4: 3
Enclosure (N4):	NEMA 4X, Div. 2, Groups A,B,C,D, Category II
Enclosure (XP):	NEMA 7, Div. 1 & 2, Groups B,C,D
Enclosure	NEMA 4 painted carbon steel
Enclosure	NEMA 4X SS316
Enclosure	NEMA 4X Polycarbonate
Dimensions (H x W x D):	N4: 10.32" x 8.92" x 3.17" (23.62 x 22.66 x 8.05cm) XP: 15.10" x 13" x 6.25" (36.2 x 33 x 15.88cm)
Weight:	N4: 2.27 Kg    XP: 18.14 Kg

Certifications:	CSA C22.2 No. 1010-1, ISA S82.02 CSA C22.2 No 152 (for combustibles using mA input) UL 1604/C22.2 No. 213 (NEMA 4X = Div 2, Gr A, B, C, D; NEMA 7 = Div 1, Gr , B, C, D EN55011 & EN61000 (CE mark))
-----------------	---

---

**7 Warranty**

---

## Honeywell Analytics Warranty Statement

All products are designed and manufactured to the latest internationally recognized standards by Honeywell Analytics under a Quality Management System that is certified to ISO 9001.

As such, this instrument is warranted under proper use, to the original end-user purchaser, against any defects in materials or workmanship related failures for a period of 12 months from the date of first turn-on or 18 months from delivery from Honeywell Analytics to the customer, whichever is less. During this period, Honeywell Analytics will repair or replace defective parts on an exchange basis, F.O.B. to approved service centers on a global basis.

This warranty does not cover damage caused by accident, abuse, abnormal operating conditions or extreme poisoning of the sensor cartridge.

Defective equipment must be returned to Honeywell Analytics for repair. Before returning materials for repair or replacement, the Customer must obtain a Service Event Number (SE#) by contacting Honeywell Analytics Service in advance; include a detailed report stating the nature of the defect and ship the equipment prepaid to Honeywell Analytics' factory. If no detail report is included, Honeywell Analytics reserves the right to charge an investigative fee (prices available upon request) before any repair or replacement is performed. Returned goods must detail the Service Event Number (SE#) clearly on the package.

Service in the field or at the customer's premises is not covered under these warranty terms. Time and travel expenses for on-site warranty services will be charged at Honeywell Analytics' normal billing rates. Contact your Honeywell Analytics representative for information on available Service Contracts.

Honeywell Analytics shall not be liable for any loss or damage whatsoever or howsoever occasioned which may be a direct or indirect result of the use or operation of the Contract Goods by the Buyer or any Party.

This warranty covers the controller and parts sold to the Buyer only by authorized distributors, dealers and representatives as appointed by Honeywell Analytics. This warranty does not cover defects attributable to improper installation, repair by an unauthorized person or the use of unauthorized accessories/parts on the product. A warranty claim will only be accepted if a proof of purchase is submitted and all conditions obtained within this Warranty are met.

Honeywell Analytics reserves the right to validate any warranty claim prior to processing. Upon acceptance of a warranty claim, Honeywell Analytics will repair or replace the defective product free of charge. The initial warranty period is not extended by virtue of any works carried out there after.

Instruments which have been repaired or replaced during the warranty period are warranted for the remainder of the unexpired portion of the original warranty period. Honeywell Analytics is released from all obligations under its warranty in the event repairs or modifications are made by persons other than its own authorized personnel, unless such work is authorized in writing by Honeywell Analytics.

Honeywell Analytics reserves the right to change this policy at any time. Contact Honeywell Analytics for the most current warranty information.



**Find out more**

[www.honeywellanalytics.com](http://www.honeywellanalytics.com)

**Customer business center  
Americas**

Honeywell Analytics  
404 Barclay Boulevard  
Lincolnshire, IL 60069  
Tel: +1 847 955 8200  
Toll free: +1 800 538 0363  
Fax: +1 847 955 8208  
detectgas@honeywell.com

**Europe, Middle East and Africa**

Life Safety Distribution AG  
Wilstrasse 11-U11  
CH-8610 Uster  
Switzerland  
Tel: +41 (0)1 943 4300  
Fax: +41 (0)1 943 4398  
gasdetection@honeywell.com

**Europe, Middle East and Africa**

[ha.global.service@honeywell.com](mailto:ha.global.service@honeywell.com)

[www.honeywell.com](http://www.honeywell.com)

**Asia Pacific**

Honeywell Analytics  
#508, Kolon Science Valley (I)  
187-10 Guro-Dong, Guro-Gu  
Seoul, 152-050 Korea  
Tel: +82 2 2025 0300  
Fax: +82 2 2025 029

[anapitics.ap@honeywell.com](mailto:anapitics.ap@honeywell.com)

**Please Note:**

While every effort has been made to ensure accuracy in this publication, no responsibility can be accepted for errors or omissions.  
Data may change, as well as legislation, and you are strongly advised to obtain copies of the most recently issued regulations, standards and guidelines.  
This publication is not intended to form the basis of a contract.



**Tollfree in Western Canada: 1-888-388-1592**  
**microwatt.com • mwsales@microwatt.com**

**Honeywell**