



## Technical Manual

- [TOC](#)
- [General Description](#)
- [Basic Operation](#)
- [Main I/O Interface PCB](#)
- [System Diagnostics](#)
- [Modbus® RS485 Ports](#)
- [HA71 Enclosures](#)
- [Ordering Information](#)
- [Warranty](#)

## Important Safety Issues

The following symbols are used in this manual to alert the user of important instrument operating issues:



This symbol is intended to alert the user to hazards or unsafe practices which could result in severe personal injury or death.



This symbol is intended to alert the user to the presence of important operating and maintenance (servicing) instructions.



This symbol is intended to alert the user to the presence of dangerous voltage within the instrument enclosure that may be sufficient magnitude to constitute a risk of electric shock.

### **WARNINGS:**

- Shock Hazard - Disconnect or turn off power before servicing this instrument.
- NEMA 4X wall mount models should be fitted with a locking mechanism after installation to prevent access to high voltages by unauthorized personnel (see Figure 6-2).
- Only the combustible monitor portions of this instrument have been assessed by CSA for C22.2 No. 152 performance requirements.
- This equipment is suitable for use in Class I, Division 2, Groups A,B,C and D or non-hazardous locations only.
- Use a properly rated CERTIFIED AC power (mains) cable installed as per local or national codes
- A certified AC power (mains) disconnect or circuit breaker should be mounted near the controller and installed following applicable

local and national codes. If a switch is used instead of a circuit breaker, a properly rate CERTIFIED fuse or current limiter is required to installed as per local or national codes. Markings for positions of the switch or breaker should state (I) for on and (O) for off.

- Clean only with a damp cloth without solvents.
- Equipment not used as prescribed within this manual may impair overall safety.

### **WARNING**

Explosion hazard- substitution of components may impair suitability for Class I, Division 2.

### **WARNING**

Explosion hazard- do not replace fuse unless power has been switched off or the area is known to be non-hazardous.

### **WARNING**

Explosion hazard- do not disconnect equipment unless power has been switched off or the area is known to be non-hazardous.

## Table of Contents

### **1 General Description**

<b>1.0 General Description .....</b>	<b>1-2</b>
<b>1.1 Data Display Screens .....</b>	<b>1-2</b>
1.1.1 Trend Screen.....	1-2
1.1.2 Bar Graphs Screen .....	1-3
1.1.3 Combination Screen .....	1-3
<b>1.2 Specifications .....</b>	<b>1-3</b>
1.2.1 DC Power Supply Requirements .....	1-3
1.2.2 150 Watt AC – 24VDC Power Supply .....	1-3
1.2.3 Relays .....	1-4
1.2.4 Ambient Temperature Range .....	1-4
1.2.5 Humidity Range .....	1-4
1.2.6 Altitude .....	1-4
1.2.7 Housings .....	1-4
1.2.8 Non-Intrusive Magnetic Keypad .....	1-4
1.2.9 Approvals .....	1-4

### **2 Basic Operation**

<b>2.0 Basic Operation .....</b>	<b>2-2</b>
<b>2.1 Setup Menu Configuration .....</b>	<b>2-2</b>
2.1.1 Changing Menu Variables Using the Keypad ..	2-2
<b>2.2 Channel Configuration Menus .....</b>	<b>2-3</b>
2.2.1 Channel Setup Entry Menu.....	2-3
2.2.2 Alarm 1 / Alarm 2 / Horn Relay Set-Up Menu .	2-3
2.2.3 Alarm 3 / Fault Alarm Menu .....	2-4
2.2.4 Data From? Menu to Set Input Source .....	2-4
2.2.5 MIN/MAX Raw Counts Menu .....	2-5

2.2.6 Marker Menus .....	2-6
2.2.7 Linearization Menu .....	2-6
2.2.8 Configure Menu .....	2-6
2.2.9 Eunits / Measurement Name ASCII Data Fields.	2-6
2.2.10 Input Measurement Range .....	2-7
2.2.11 Decimal Point Resolution.....	2-7
2.2.12 Turning off Unused Channels.....	2-7
2.2.13 Copy Data To? .....	2-7
2.2.14 CAL Mode .....	2-7

### **2.3 System Configuration Menus .....**

2.3.1 Common Alarm Relays 1 and 2 .....	2-9
2.3.2 10-0195 Discrete Relay “Failsafe” Mode ....	2-10
2.3.3 Common Horn Relay and Local Piezo.....	2-10
2.3.4 Modbus® Master / Slave Serial Port Menus.	2-11
2.3.4 Eight / Sixteen Channel Modes .....	2-11

### **2.4 Authorization Mode .....**

### **2.5 LCD Contrast Adjustment.....**

### **3 Main I/O Interface PCB**

#### **3.0 Main I/O Interface PCB .....**

#### **3.1 Input / Output Optional PCBs .....**

3.1.1 Optional Analog Input PCB.....	3-3
3.1.2 Optional Discrete Relay PCB.....	3-4
3.1.3 Optional *Bridge Sensor Input Board.....	3-5
3.1.4 Catalytic Bead Sensor Initial Setup .....	3-5
3.1.5 Optional RTD / 4-20mA Analog Input Board ..	3-7
3.1.6 Optional 4-20mA Analog Output Board .....	3-8

## Table of Contents

<a href="#">3.1.7 Optional Clock/Printer Interface Board .....</a>	<a href="#">3-9</a>
<a href="#">3.1.8 Clock / Printer System Set-Up Menu .....</a>	<a href="#">3-10</a>
<a href="#">3.1.9 Optional 24VDC 150 Watt Power Supplies..</a>	<a href="#">3-10</a>

### **[4 System Diagnostics](#)**

<a href="#">4.0 System Diagnostics .....</a>	<a href="#">4-2</a>
--	---------------------

### **[5 Modbus® RS-485 Ports](#)**

<a href="#">5.0 Modbus® RS-485 Ports .....</a>	<a href="#">5-2</a>
<a href="#">5.1 Modbus® Slave Register Locations .....</a>	<a href="#">5-2</a>

### **[6 HA71 Enclosures](#)**

<a href="#">6.0 HA71 Enclosures .....</a>	<a href="#">6-2</a>
<a href="#">6.1 HA71PM Panel / Rack Mount Enclosure .....</a>	<a href="#">6-2</a>
<a href="#">6.2 HA71N4 NEMA 4X Fiberglass Wall Mount Encl .</a>	<a href="#">6-3</a>
<a href="#">6.3 HA71SS NEMA 4X 316 Stainless Steel Wall Mount Encl.</a>	<a href="#">6-5</a>
<a href="#">6.4 HA71XP NEMA 7 Explosion-Proof Wall Mount Encl.</a>	<a href="#">6-6</a>
<a href="#">6.5 HA71 Main I/O and Option PCB Footprint Dimensions .....</a>	<a href="#">6-7</a>

### **[A Ordering Information](#)**

<a href="#">A Ordering Information .....</a>	<a href="#">A-2</a>
--	---------------------

### **[B Warranty](#)**

<a href="#">Honeywell Analytics Warranty Statement .....</a>	<a href="#">B-2</a>
--	---------------------

---

# 1 General Description

---

## 1.0 General Description

The Honeywell Analytics HA71 Sixteen Channel Controller is designed to display and control alarm event switching for up to sixteen sensor data points. It may also be set as an eight channel controller for applications needing fewer inputs. Alarm features such as *ON* and *OFF* delays, *Alarm Acknowledge*, and a dedicated horn relay make the HA71 well suited for many multi-point monitoring applications. Data may be input to the HA71 by optional analog inputs or the standard Modbus® RTU *master* RS-485 port. A Modbus® RTU *slave* RS-485 port is also standard for sending data to PC's, PLC's, DCS's, or even other HA71 Controllers. Options such as analog I/O and discrete relays for each alarm are easily added to the addressable I<sup>2</sup>C bus. Option boards have 8 channels and therefore require 2 boards for 16 channel applications.

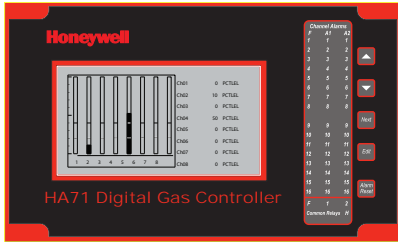

**Figure 1-1. HA71 Front Panel** configuration is through user friendly menus and all configuration data is retained in non-volatile memory during power interruptions. The HA71 front panel is shown below in Figure 1.0 displaying the 8 channel bar graph screen.

## 1.1 Data Display Screens

The HA71 Controller offers 3 distinct graphic displays for depicting the monitored data:

- Bar Graphs
- 24 Hour Trend
- Combination.

### 1.1.1 Trend Screen

The HA71 Trend screen shown in Figure 1-2, displays a 24 hour trend of input data for the channel selected. Horizontal tic marks are each hour and vertical tic marks are each 10% of full scale. Dashed lines indicate alarm levels. The graphic LCD is 240 pixels wide so each pixel represents 1/10 hour, or 6 minutes worth of data. The trend is 100 pixels high so each represents 1% of full scale in amplitude. Since each data point must be collected for 6 minutes before it may be displayed, it is likely input values will fluctuate during this interval. Therefore, MAX, MIN and AVERAGE values are stored in RAM memory for each 6 minute subinterval. To accurately portray the trend, a vertical line is drawn between MIN and MAX values for each 6 minute subinterval. The AVERAGE value pixel is then left blank, leaving a gap in the vertical line. This is demonstrated in the *noisy* area of the 24 hour trend in Figure 1-2. If the MAX and MIN values are within 2% of each other there is no need for the vertical line and only the AVERAGE value pixel is darkened as in the *quiet* areas.

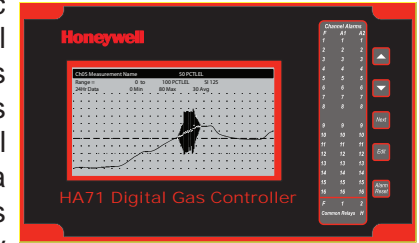

**Figure 1-2. Trend Screen**

The top portion of each trend screen indicates channel #, real time reading in engineering units, measurement name, range, and MIN, MAX and AVERAGE values for the preceding 24 hour period. The SI field on the top right indicates number of seconds remaining in the current 6 minute subinterval.

The top portion of each trend screen indicates channel #, real time reading in engineering units, measurement name, range, and MIN, MAX and AVERAGE values for the preceding 24 hour period. The SI field on the top right indicates number of seconds remaining in the current 6 minute subinterval.



## 1.1.2 Bar Graphs Screen

The HA71 Bar Graphs screen shown in Figure 1-3 allows all active channels to be viewed simultaneously. Both engineering units values and bar graph values are indicated in real time. Lines across the bars indicate the alarm trip points making it easy to identify channels at or near alarm. A feature in the Systems menu tree allows new alarms to always force the LCD to the bar graphs screen. This is useful for applications requiring channels with alarms to be displayed.

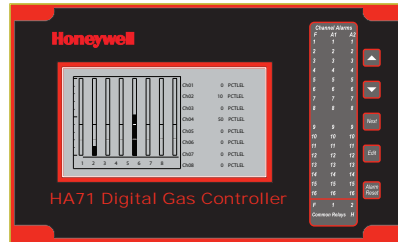

Figure 1-3. Bar Graphs Screen

## 1.1.3 Combination Screen

The HA71 Combination screen shown in Figure 1-4 offers a view of a single channel but displays the data as a 10 minute trend, bar graph and large engineering units. It is also useful for testing inputs for stability since MAX, MIN and AVERAGE values refresh each time this screen is selected. For example, to test stability over a one hour period for an input, begin timing as soon as the channel is selected. One hour later record the MAX, MIN and AVERAGE values. The difference between MAX and MIN indicates peak to peak excursions over the one hour period and AVERAGE is the average for the hour. Longer or shorter tests may

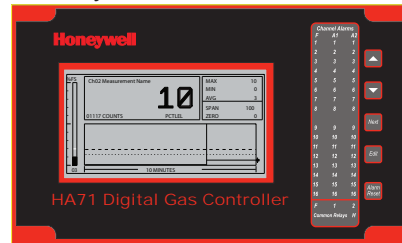

Figure 1-4. Combination Screen

also be run. The numeric value shown below the bar-graph indicates number of minutes samples have been taken. After 999 minutes the AVERAGE buffer overflows and the error message UPDATE appears in the AVERAGE field. Exiting this screen resets the buffer and clears the error message.

## 1.2 Specifications

### 1.2.1 DC Power Supply Requirements

Standard HA71 power requirements are 10-30VDC @ 3 watts applied to terminals 9 & 11 of TB2 on the standard I/O PCB (see [Section 3.0](#)). Optional features increase power consumption as described below:

- Discrete Relay PCB option; add 2 watts per PCB.
- Analog Input PCB option; add 1/2 watt.
- 4-20mA Output PCB option; add 1 watt.
- Catalytic Bead Sensor Input option; add 12 watts max (depends upon sensor power).
- TB2 terminals 10 & 12 of the standard I/O PCB provide a maximum of 500mA fused output power for powering of auxiliary external devices such as relays, lamps or transmitters. Power consumed from these terminals should be considered when calculating system power consumption.

### 1.2.2 150 Watt AC – 24VDC Power Supply

- 110-120 VAC @3.2A max
- 220-240VAC @ 1.6A max
- A slide switch on the front of the power supply selects AC input range.

The 10-0172 150 watt power supply ([Section 3.1.9](#)) is for powering the HA71 and up to 16 detectors. A minimum of 5 watts per channel is available for powering of external transmitters.

## 1.2.3 Relays

Common relays are standard for ALARM 1, ALARM 2, FAULT and HORN. Discrete relays are optional. All relays are rated at 5 Amp for 28 VDC and 250 ~VAC RESISTIVE loads.



Appropriate diode (DC loads) or MOV (AC loads) snubber devices must be installed with inductive loads to prevent RFI noise spikes. Relay wiring should be kept separate from low level signal wiring.

## 1.2.4 Ambient Temperature Range

-25 to 50 degrees C

## 1.2.5 Humidity Range

0 TO 90% R. H. Non-Condensing.

## 1.2.6 Altitude

Recommended up to 2000 meters

## 1.2.7 Housings

- General purpose panel mount weighing 7 lbs and including hardware for 19" rack mounting ([Figure 6-1](#)).
- \*NEMA 4X wall mount in fiberglass enclosure weighing 17 lbs ([Figure 6-2](#)).
- \*NEMA 4X wall mount enclosure in 316 stainless steel weighing 30 lbs ([Figure 6-4](#)).
- \*NEMA 7 wall mount suitable for DIV 1&2 Groups B,C,D weighing 110 lbs ([Figure 6-5](#)).

\*Includes non-intrusive magnetic keypad.

## 1.2.8 Non-Intrusive Magnetic Keypad

The HA71 operator interface includes five front panel *touch* keys. A magnetic keypad option offers these five keys with adjacent magnetic keys. This option is included as a standard item when ordering NEMA 4X weather resistant or NEMA 7 explosion-proof enclosures. It is useful in applications where it may be inconvenient to open the enclosure's door to access the *touch* keypad.

## 1.2.9 Approvals

- CSA C22.2 No 1010.1 and ISA S82.02
- CSA C22.2 No 152 for combustibles
- UL 1604 / C22.2 No 213 (Div 2 Groups A,B,C,D)
- EN55011 & EN61000 (CE Mark).
- CSA File # = 219995 and may be seen at:  
[www.CSA-International.org](http://www.CSA-International.org).



---

## 2 Basic Operation



## 2.0 Basic Operation

The HA71 offers 3 graphic screens for viewing monitored data and a *Set-Up* menu screen for operator interface to configuration menus. They are shown below in Figure 2-1. The *Bar Graphs* screen allows viewing of all active channels simultaneously. The *Trend* screen displays a 24 hour trend one channel at a time. The *Combination* screen displays a bar graph, large engineering units and a 10 minute trend one channel at a time. Input channels may be displayed in sequence with the **UP/DOWN** keys. The **NEXT** key switches between the 3 graphic data screens. When HA71 power is applied, the graphic LCD returns to the screen active when power was last removed.

*Setup* menus are entered by pressing **EDIT** from any data screen, and scrolling to the desired menu using the **UP/DOWN** keys. Pressing **EDIT** again enters the selected menu's tree of variables. This *Setup* mode may be exited manually by pressing **NEXT**, or automatically when no keys are pressed for 5 minutes. Alarm relays and front panel alarm LED indicators remain active during the *Setup* mode. An **AUTHORIZE** menu offers a password feature to prevent tampering with HA71 parameters.

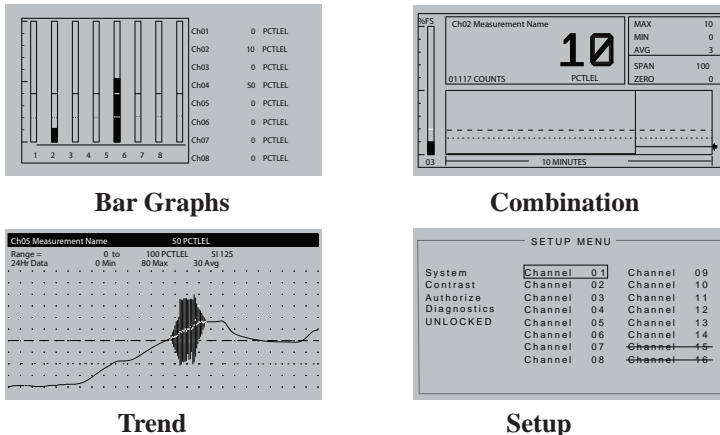

Figure 2-1. HA71 Graphic Screens

## 2.1 Setup Menu Configuration

Variables inside *system* and *channel* menu trees allow optimum HA71 configuration for a wide range of demanding multi-point monitoring applications. Access to menus is via the *Setup* mode by pressing **EDIT** and activating the *Setup* screen shown in Figure 2-1. Menu trees are provided for each of the 16 channels and another for system variables. Select the desired menu by scrolling with **UP/DOWN** and **EDIT** to enter the menus.

### 2.1.1 Changing Menu Variables Using the Keypad

Upon entering a menu, a pointer controlled by the **UP/DOWN** keys indicates the selected variable. Some are simple **YES/NO** or **ON/OFF** entries toggled by pressing the **EDIT** key. Others, such as *Measurement Name* and *Eunits* fields may have many ASCII character possibilities. Allowed ASCII characters are as follows:

ABCDEFGHIJKLMNOPQRSTUVWXYZ  
 abcdefghijklmnopqrstuvwxyz  
 BLANK SPACE  
 !"#\$%&`()\*+-./:;<=>?@  
 0123456789

**EDIT** places a cursor over the item and **UP/DOWN** scrolls through each allowed entry. The **NEXT** key moves the cursor to the next position within a field. When the field is complete, **EDIT** clears the cursor and loads it into non-volatile memory where it is retained indefinitely. With no cursor present, **NEXT** closes open menus in reverse order and returns the LCD to the most recent data display.

## 2.2 Channel Configuration Menus

Figure 2-2 illustrates the menu tree for configuring Channel variables. These items affect only the specific channel selected. System specific variables are in the menu tree shown in [Section 2.3](#).

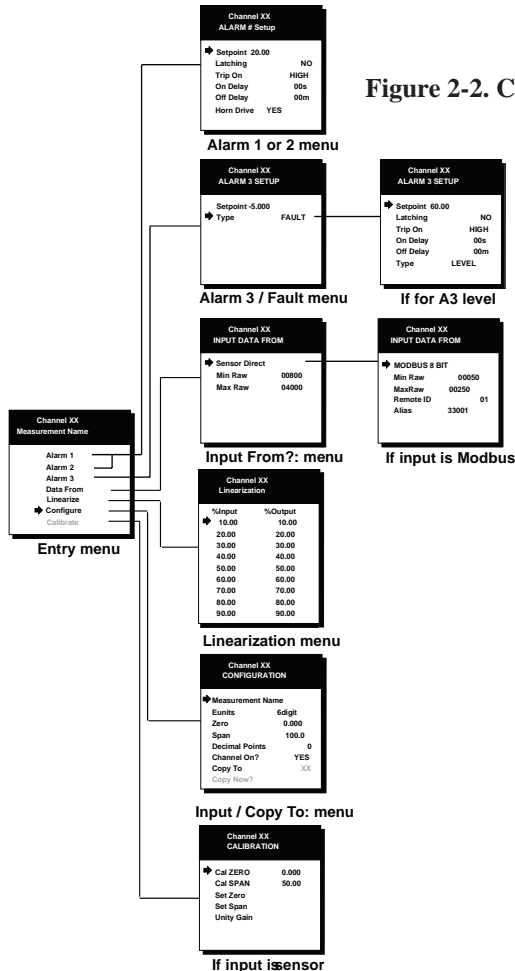

### 2.2.1 Channel Setup Entry Menu

The *entry menu* shown on the left side of Figure 2-2 allows access to all configuration variables for the selected channel. These are, **Alarm 1**, **Alarm 2**, **Alarm 3**, **Data From?** **Linearize**, **Input** and **Calibrate**.

### 2.2.2 Alarm 1 / Alarm 2 / Horn Relay Set-Up Menu

Alarms 1 and 2 are identical except A1 may not be *acknowledged* and front panel LED indicators are yellow while A2's are red. Since their configuration menus are the same only one is shown in Figure 2-3 for clarity.

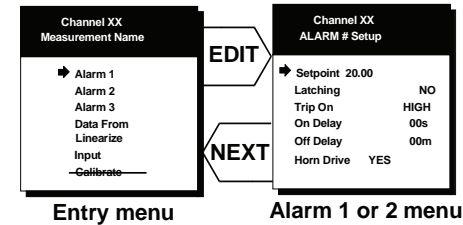

Figure 2-3. Alarm and Horn Relay Setup Menu

The first entry determines the **Setpoint** value where the alarm trips. It is entered in engineering units. For example, if a channel monitors 0-50 ppm H<sub>2</sub>S and the alarm must trip at 10 ppm, the correct entry is 10.00.

- Latching** determines either manual or automatic alarm reset operation. **YES** requires a manual **Alarm Reset** to unlatch the alarm even though an alarm condition no longer exists. **YES** also causes this alarm group's common relay, front panel LED, and optional discrete relay to latch. **NO** allows all outputs for this alarm to automatically reset as soon as the alarm condition clears.
- TRIP ON** is set to **HIGH** for increasing alarms or **LOW** for decreasing alarms to determine if the alarm activates upon exceeding or falling below the setpoint.

- The **ON DELAY / OFF DELAY** entries allow ON and OFF time delays affecting how long the setpoint must be surpassed before an alarm event transition occurs. **ON** delays are limited to 10 seconds while **OFF** delays may be as long as 120 minutes. Delays are useful in many applications to prevent nuisance alarms and unwanted cycling into and out of alarm conditions.
- The **HORN ON** entry allows linking this alarm to the common horn relay. **NO** causes the alarm to have no effect upon the horn relay. Entering **YES** causes this alarm to turn the horn relay on steady, or, to pulse it depending upon horn configuration in the system menu (see [Section 2.3.1](#)).

Discrete LED indicators on the front panel indicate the status of each alarm and relay. Any *new* alarm event causes the associated LED to flash until **Alarm Reset** occurs causing an *acknowledged* steady on condition. Operators should recognize *new* alarms by a flashing LED. **Alarm Reset** also *acknowledges*, or deactivates, the horn relay until another new alarm occurs.

## CAUTION

All relays are rated at 5 Amp for 28 VDC and 250 ~VAC **RESISTIVE** loads. **IMPORTANT:** Appropriate diode (DC loads) or MOV (AC loads) snubber devices must be installed with inductive loads to prevent RFI noise spikes. Relay wiring should be kept separate from low level signal wiring.

### 2.2.3 Alarm 3 / Fault Alarm Menu

The discrete channel alarms identified as Alarm 3/Fault may be configured either as a 3rd level alarm, or, as a Fault alarm indicating the input is out of range in the negative direction. When used as a level alarm, features such as on / off delays, latching, and trip direction are also available. It is important to understand that though discrete channel alarms (LED's & optional discrete relays) may be set as Alarm 3 level alarms, the common relay for this group is always a Fault alarm.

The fault *out of range* threshold for the channel is the most recent Fault trip point entered prior to changing the menu to Alarm 3. The following example describes how to configure both the Fault *out of range* and Alarm 3 *level* trip points for a channel.

**Example:** If the common Fault relay must trip as the input falls below negative 10% of full scale, and, the discrete alarms trip as the input exceeds a level, then the -10% Fault setpoint must be entered first. Toggle the **TYPE** menu entry to **FAULT** and enter -10.00% into the *setpoint* entry. Next, toggle the menu back to **LEVEL** and enter the desired Alarm 3 level *setpoint*. The Fault value is retained in memory even though it no longer appears on the menu.

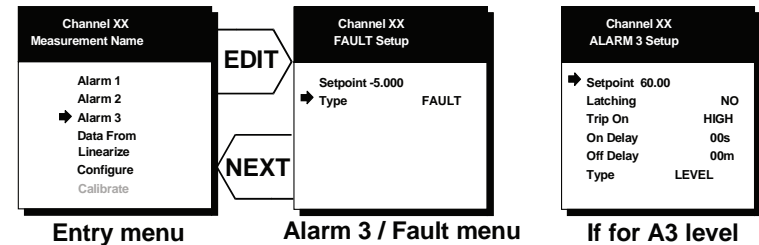

Figure 2-4. Alarm / Fault Alarm Menu

### 2.2.4 Data From? Menu to Set Input Source

Each channel may be independently configured to accept input data from the Modbus RS-485 master port or, from an analog input card attached to the I<sup>2</sup>C bus (see Figure 2-5). **EDIT** toggles the *Data From:* entry between *Modbus RTU, Analog, Analog with Local Cal or Sensor Direct*. There are eight different Modbus possibilities available to accommodate the binary resolution and format of the input data (see Figure 2-5). Each *Modbus* menu selection also requests the RTU # and the Alias register # location of the data to be retrieved from the RTU. Alias register numbers define the location of the variable representing the input value and must be obtained from the manufacturer of the Modbus RTU device.

*Analog* should be selected when the channel's input comes from a transmitter or monitoring device with a **calibrated** output such as 4-20mA. *Analog with Local Cal* is available when the HA71 will be the point of calibration for the analog input. *Sensor Direct* is identical to *Analog with Local Cal* and both activate the HA71's *Cal Mode* features (see [Section 2.2.14](#)). Problems may arise if calibrations are performed in two places upon the same signal so *Cal Mode* menus are only visible when *Sensor Direct* or *Analog with Local Cal* is selected. These selections should only be used when the input originates from a **non-calibrated** signal source such as the *Catalytic Bead Sensor Input* option described in section 3.1.3. This application requires the HA71 to be used as the calibration point since the sensors have no zero or span controls.

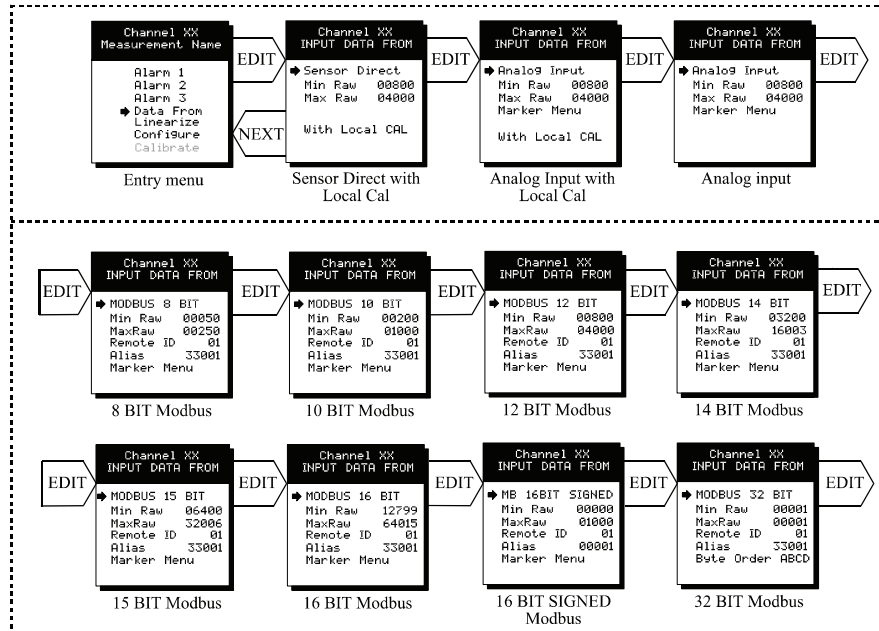

Figure 2-5. Data From? Menu

## 2.2.5 MIN/MAX Raw Counts Menu

The Min Raw and Max Raw counts entries included in the Input Data From: menu define the range of input counts that provide *Measurement Range* read out values described in [Section 2.2.10](#). This menu entry is determined by the A/D converter resolution of the channel's input. For example, if the input is a 10 bit Modbus® device with zero at 200 counts and 100% at 1000 counts, then this menu's MIN should be set at 200 and MAX at 1000. If communicating with the HA71's optional 12 bit Analog Input PCB the MIN should be 800 and the MAX 4000.

If the input device's resolution is unknown, the live counts variable on the bottom of the screen displays actual raw A/D counts currently being read by this channel. This reading may be used to test the input device for what A/D counts are provided for zero and 100% if these

values are unknown. Forcing the input device to read zero should provide the A/D counts value needed to make this channel's display also read zero. Likewise, forcing the input device to read 100% should provide the A/D counts value needed to make the HA71 channel's display also read 100%.

If Modbus® 32 BIT is selected, a Byte Order entry appears at the bottom of the menu. This determines WORD and BYTE alignment of data at the remote Modbus® transmitter when sending it's 4 byte IEEE Floating Point values. With the pointer on this entry, the EDIT key toggles between the 4 possible modes. Min / Max Raw values are not used in this mode.

12-Bit Analog Inputs may be direct from Sensor Input options or Voltage/Current Input options

The Modbus Master RS-485 port supports eight integer types, resolutions and formats.

### NOTE

Each Data From: item has a matching default MIN/MAX counts value of 20% to 100% with  $\pm 5\%$  over/underrange applied. If the default value is incorrect for the input device it should be edited.

## 2.2.6 Marker Menus

Some transmitters or monitoring devices providing HA71 inputs also indicate special modes of operation, such as *Calibration*, *Maintenance* or *Fault*, by transmitting a special <4mA or negative “Marker” value. The HA71 offers channel Marker menus for detecting and indicating such events (see Figure 2-6). While active, the HA71 displays a 6-digit ASCII message to indicate the special event and if equipped with 10-0167 4-20mA output option, the HA71 also transmits the same <4mA value.

- **Marker Enabled** turns the marker feature ON and OFF
- The negative Marker value is entered into the **Marker %** field as a negative percent of full scale. For example, -15.62% of full scale detects a marker value of 1.5mA (1.5mA is -15.62% of full scale when 4-20mA is the range).
- The **Mark As** menu allows user entry of the 6-digit ASCII message to be displayed when the marker is detected.

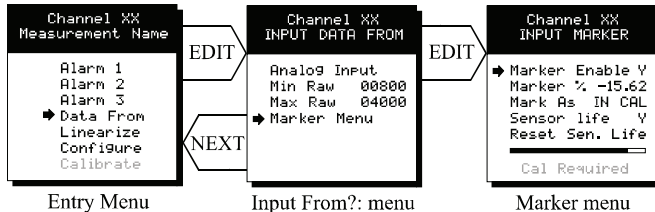

Figure 2-6. Marker Menus

## 2.2.7 Linearization Menu

The linearization menu allows each channel to have its own linearization curve stored in the controller’s non-volatile memory. Input versus output points must be entered in *percent of full scale values*. This means if the range is 0-200 ppm H<sub>2</sub>S then 100 ppm is 50% of full scale. Zero input will provide a zero output and 100% input a 100% output. Nine intermediate points may be entered to define the curve.

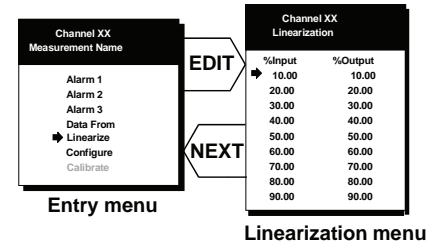

Figure 2-6. Linearization Menu

## 2.2.8 Configure Menu

From the entry level setup menu in Figure 2-7 the CONFIGURE menu may be entered for setting variables defining how the controller presents monitored data to the various graphic displays.

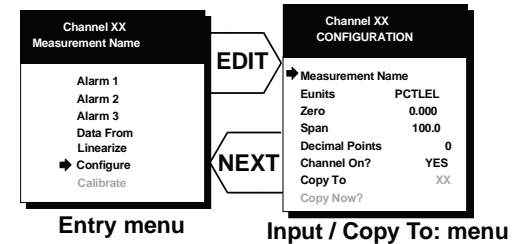

Figure 2-7. Configure Menu

## 2.2.9 Eunits / Measurement Name ASCII Data Fields

The first two items in this menu are for entering the 6 character *engineering unit* and 16 character *Measurement Name* ASCII fields. Eunits should define the units of measure for what this channel is to display. *Measurement Name* should describe the source of this data in the user’s terminology. [Section 2.1.1](#) of this manual describes how to use the front keypad to modify these fields.



## 2.2.10 Input Measurement Range

The **ZERO / SPAN** entries allow configuration of the measurement range displayed by this channel. Measurement Range works along with *A/D Counts* menus, described in [Section 2.2.5](#), to define the range of the input signal's engineering units. For example, if a channel's input is 4-20mA from a transmitter monitoring 0 to 10 ppm chlorine, then the **Zero** value should equal 0.000 and the **Span** value equal 10.00. The six ASCII engineering units previously entered are automatically displayed at the top of each menu as a reminder. Four digits must appear in this entry so trailing 0's may appear here that are not displayed on other data screens.

## 2.2.11 Decimal Point Resolution

Resolution of displayed channel values is configured in this menu by setting the number digits trailing the decimal point. Values are limited to a maximum of four digits, and a polarity sign. An auto-ranging feature displays the highest resolution allowed by this menu's decimal point entry. For example, if three decimal points are entered, and the range is 0 to 100 ppm, the reading will be **0.000** at 0 ppm and **100.0** at 100 ppm. However, this may be undesirable due to the high resolution at zero unless the sensor's output is extremely stable. If decimal points are limited to one, the 0 ppm reading becomes **0.0** and the 100 ppm reading remains **100.0**. Resolution may be limited further by setting decimal points to 0. In this example, this would cause 0 ppm to display **0** and 100 ppm to display **100**.

## 2.2.12 Turning off Unused Channels

The **Channel On?** entry determines if this channel is to be utilized. Turning it off will cause the controller to never process inputs applied to this channel and no alarms will be tripped or data displayed. Inactive channels have a line drawn through them on the Setup screen as indicated by channels 15 & 16 in [Figure 2-1](#). If less than 9 channels are

to be activated, the HA71 may be set for 8 channel mode, deactivating channels 9-16. This is done in the System Setup menu described in [Section 2.3](#). The HA71 will only allow 15 channels to be turned off; at least one channel must remain on.

## 2.2.13 Copy Data To?

This menu simplifies the Setup procedure by allowing similar channels to be copied from one to another. For example, if all channels are identical except for the *Measurement Name* entry, channel 1 could be configured and copied to channels 2 – 16. Only *Measurement Name* then must be configured on channels 2 – 16. Use **EDIT** to increment channel numbers and **UP/DN** to point to **Copy Now?** Press **EDIT** once more to copy.

## 2.2.14 CAL Mode



**Each channel's CALIBRATION menu is inactive unless its *Input Data From:* menu, described in [Section 2.2.4](#), is set for *Analog with Local Cal* or *Sensor Direct*. HA71 CAL MODE features allows pushbutton calibration of zero and span values. This feature should be utilized only when there are no other zero/span controls within the monitoring system since it is inappropriate to calibrate a signal at more than one point. Therefore, if calibration is to be performed at another transmitter or monitoring device, the HA71 CAL MODE feature should not be used.**

The CALIBRATION MENU allows entering the correct **Cal ZERO & Cal SPAN** setpoint values needed to calibrate the sensor. These are entered in the same engineering units as input range. **Set Zero & Set Span** controls in this menu allow pushbutton calibration by moving the pointer to each and pressing the **EDIT** key. A live reading of the channel's value allows calibration checks to see if an adjustment is needed. Unintentional calibrations are reset by the **Unity Gain** menu

item. **Unity Gain** resets zero offset to 0 and span gain to 1. It is useful for returning the calibration to a known starting place. Sensor aging may be monitored by recording zero and span readings at **Unity Gain** when it is new, and again at later dates when degradation may have occurred.

To check zero calibration, apply the ZERO calibration value to the sensor and observe the live reading. If the zero reading differs from the zero setpoint, a calibration is needed. To calibrate zero, move the pointer to **Set Zero** and press **EDIT**. A warning message explains that pressing **EDIT** again will change the zero calibration and any other key will exit. The procedure for span calibration is identical. For example, if an LEL combustible sensor is to be spanned with 50% LEL span gas, the span set-point must be 50%. If 45% LEL is to be used later, the span set-point must be changed to 45% to match the span calibration gas. If the reading is only 40% LEL with the 50% gas applied a span calibration is needed. Move the pointer to the **Set Span** entry and press **EDIT** twice. **Unity Gain** may be used at anytime to cancel incorrect calibrations and start again.

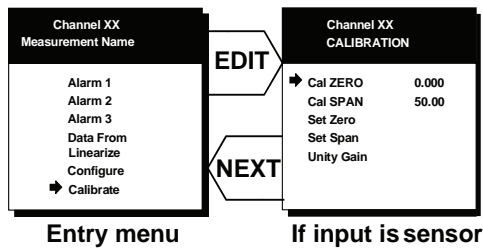

Figure 2-8. Calibration Menu

## 2.3 System Configuration Menus

Some items needing configuration are not specific to a channel but affect the entire HA71 system. These are located in the system entry menu shown on the left side of Figure 2-9. System menus are accessed by pointing to the desired item and pressing **EDIT**.

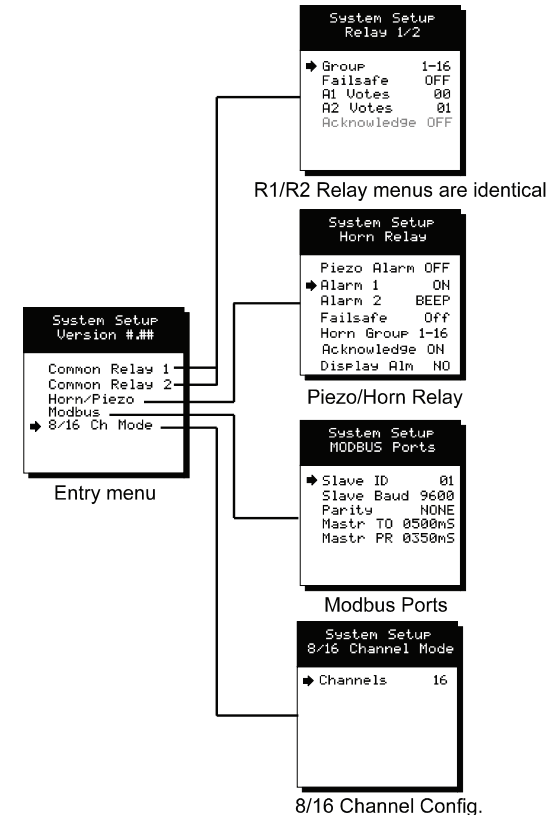

Figure 2-9. System Configuration Menus

## 2.3.1 Common Alarm Relays 1 and 2



### CAUTION

Read this section carefully and test all settings by simulating HA71 input conditions that should activate these alarm relays!

**Common Relay 1** and **Common Relay 2** menus are identical and therefore discussed only once. It is very important to fully understand these menus since they determine the functions of each common relay.

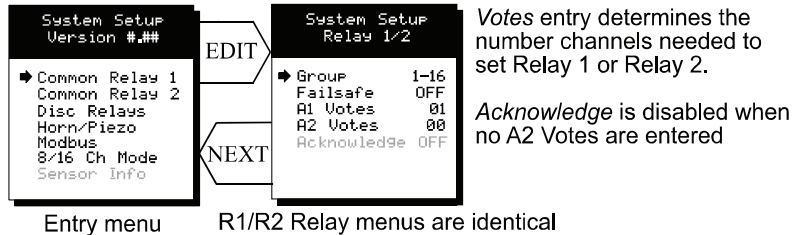

Figure 2-10. Common Relay 1 and Common Relay 2 Menu

- The **Group** menu entry offers additional flexibility by controlling which channels trip this menu's common alarm relay. The 3 choices are **1-16**, **1-8** or **9-16**. Some applications have different types of sensors, or, sensors in different areas connected to the same HA71 Controller. In these cases, it may be undesirable for a sensor on channel 9 to trip the same relay as a sensor on channel 2. The **Group** menu may restrict this. For example, channels 1-8 might be set to trip common relay 1 while channels 9-16 trip common relay 2. Another possibility is channels 1-8 be set to trip common relay 1 while channels 9-16 trip relays on an optional discrete relay PCB configured for Alarm 1 (see [Section 3.1.2](#)).
- Failsafe** controls relay activation for this common relay. **Failsafe ON** causes the relay to de-energize during alarm conditions

and energize when there is no alarm. Therefore a power failure forces the relay contact to the alarm position. Note the common Fault relay is always failsafe and may be monitored separately to indicate loss of power conditions in many applications.

- A1 and A2 Votes** allows creation of logical AND function equations that control common relay 1 & common relay 2. Default settings for common relay 1 are **A1 Votes = 01** and **A2 Votes = 00** which causes relay 1 to trip if any channel has an A1 level alarm active. Default settings for common relay 2 are **A1 Votes = 00** and **A2 Votes = 01** which causes relay 2 to trip if any channel has an A2 level alarm active. Example: If either default setting is modified such that **A1 Votes = 02** and **A2 Votes = 01**, then any two channels must have an A1 level alarm active and any one channel must have an A2 level alarm active to trip that relay.



### CAUTION

One of the A1's and the A2 could be on the same channel. These level alarms must come from a channel included in the Group entry described above.

- Turning **Acknowledge ON** (not available on Alarm 1) allows the common relay to be deactivated during alarm conditions by an **Alarm Reset**. This is useful if an audible device is being driven by the relay.



### CAUTION

All relays are rated at 5 Amp for 28 VDC and 250 ~VAC RESISTIVE loads. Appropriate diode (DC loads) or MOV (AC loads) snubber devices must be installed with inductive loads to prevent RFI noise spikes. Relay wiring should be kept separate from low level signal wiring.

## 2.3.2 10-0195 Discrete Relay “Failsafe” Mode

10-0195 Discrete relay options may also be configured to function in a *Failsafe* mode using the System Setup menu shown in Figure 2-11. Entering YES causes these discrete relays to have energized coils when no alarm condition exists for the associated channel and de-energized coils when the alarm occurs. *Failsafe* is useful for indicating failed relay coils and loss of power conditions.

### CAUTION

**10-0195 zoning jumpers (see [Figure 3-5](#)) should not be used when Discrete Relays menus are set for failsafe. Zoning jumpers cause ANY relay in the zone to energize ALL other relays in the same zone. Zoning of failsafe relays may be accomplished with wiring at the relay contact terminals.**

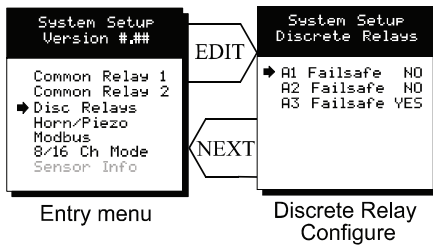

Figure 2.12. Failsafe Mode

## 2.3.3 Common Horn Relay and Local Piezo

The HA71 is equipped with a low decibel audible piezo which chirps when keys are pressed and may be configured to audibly indicate alarm conditions. The common horn relay is similar to the common A1 and A2 common relays.

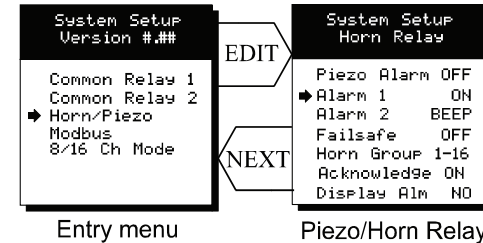

Figure 2-13. Common Horn Relay and Local Piezo Menu

- Turning **Piezo Alarm ON** causes the audible piezo to duplicate the action of the horn relay. This feature may be used to provide a low decibel indication of the status of the system’s horn.
- **Alarm 1 & Alarm 2** menus control how this alarm level from each channel will affect the common horn relay. Choices are **OFF**, **ON** or **BEEP** (one Hz. Pulsating). As an example, A2 conditions might pulse the horn (**BEEP**) and A1 conditions to cause a steady horn (**ON**). Any other combination of these 3 choices is possible for A1 and A2 levels affecting the horn relay. This feature is very useful since it allows the horn relay to serve as another level A1, level A2, or both; for channels 1-16, 1-8 or 9-16. Individual channel alarms may also be configured to not affect the Horn relay on a channel by channel basis (see [Section 2.2.2](#)).
- **Failsafe & Horn Group** menu entries are identical to the descriptions for menus **Common Relay 1** and **Common Relay 2** in [Section 2.3.1](#).
- Turning **Acknowledge OFF** allows the common Horn relay to drive devices other than horns or sirens such as a light or a fan.

- **Display Alm YES** forces the LCD to display the Bar Graphs screen upon any new alarm. This feature is offered to satisfy applications requiring channels in alarm to be displayed automatically (all channels are displayed on the Bar Graphs screen).

### 2.3.4 Modbus® Master / Slave Serial Port Menus

The system Modbus® menu allows setting RTU **Slave ID** address, **Slave Baud** rate and **Parity** for the comm2 *slave* Modbus® serial port (comm1 *master* port ID settings are per channel as described in [Section 2.2.4](#)). This slave port may be used to transfer HA71 data to a host device such as a PC, PLC, DCS or even another HA71. The slave port is addressable, allowing many HA71 controllers to be connected to a single RS-485 cable. [Section 5](#) of this manual provides important information describing how to interface to the HA71's Modbus® slave port.

The **Mastr TO** (master time out) and **Mastr PR** (master poll rate) menu items affect the HA71's *master* Modbus® port. *Time out* sets length of time in milliseconds before a communications error. Three consecutive timeout errors must occur before a communication error is indicated. This item is useful for optimizing throughput to the HA71 from other slave RTU's. *Poll Rate* sets frequency of data requests to the RTU's in milliseconds. This is useful when an RTU is limited in how fast it may respond to consecutive data requests.

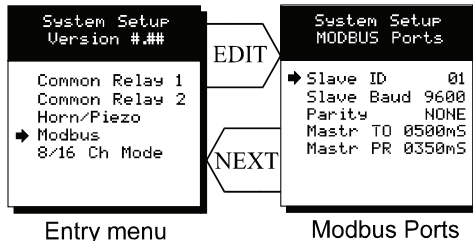

Figure 2-14. Modbus® Master/Slave Serial Port Menu

### 2.3.4 Eight / Sixteen Channel Modes

The final system menu allows setting the HA71 controller to accept either 8 or 16 channels. If 8 channels are selected by this menu they are channels 1-8 and 9-16 are disabled. One way HA71 cost is kept low is Input / Output option PCB's are arranged into groups of 8 channels. Therefore, users with less than 9 channels require only 1 PCB and do not pay for I/O hardware for 16 channels. If more than 8 channels are needed a second I/O option PCB may be required.

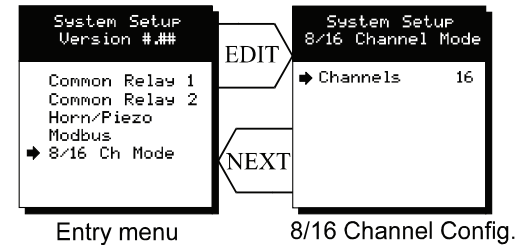

Figure 2-15. Eight/Sixteen Channel Mode Menu

## 2.4 Authorization Mode

A password entered in the **AUTHORIZATION** menu allows locking all menus. *Viewing* menus is not denied but attempts to *edit* variables flashes the **Locked** message on the LCD.

Authorized individuals locking the system should first enter a name, phone #, or other contact information into the 10 digit field. To lock or unlock the system the correct 4 digit authorization number must be entered into the **Enter Code** field. Point to the **Unlock System** entry and press **EDIT** to complete the unlock procedure. It is very important to remember the 4 digit code since the factory must be consulted if it is lost.

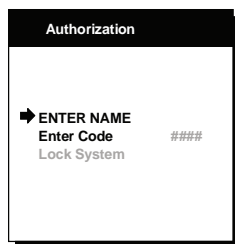

Figure 2-16. Authorization Mode Menu

## 2.5 LCD Contrast Adjustment

The Setup menu item identified as **CONTRAST** allows users to adjust the LCD contrast to a level suitable to the ambient lighting. Selecting **CONTRAST** and pressing **EDIT** causes the **UP/DOWN** keys to increase and decrease LCD contrast.



---

# 3 Main I/O Interface PCB



## 3.0 Main I/O Interface PCB

The most basic HA71 Controller requires only the I/O PCB shown in Figure 3-1 for interfacing to field wiring. The HA71 primary power supply is applied to terminals 9 and 11 of TB2. This may be from 10 – 30 VDC.

### WARNING

**HIGH VOLTAGES SUCH AS 115 VAC APPLIED TO THESE TERMINALS MAY CAUSE SEVERE DAMAGE! DC output terminals 10 and 12 on TB2 provide up to 500mA of output power for powering remote devices such as lamps, transmitters etc.**

This PCB includes both **master** (COMM 1) and **slave** (COMM 2) RS-485 Modbus® ports, 5 amp form C relays for each common alarm event (A1, A2, FAULT/A3 and HORN), and power supply I/O terminals. JP1 allows the RS-485 ports to be configured for 2 or 4 wire operation. A 26 pin ribbon cable connects the I/O PCB to the HA71 CPU and Display nest assembly. Two I<sup>2</sup>C bus connectors allow addition of optional functions such as analog I/O and discrete alarm relays for each channel.

Horizontal jumpers installed in JP1 connect the RS-485 port's RX and TX lines, simplifying 2 wire daisy chains by providing additional terminals for incoming and outgoing cables. For example, installing the 2 COM 1 jumpers connects screw terminals 1 and 5 and terminals 3 and 7. Socketed RS-485 terminating resistors R6 (COMM 1) and R12 (COMM 2) are located on the MAIN I/O board. These resistors should be removed if communication wire lengths are very short (less than 25 feet), or, if the port is not a the end of the communication line.

An optional Auxiliary Relays *piggyback* PCB (part # 10-0144) may be added to the I/O PCB via ribbon cable J4. These add another form C contact set to the common A1, A2 and HORN alarms. Auxiliary Relay contacts are available at the TB1 (AUX) terminals shown in Figure 3-1.

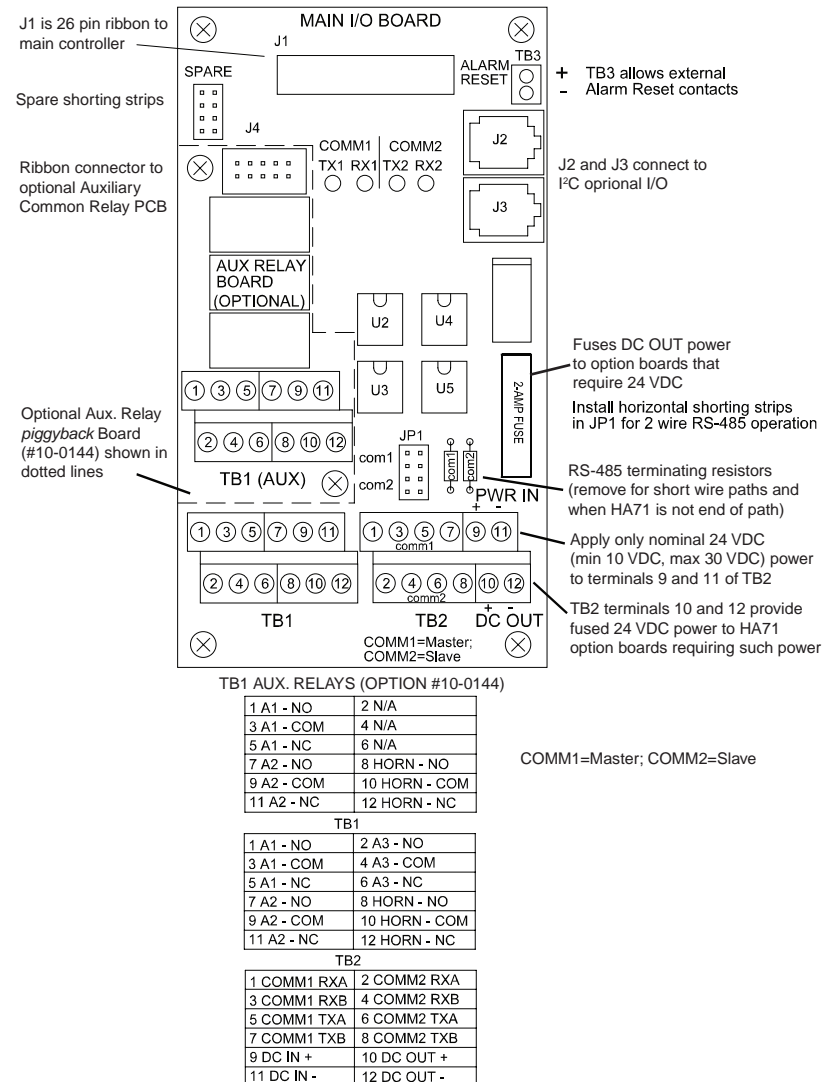

Figure 3-1. Main I/O Board with Common Relays

## 3.1 Input / Output Optional PCBs

Telephone style RJ11 connections are used to add optional 8 channel analog and digital I/O. A screen appears briefly after power up indicating what options are connected and for which channels. This information is also available from the *Diagnostics Mode* described in [Section 4](#).

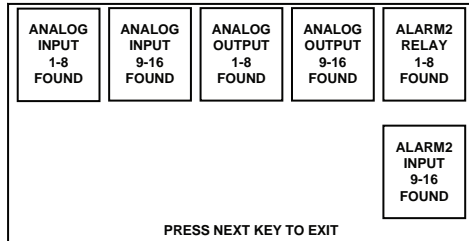

Figure 3-2. Optional PCB Display

### 3.1.1 Optional Analog Input PCB

Many transmitters or sensors have analog output signals and the 12 bit *Analog Input PCB*, shown in Figure 3-3, is available to accept these. TB1, with 24 positions, offers 3 terminals per channel for distributing power and receiving analog inputs. These are **EXC** and **HI / LO** inputs. TB2, with only two positions, is for connecting the power supply for powering external transmitters. Precision 100 ohm resistors (R1-R8) between each channel's **IN LO** and **IN HI** terminals are socketed termination resistors for 4-20mA inputs. These may be removed if voltage inputs are to be applied.

**EXC** and **IN LO** terminals are bussed together internally. **EXC** terminals are tied directly to TB2-1 (+) and **IN LO** terminals are tied to TB2-2 (-). Bussing allows transmitter power to be brought into the system at a single point (TB2) and distributed back out at each channel's **EXC** / **IN LO** terminals to simplify field wiring. Figure 3-3 includes typical wiring to 2 and 3 wire 4-20mA transmitters.

JP1 determines if the 8 analog inputs are applied to channels 1-8

or channels 9-16. Connecting more than 8 analog inputs requires 2 PCB's with one's JP1 set for channels 1-8 and the other set for channels 9-16.

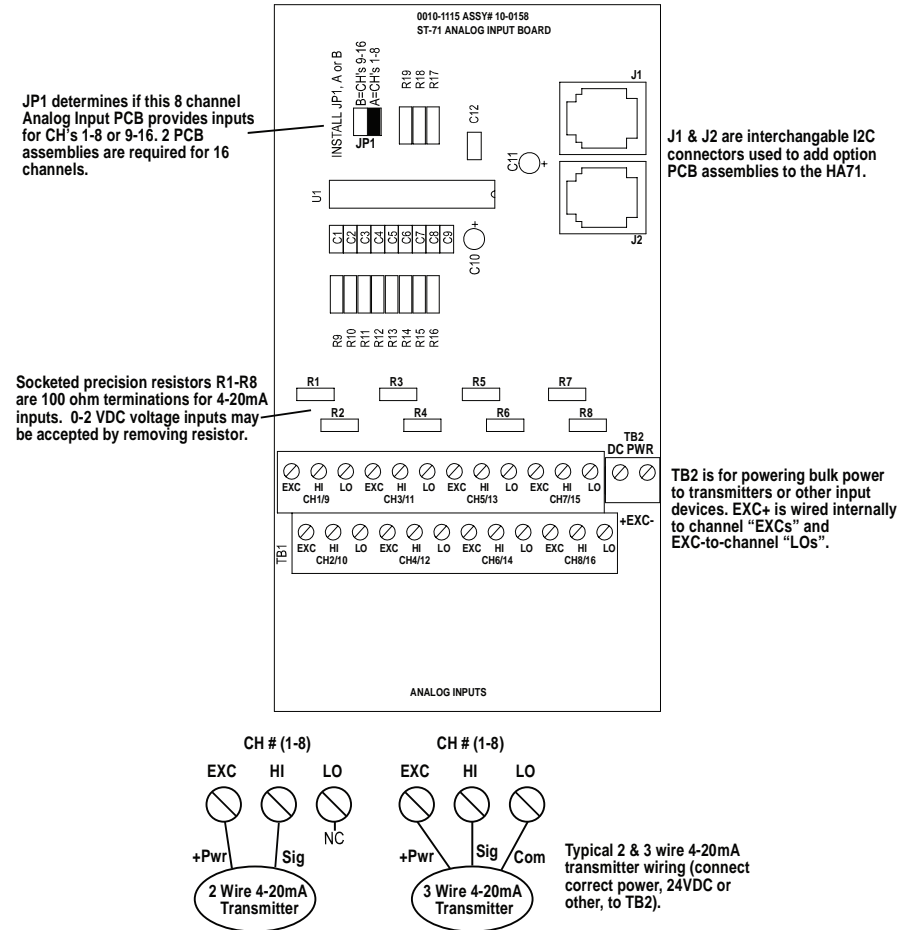

Figure 3-3. 8 Channel Analog Input Option 10-0158

## 3.1.2 Optional Discrete Relay PCB

An optional *Discrete Relay PCB*, shown in Figure 3-4, adds eight 5 amp (resistive) form C relays per sixteen channel alarm group (2 PCB's required when utilizing more than 8 channels). Each PCB may be configured via rotary switch S1 to function for ALARM 1, ALARM 2 or ALARM 3/FAULT for channels 1-8 or 9-16. A 1-minute time delay after power is provided to inhibit relay actuation until the system has had time stabilize. Alarm groups, or zones, may be created by connecting adjacent channels together using JP4 as shown. This creates a wire *OR* function with selected channels, causing *any* alarm included within the zone to actuate *ALL* zone relays. *Failsafe* operation of 10-0195 discrete relays is not allowed but may be programmed for the common relays in the *system* menu as described in [Section 2.3.2](#). Many HA71 applications utilize the common alarm relays (see [Section 3.0](#)) and do not require discrete relays for each of the 48 alarm events (16 A1's, 16 A2's & 16 A3's). If discrete relays are needed for all 48 alarms, then six PCB's are required.

5 VDC power to the discrete relay option PCB's is normally supplied from the HA71 Controller via the slender I<sup>2</sup>C cables connected to J2 and J3. However, I<sup>2</sup>C cables are limited in ability to carry this power further than a few feet without a significant voltage drop. Some HA71 applications with relays for all 48 alarms may require up to 6 boards. TB2 allows a heavier 5 VDC power cable to be connected from terminals on the back of the HA71 front panel assembly, bypassing the I<sup>2</sup>C cable. A 20 AWG pair connected to only one of the several TB2's is sufficient when these boards are in close proximity to each other.

### CAUTION

All relays are rated at 5 Amp for 28 VDC and 250 ~VAC RESISTIVE loads. Appropriate diode (DC loads) or MOV (AC loads) snubber devices must be installed with inductive loads to prevent RFI noise spikes. Relay wiring should be kept separate from low level signal wiring.

TB2 is used to supply external 5VDC power to Alarm boards when they are mounted > 5 feet from the controller. I<sup>2</sup>C cables provide 5VDC but losses occur with longer cable lengths.

WARNING: Voltages exceeding 6 volts may cause extensive damage to entire controller.

Standard configuration has a 1 minute POWER ON time delay preventing relay actuation during the delay. SB1 increases delay time to 8-minutes. SB2 removes all time delay.

S1 controls if discrete relays are tripped by A1, A2, or A3 alarms for Ch's 1-8 or 9-16. See Chart.

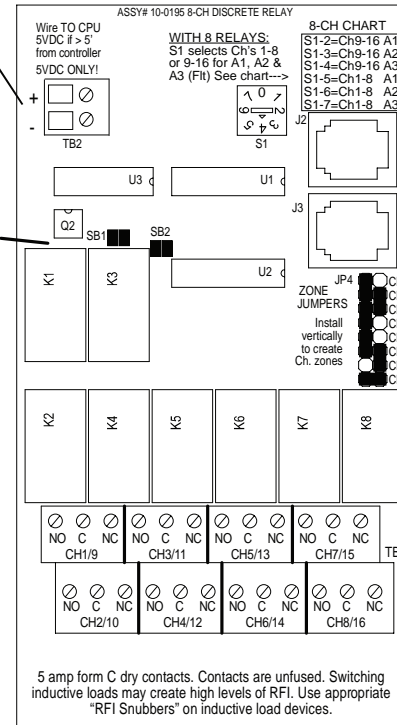

J2 & J3 are interchangeable I<sup>2</sup>C connectors used to add option PCB assemblies to the controller.

JP4 allows "zoning" of adjacent channel alarms. All zoning jumpers are placed vertically. Dwg. exhibits channels 1-4 and channels 5-7 creating 2 zones. All relays in a zone switch together. Unused jumpers may be stored horizontally.

Figure 3-4. 8 Channel Discrete Relay Option 10-0195

## 3.1.3 Optional \*Bridge Sensor Input Board

An optional 8-channel, 12 bit *Bridge Sensor* Input board allows these popular gas detectors to be connected directly to the HA71 without additional signal conditioning or transmitters. Up to four dual channel 10-0192 modules may be installed in each 8-channel 10-0191. Each 10-0192 channel is equipped with a bridge amplifier and balance potentiometer and an adjustable switching regulator for setting the correct sensor excitation voltage. A 3 position coarse gain jumper allows setting the gain of the bridge amplifier. Fault supervision circuitry forces the HA71 into a FAULT condition upon sensor failure or removal.

This option may also be configured to accept 4-20mA inputs for mixing bridge sensors and current loops into the same board. Placing any channel's 2 position LEL/4-20mA jumper into 4-20mA position and installing the associated precision 100 ohm socketed resistor allows 4-20mA signals to be applied to it's C and A terminals. The 10-0192 sensor modules are not required for channels accepting 4-20mA.

Channels receiving input data from this board should have the *Data From:* menu set for *Sensor*, as described in [Section 2.2.4](#). This activates *Cal Mode* menus described in [Section 2.2.13](#) needed to zero and span sensor readings. After performing the one time only *Initial Setup* as described below, all subsequent calibrations are by the HA71's electronic Cal Mode menus.

\*Catalytic sensors connected directly to the HA71 should be limited to ranges of 0-1000ppm.

## 3.1.4 Catalytic Bead Sensor Initial Setup

Catalytic bead sensors vary widely in power requirements and sensitivity. It is therefore important to configure each channel to match the sensor with which it will operate.

1. Prior to connecting sensors, apply power to the system.

### NOTE

This PCB requires 24VDC power be connected to its TB2 terminals 1 and 2 as shown in Figure 3-5. Suitable fused power is available from the Main I/O board's TB2 terminal 10 & 12 (see [Figure 3-1](#)). Measure the voltage between each channel's A and R terminals and set the Voltage Adjust potentiometers for the correct sensor excitation voltage. This may range from 1.5 volts to 7.5 volts depending upon sensor specifications.



### CAUTION

**Sensors may be damaged by accidental over voltage conditions. It is recommended the Voltage Adjust potentiometer screws be covered by a dollop of RTV or similar material after completion of this procedure to avoid accidental over voltage conditions.**

2. Remove system power and connect sensor wires to the R-C-A terminals. Reapply system power and confirm correct voltage across each sensor's A and R terminals.

### NOTE

If sensor wires are long, it may be necessary to measure the excitation voltage at the sensor end to compensate for I<sup>2</sup>R losses in the wiring.

3. With the minus voltmeter lead on TB2-2 (common), connect the plus lead to the channel's test point. With zero air on that sensor, adjust it's *Balance* potentiometer for .4 volts at the test point.
4. Apply 50% LEL combustible span gas to the sensor and allow the test point voltage to stabilize. Two volts = 100% input to the A – D Converter and .4 volts = 0%. Therefore, 1.2 volts = 50%. Place the 3 position *Coarse LEL Gain* jumper into the position which reads between .8 volts and 1.2 volts on the test point with 50% LEL gas on the sensor. Gain settings for each jumper position are as follows: no jumper = 1, LOW = 7, MED = 21, HI

# HA71 Digital Gas Controller

= 41. Multiple jumpers have an additive affect upon gain, so the LOW and MED jumpers together provide a gain of 28.

Initial setup is now complete and normally only requires repeating if a sensor is replaced. Final calibration of this channel may now be performed using the HA71's electronic Cal Mode feature described in [Section 2.2.1](#).

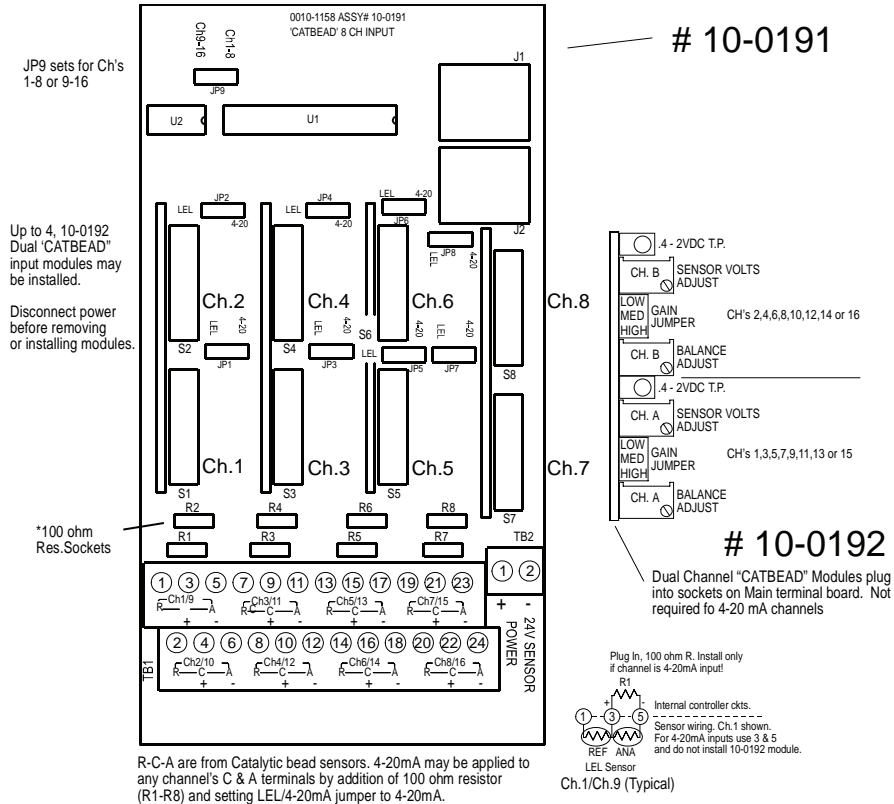

**Figure 3-5. 8 Channel "Catbead" Sensor Option 10-0191/10-0192**



## 3.1.5 Optional RTD / 4-20mA Analog Input Board

An optional 12 bit *RTD Sensor Input* board, shown in Figure 3-6, allows these popular temperature sensors to be connected directly to the HA71 without additional signal conditioning or transmitters. A 3 position range jumper allows setting the gain of the input bridge amplifier for the three popular ranges of 0-100°C, 0-200°C or 0-400°C. Other ranges are available by special order.

Inputs may also be configured to accept 4-20mA signals, allowing mixing RTD sensors and current loops into the same board. Two jumpers per channel determine either a RTD or 4-20mA input. These dual position jumpers, JP1 – JP16, must both be placed into the UP position for RTD inputs or both in the DOWN position for 4-20mA inputs (see Figure 3-5).

Channels receiving input data from this board should have the *Data From:* menu set for *Sensor*, as described in [Section 2.2.4](#). This activates *Cal Mode* menus, described in [Section 2.2.13](#), needed to perform *zero* and *span* calibrations of RTD sensor readings.

Each channel must be calibrated individually by either simulating desired zero and span calibration resistance values or by actually placing the channel's RTD into an actual precision temperature generator. Ice water is an acceptable method for generating the 0°C zero temperature value. Upscale span values are best simulated with an RTD calibrator. Since RTD's are stable and repeatable of over long time periods calibrations normally only need to be performed upon initial installation. Since the PCB has 8 channels, two are required for 16 channel applications. JP25 configures inputs for channel groups 1-8 or 9-16.

JP25 determines if this 8 channel RTD/mA input PCB accepts inputs for Ch's 1-8 or 9-16. 2 PCB assemblies are required for 16 channels

JP1-JP8 work with JP9-JP16 to determine if a channel accepts a resistive input or a 4-20mA input. JP17-Jp24 select 1 of 3 ranges for resistive inputs only.

Resistors R1-R8 are socketed 100 ohm terminating resistors for 4-20mA inputs and 100 ohm platinum RTDs (100 ohm for 0°C low range)

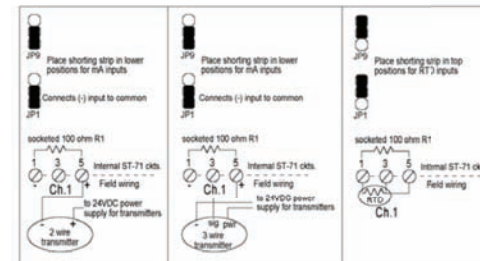
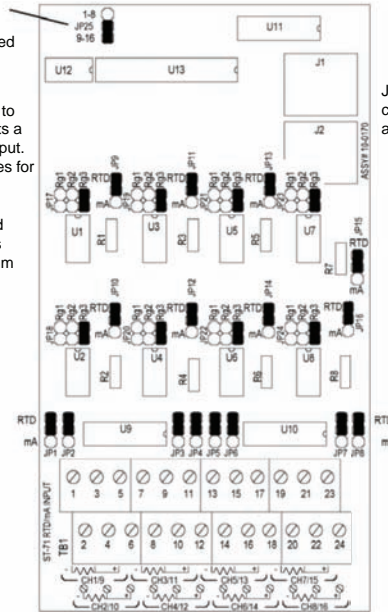

Input wiring options  
(Ch 1 shown; typical for all other ch)

Figure 3-6. 8 Channel Resistive/4-20mA Input Option 10-0170

## 3.1.6 Optional 4-20mA Analog Output Board

An optional 10 bit 4-20mA analog output board, shown in Figure 3-7, may be connected to the I<sup>2</sup>C bus. Each channel's output will transmit 4mA for 0% readings and 20mA for 100% readings. Loop drive capability depends upon the level of the HA71's primary DC power supply. With at least 20 volts DC primary power they are capable of driving 20mA through a 750 ohm load. Outputs are self powered and DC power should not be provided by the receiving device.

### NOTE

This PCB requires nominal 24VDC power be connected to TB2 terminals 1 & 2 as shown in Figure 3-6. Suitable power is available from the HA71 Main I/O board's TB2 terminal 10 & 12 (see [Figure 3-1](#)).

Since the PCB has 8 channels, two are required for 16 channel applications. JP1 configures the outputs for channels groups 1-8 or 9-16.

24 VDC power for output current loops must be supplied through TB2. Connect to main I/O PCB terminals 10 & 12 of TB2.

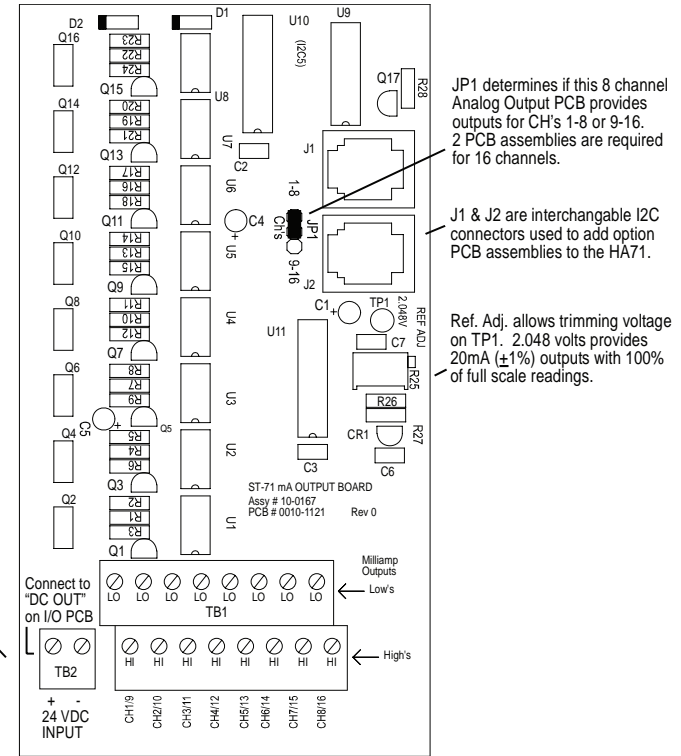

Figure 3-7. 8 Channel 4-20mA Output Option 10-0167

## 3.1.7 Optional Clock/Printer Interface Board

When equipped with the Clock / Printer Interface option, shown in Figure 3-8, the HA71 Controller is capable of automatically printing time & date stamped alarm events to a 24 PIN dot matrix printer such as the Panasonic KX-P1131. The cable interface between the HA71 and the KX-P1131 may be either parallel or serial. Parallel interfaces only allow 6 feet of separation while the RS-232 serial interface allows up to 50 feet. Distances up to 4000 feet may be obtained using the 10-0229 printer interface option's RS-422 port but requires an additional tri-port RS-422 / RS-232 converter at the printer end of the cable.

The 10-0229 Printer Interface may also be connected to a PC running HyperTerminal or other communications software as an alternative to hard copy printing of the data. Printer/PC cable schematics are shown in Figure 3-7. Printer settings for serial interfaces are 9600 baud, 8 data bits, no parity and one stop bit. Communications software settings are 9600 baud, 8 data bits, no parity, one stop bit and FlowControl = Hardware. Printer diagnostic red LED's indicate printer faults such as out of paper, overflowed buffer or loss of communications. Green LED's flicker to confirm good communications between the HA71 and printer during print attempts.

Examples of printed alarm events are shown below. The format of each event, from left to right, is DATE, TIME, 16 character ASCII channel ID from the HA71, HA71 channel #, alarm #, IN or OUT status.

05/22/03	08:21:00	Storage Tank 103	Chnl 1	Alarm 2	IN
05/22/03	08:21:01	Storage Tank 103	Chnl 1	Alarm 2	OUT
05/22/03	09:12:01	Storage Tank 103	Chnl 13	Alarm 1	IN
05/22/03	09:13:00	Fuel A Flow	Chnl 9	Alarm 1	IN
05/22/03	09:13:05	Storage Tank 103	Chnl 1	FAULT	IN
05/22/03	09:13:05	Fuel Dock	Chnl 2	FAULT	IN
05/22/03	09:40:10	Storage Tank 103	Chnl 13	Alarm 2	IN
05/22/03	09:40:14	Fuel Dock	Chnl 2	FAULT	OUT
05/22/03	09:40:14	Trans Pump 103	Chnl 3	FAULT	OUT
05/22/03	09:40:14	Storage Tank 103	Chnl 1	FAULT	OUT
05/22/03	11:53:37	Fuel A Flow	Chnl 9	Alarm 1	OUT

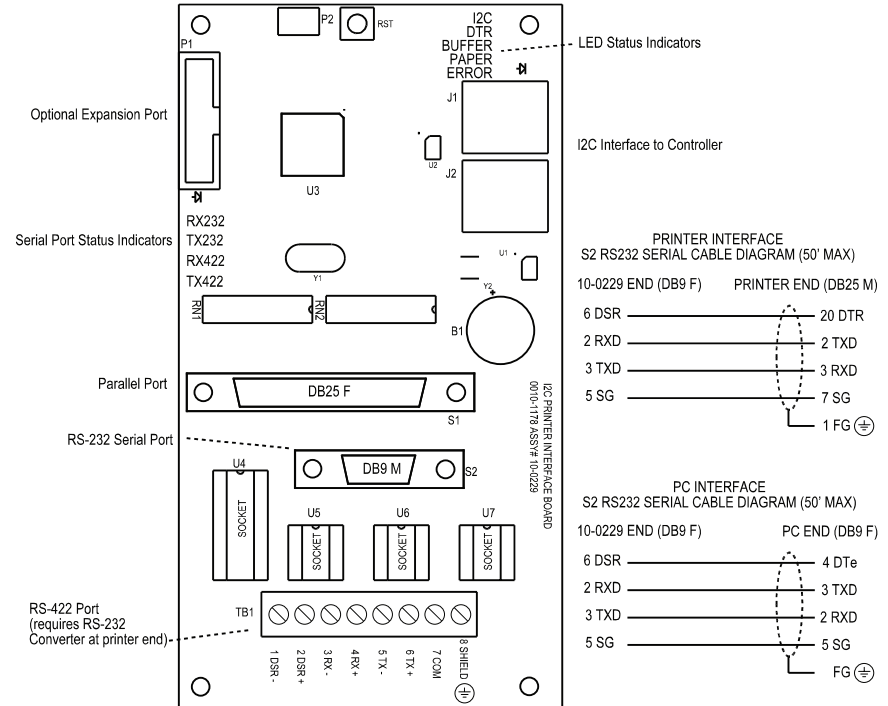

Figure 3-8. Printer Interface Option 10-0229

## 3.1.8 Clock / Printer System Set-Up Menu

Detection of the 10-0229 on the I<sup>2</sup>C bus causes the Clock/Printer System Setup menu item to appear. Selecting it and pressing EDIT brings up the menu shown below in Figure 3-9. **Date / Time** menu entries allow setting of correct local time and date. The **ALARM PRINT ON/OFF** entry allows printing to be discontinued if turned to OFF. **PORT** allows selection of either RS-232, RS-422 or the parallel port and only one port may be used at a time. **BUFFER DUMP** allows immediate printing of all the 30-35 stored events. **PRINT CONFIG** allows immediate printing of all channel variables such as channel ID's, Engineering Units etc. **PRINTER READY / ERROR** indicates the functional status of the printer.

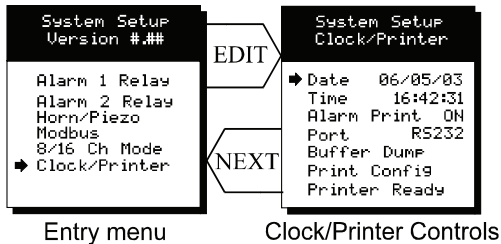

Figure 3-9. Clock/Printer Setup Menu

## 3.1.9 Optional 24VDC 150 Watt Power Supplies

The HA71 Controller may be powered from 10-30VDC. However, many applications require 24VDC power for the monitors or transmitters providing inputs to the HA71. A 150 watt AC / DC power supply may be included for these applications (115VAC or 230 VAC selected via slide switch). When ordered from the factory, it is pre-wired to provide 24VDC primary power for the HA71 controller as well as any transmitters or monitors that may be connected by the end user.



### SHOCK HAZARD

**Risk of electrical shock Disconnect or turn off power before servicing the equipment**

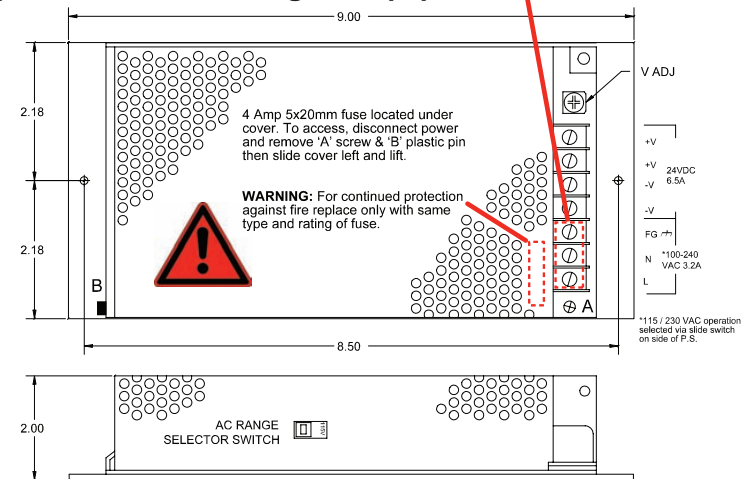

Figure 3-10. 150 Watt 24VDC Power Supply Options

---

# **4 System Diagnostics**

---

## 4.0 System Diagnostics

A *System Diagnostic Mode* shown in Figures 4-1 and 4-2 may be entered during normal operation from the Setup menu. The entry menu indicates firmware revision and offers useful routines for testing front panel LED's, relays, serial ports and analog I/O. It is exited manually by pressing **NEXT**, and automatically if no keys are pressed for 5 minutes.

### CAUTION

It is very important to understand that **CHANNEL INPUT DATA IS NOT PROCESSED DURING THE DIAGNOSTICS MODE**. It is possible to miss important input values while utilizing this mode and appropriate safeguards should be in place. However, the Diagnostics Mode can prove invaluable when testing I/O since relays and analog outputs may be stimulated without driving inputs to precise levels.



```
****WARNING****  
Inputs will not be processed  
while in diagnostics mode.  
Alarm Relay and Analog Outputs  
may change causing undesirable  
states affecting equipment  
connected to this controller.  
Press EDIT to enter diagnostics.  
Any other key to exit.
```

Press EDIT

```
*****  
*** ARE YOU SURE ***  
*****  
  
Press EDIT to enter diagnostics.  
Any other key to exit.
```

Press EDIT

```
Diagnostics  
Version X.XX  
Common Relays  
Discrete Relays  
Piezo  
Serial Ports  
Analog Outputs  
* Analog Inputs  
Alarm LEDs  
Printer Port  
Connected I/O
```

Diagnostics menu

Figure 4-1. System Diagnostic Mode (Part 1)



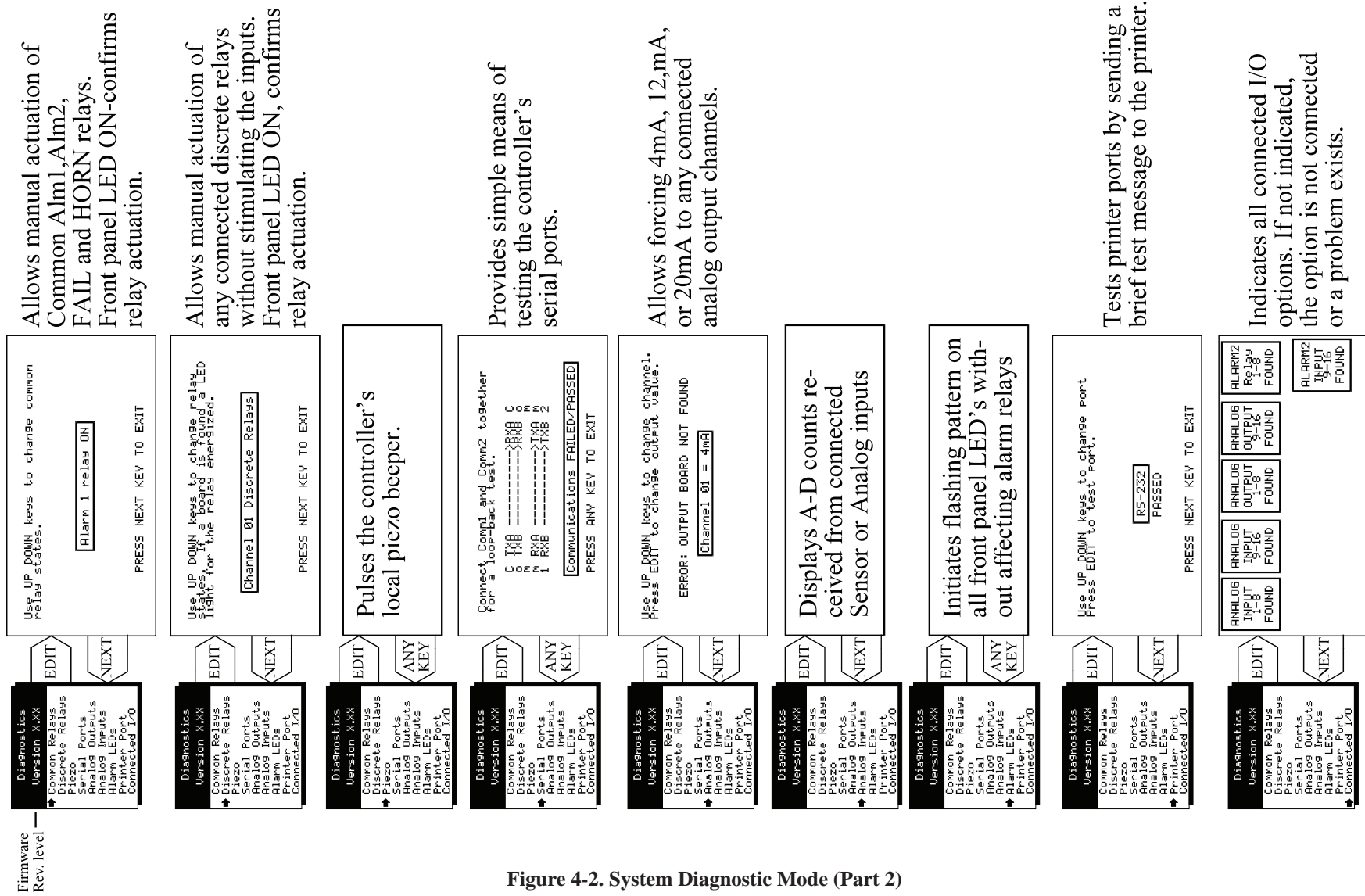

Allows manual actuation of Common Alm1,Alm2, FAIL and HORN relays. Front panel LED ON-confirms relay actuation.

Allows manual actuation of any connected discrete relays without stimulating the inputs. Front panel LED ON, confirms relay actuation.

Provides simple means of testing the controller's serial ports.

Allows forcing 4mA, 12, mA, or 20mA to any connected analog output channels.

Tests printer ports by sending a brief test message to the printer.

Indicates all connected I/O options. If not indicated, the option is not connected or a problem exists.

Figure 4-2. System Diagnostic Mode (Part 2)

---

**5 Modbus<sup>®</sup> RS-485 Ports**

## 5.0 Modbus® RS-485 Ports

The HA71 is equipped with Master (COMM 1), and Slave (COMM 2), Modbus® RTU ports. Port configurations are described in [Sections 2.2](#) and [2.3](#) of this manual. This section defines register locations of data available via the HA71 slave port.

### 5.1 Modbus® Slave Register Locations

The following table describes the HA71's Modbus® slave database. Any portion of this data may be read by a Modbus® master device such as a PC, PLC or DCS. Since the Modbus® port is RS-485, many HA71's may be multi-dropped onto the same cable.

Memory Integer ASCII:

Notes:

ASCII may be read 2 characters at a time or in strings using a multiple register read.

Sixteen character channel tag name:

Type	Channel	First	Last	Read FC	Write FC	Notes
Channel Tag	1	40401	40408	3	n/a	2 Characters per Register
Channel Tag	2	40409	40416	3	n/a	2 Characters per Register
Channel Tag	3	40417	40424	3	n/a	2 Characters per Register
Channel Tag	4	40425	40432	3	n/a	2 Characters per Register
Channel Tag	5	40433	40440	3	n/a	2 Characters per Register
Channel Tag	6	40441	40448	3	n/a	2 Characters per Register
Channel Tag	7	40449	40456	3	n/a	2 Characters per Register
Channel Tag	8	40457	40464	3	n/a	2 Characters per Register
Channel Tag	9	40465	40472	3	n/a	2 Characters per Register
Channel Tag	10	40473	40480	3	n/a	2 Characters per Register
Channel Tag	11	40481	40488	3	n/a	2 Characters per Register
Channel Tag	12	40489	40496	3	n/a	2 Characters per Register
Channel Tag	13	40497	40504	3	n/a	2 Characters per Register
Channel Tag	14	40505	40512	3	n/a	2 Characters per Register
Channel Tag	15	40513	40520	3	n/a	2 Characters per Register
Channel Tag	16	40521	40528	3	n/a	2 Characters per Register

Six character EUNITS tag:

Type	Channel	First	Last	Read FC	Write FC	Notes
EUNITS	1	40529	40531	3	n/a	2 Characters per Register; 3 Registers per Channel
EUNITS	2	40532	40534	3	n/a	2 Characters per Register; 3 Registers per Channel
EUNITS	3	40535	40537	3	n/a	2 Characters per Register; 3 Registers per Channel
EUNITS	4	40538	40540	3	n/a	2 Characters per Register; 3 Registers per Channel
EUNITS	5	40541	40543	3	n/a	2 Characters per Register; 3 Registers per Channel
EUNITS	6	40544	40546	3	n/a	2 Characters per Register; 3 Registers per Channel
EUNITS	7	40547	40549	3	n/a	2 Characters per Register; 3 Registers per Channel
EUNITS	8	40550	40552	3	n/a	2 Characters per Register; 3 Registers per Channel
EUNITS	9	40553	40555	3	n/a	2 Characters per Register; 3 Registers per Channel
EUNITS	10	40556	40558	3	n/a	2 Characters per Register; 3 Registers per Channel
EUNITS	11	40559	40561	3	n/a	2 Characters per Register; 3 Registers per Channel
EUNITS	12	40562	40564	3	n/a	2 Characters per Register; 3 Registers per Channel
EUNITS	13	40565	40567	3	n/a	2 Characters per Register; 3 Registers per Channel
EUNITS	14	40568	40570	3	n/a	2 Characters per Register; 3 Registers per Channel
EUNITS	15	40571	40573	3	n/a	2 Characters per Register; 3 Registers per Channel
EUNITS	16	40574	40576	3	n/a	2 Characters per Register; 3 Registers per Channel

Six character Value ASCII string:

Type	Channel	First	Last	Read FC	Write FC	Notes
ASCII Value	1	40577	40579	3	n/a	2 Characters per Register; 3 Registers per Channel
ASCII Value	2	40580	40582	3	n/a	2 Characters per Register; 3 Registers per Channel
ASCII Value	3	40583	40585	3	n/a	2 Characters per Register; 3 Registers per Channel
ASCII Value	4	40586	40588	3	n/a	2 Characters per Register; 3 Registers per Channel
ASCII Value	5	40589	40591	3	n/a	2 Characters per Register; 3 Registers per Channel
ASCII Value	6	40592	40594	3	n/a	2 Characters per Register; 3 Registers per Channel
ASCII Value	7	40595	40597	3	n/a	2 Characters per Register; 3 Registers per Channel
ASCII Value	8	40598	40600	3	n/a	2 Characters per Register; 3 Registers per Channel
ASCII Value	9	40601	40603	3	n/a	2 Characters per Register; 3 Registers per Channel
ASCII Value	10	40604	40606	3	n/a	2 Characters per Register; 3 Registers per Channel
ASCII Value	11	40607	40609	3	n/a	2 Characters per Register; 3 Registers per Channel
ASCII Value	12	40610	40612	3	n/a	2 Characters per Register; 3 Registers per Channel
ASCII Value	13	40613	40615	3	n/a	2 Characters per Register; 3 Registers per Channel
ASCII Value	14	40616	40618	3	n/a	2 Characters per Register; 3 Registers per Channel
ASCII Value	15	40619	40621	3	n/a	2 Characters per Register; 3 Registers per Channel
ASCII Value	16	40622	40624	3	n/a	2 Characters per Register; 3 Registers per Channel

Memory Floating Point:

Notes:

Returned as 15 bit 2s complement with +- 5% over/underrange applied.. Therefore this must be considered when scaling values to be displayed at the Workstation. The following equation may be used to determine a value for display.

$$\text{Display Value} = \frac{\text{Modbus}^{\text{®}} \text{ Value } [ (\text{Span Value} - \text{Zero Value}) 1.1 ] + \{ \text{Zero Value} - [ (\text{Span Value} - \text{Zero Value}) .05 ] \}}{32767}$$

Type	Channel	First	Last	Read FC	Write FC	Notes
Channel Value	1-16	33001-16	n/a	4	n/a	15bit 2s complement w/+ - 5% over/underrange

Analog Output:

Notes:

12 bit integer for Channel Reading value = 800 counts = zero value, 4000 counts = 100% value.

Type	Channel	First	Last	Read FC	Write FC	Notes
Channel Reading	1-16	31001	31016	4	n/a	12bit integer

Channel Status words contain configuration and status bits for a channel. They are as follows:

Type	Channel	First	Last	Read FC	Write FC	Notes
Channel Status	1-16	31017	31032	4	n/a	16bit integer (see bit by bit definition below)

Bit by Bit Definition:

Alarm 1 Trip	bit0	1 = Low	0 = High
Alarm 1 Horn Drive	bit1	1 = On	0 = Off
Alarm 3 Type	bit2	1 = Level	0 = Fault
Alarm 2 Horn Drive	bit3	1 = On	0 = Off
Linearize	bit4	1 = On	0 = Off
Alarm 3 Trip	bit5	1 = Low	0 = High
Input <i>In Cal</i>	bit6	1 = 1.5mA Cal Detected	0 = Normal Mode
Channel Disable	bit7	1 = Disabled	0 = Enabled
Controller Channel <i>In Cal</i>	bit8	1 = Cal Mode	0 = Normal Mode
Modbus® Data Type	bit9	1 = 4 byte float	0 = 2 byte integer
reserved	bit10		
reserved	bit11		
Alarm 1 Latch	bit12	1 = Latching	0 = Non latching
Alarm 2 Latch	bit13	1 = Latching	0 = Non latching
Alarm 3 Latch	bit14	1 = Latching	0 = Non latching
Alarm 2 Trip	bit15	1 = Low	0 = High



Alarm status words are bits packed into 16 bit integer where lsb = channel 1 alarm status and msb = channel 16 alarm status.

Alarm status (bit = 1 indicates alarm is active):

Type	Channel	First	Last	Read FC	Write FC	Notes
Alarm 1 Status	1-16	31033	n/a	4	n/a	packed 16bit integer
Alarm 2 Status	1-16	31034	n/a	4	n/a	packed 16bit integer
Alarm 3 Status	1-16	31035	n/a	4	n/a	packed 16bit integer
*Relay Status	n/a	31036	n/a	4	n/a	packed 16bit integer

\*Note:

Common Relay status bits (register 31036) are as follows.

Relay 1= bit0.

Relay 2= bit1

Fault Relay = bit2

Horn Relay = bit3

Alarm LED flashing status (bit = 1 indicates LED is flashing; “Acknowledge” clears all to 0):

Type	Channel	First	Last	Read FC	Write FC	Notes
Alarm 1 Status	1-16	31049	n/a	4	n/a	packed 16bit integer
Alarm 2 Status	1-16	31050	n/a	4	n/a	packed 16bit integer
Alarm 3 Status	1-16	31051	n/a	4	n/a	packed 16bit integer

LCD Display Screen Displayed Integer:

Type	Channel	First	Last	Read FC	Write FC	Notes
LCD Screen	n/a	31053	n/a	4	n/a	8bit integer

Coils:

Notes:

Set this coil to issue an alarm “Acknowledge” via Modbus®.

Type	Channel	First	Last	Read FC	Write FC	Notes
Alarm Reset	n/a	2001	n/a	n/a	5	write 0xff to high byte to set

## Memory Discretes:

### Notes:

May be read as single discrete or packed with multiple register read.

Type	Channel	First	Last	Read FC	Write FC	Notes
Channel Alarm 1	1-16	12001-16	n/a	2	n/a	discrete, may be packed

Type	Channel	First	Last	Read FC	Write FC	Notes
Chnl Alarm 2	1-16	12017-32	n/a	2	n/a	discrete, may be packed

Type	Channel	First	Last	Read FC	Write FC	Notes
Chnl Alarm 3	1-16	12033-48	n/a	2	n/a	discrete, may be packed

## Memory Reals:

### Notes:

Real value represents float value without the decimal point such as 123.4 is returned as 1234.

Decimal divisor is returned as 1, 10, 100, or 1000 for decimal position of 1, 2, 3, or 4, where 123.4 would return the value 10.

Type	Channel	First	Last	Read FC	Write FC	Notes
Zero Real	1-16	41001-16	n/a	4	n/a	zero real w/o decimal point
Zero DP	1-16	41017-32	n/a	4	n/a	zero real divisor
Span Real	1-16	41033-48	n/a	4	n/a	span real w/o decimal point
Span DP	1-16	41049-64	n/a	4	n/a	span real divisor
Alarm 1 Real	1-16	41065-80	n/a	4	n/a	alarm 1 real w/o decimal point
Alarm 1 DP	1-16	41081-96	n/a	4	n/a	alarm 1 real divisor
Alarm 2 Real	1-16	41097-112	n/a	4	n/a	alarm 2 real w/o decimal point
Alarm 2 DP	1-16	41113-28	n/a	4	n/a	alarm 2 real divisor
Alarm 3 Real	1-16	41129-44	n/a	4	n/a	alarm 3 real w/o decimal point
Alarm 3 DP	1-16	41145-60	n/a	4	n/a	alarm 3 real divisor
Fault Real	1-16	41161-76	n/a	4	n/a	alarm 3 real w/o decimal point
Fault DP	1-16	41177-92	n/a	4	n/a	alarm 3 real divisor

## 24 Hour Trend Database:

The 24 hour MAX, MIN and AVERAGE trend data may be retrieved over the Modbus® serial interface. Each channel consists of 240 MAX, MIN and AVERAGE values, or, one value for every 1/10 hour (6 minutes). Since there are 16 channels this database equals 3,840 registers in addresses 33017-36857. Due to the large size, MAX, MIN or AVERAGE values may only be retrieved one at a time. To improve bandwidth the master may retrieve the database in blocks of 120 registers at a time (one half of a channel's data). The C1 only updates these 3,840 registers upon receiving an update command from the Modbus® master.

Type	Channel	First	Last	Read FC	Write FC	Notes
Update MIN	n/a	2065	n/a	n/a	5	Moves 24 hour MIN data trend to trend data base
Update AVG.	n/a	2066	n/a	n/a	5	Moves 24 hour MIN data trend to trend data base
Update MAX	n/a	2067	n/a	n/a	5	Moves 24 hour AVG data trend to trend data base

This update requires several seconds. Therefore, a data ready register is available to notify the master upon completion.

Type	Channel	First	Last	Read FC	Write FC	Notes
MIN Ready	n/a	12065	n/a	2	n/a	0 = data ready; 1 = update in progress
AVG. Ready	n/a	12066	n/a	2	n/a	0 = data ready; 1 = update in progress
MAX Ready	n/a	12067	n/a	2	n/a	0 = data ready; 1 = update in progress

## Trend database registers

Type	Channel	First	Last	Read FC	Write FC	Notes
24 hr Trend	1-16	33017	36857	5	n/a	Transfers 24 hour trend for MAX, MIN or AVG.

---

**6 HA71 Enclosures**

---

## 6.0 HA71 Enclosures

### 6.1 HA71PM Panel / Rack Mount Enclosure

The HA71PM shown in Figure 6-1 is a half width 19" rack enclosure. It is supplied with hardware that allows mounting in either a full width 19" rack style cabinet or it may be panel mounted in a rectangular cutout. Only two 8 channel I/O option PCB's such as analog input or discrete relays may be mounted directly to the back of the enclosure. Additional 8 channel I/O option PCB's must be located external from the assembly on another mounting plate. A 3 foot length of I<sup>2</sup>C cable is also supplied for this purpose. Weight is approximately 7 pounds. Properly ground the enclosure and follow national and local electrical codes.

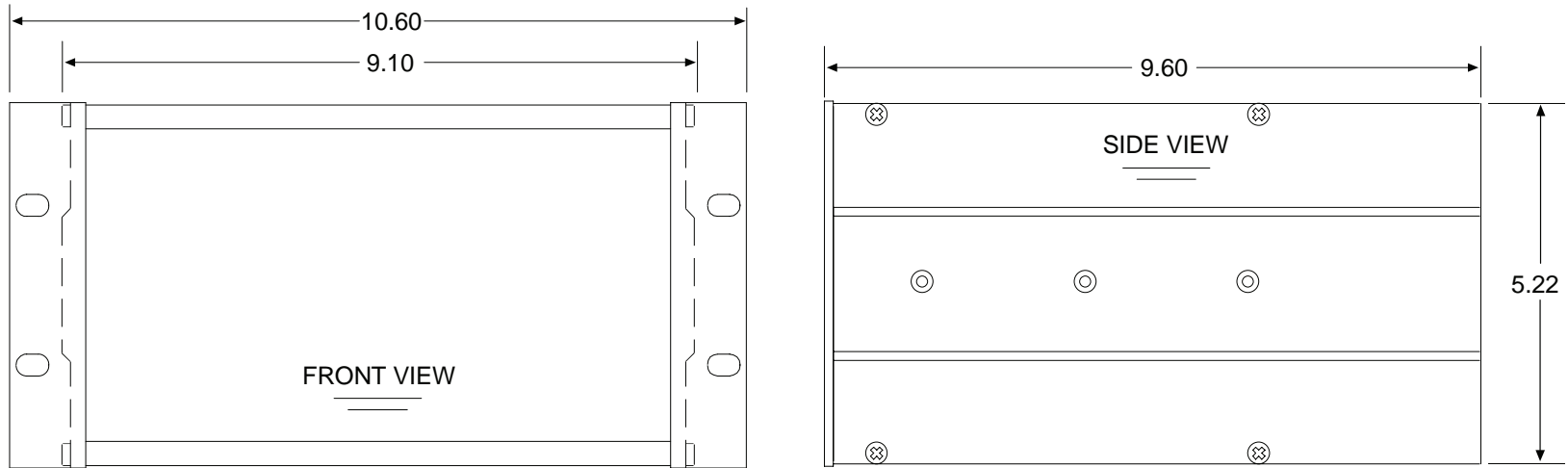

Note: Panel cut-out = 5.25 X 9.20

**RACK / PANEL MOUNT**  
(19" RACK SPREADER PLATES &  
PANEL MOUNT BEZEL NOT SHOWN)

**Figure 6-1. Rack/Panel Mount**

## 6.2 HA71N4 NEMA 4X Fiberglass Wall Mount Enclosure

The HA71N4 shown in Figure 6-2 is a fiberglass NEMA 4X wall mount enclosure. Seven, 8 channel I/O option PCB's, such as analog input or discrete relays, may be mounted inside this enclosure. It is suitable for mounting outdoors but an above mounted weather deflector shield is recommended. Weight is approximately 17 pounds. Figure 6-3 provides important warning information concerning correct grounding procedures for non-metallic enclosures. Conduit entries are not provided so installers may place entries as needed. Bottom or lower side areas are recommended. Care must be taken to avoid drilling into circuit boards mounted inside the enclosure. Properly ground the enclosure and follow national and local electrical codes.

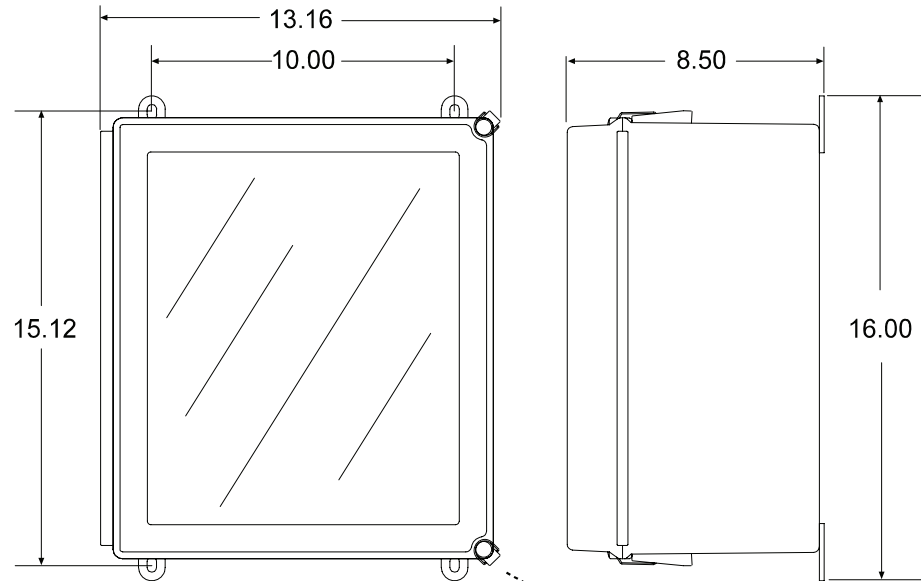

Note: 4 mounting holes are .31 diameter

### SHOCK HAZARD

ADD LOCKING DEVICE TO CLASP ON BOTTOM RIGHT SIDE TO PREVENT CONTACT WITH DANGEROUS VOLTAGES. REMOVE AC POWER BEFORE SERVICING EQUIPMENT.



Figure 6-2. NEMA 4X Wall Mount





## GROUNDING OF EQUIPMENT AND CONDUIT

Ground in accordance with the requirements of the National Electrical Code.

Conduit hubs for metallic conduit must have a grounding bushing attached to the hub on the inside of the enclosure. Grounding bushings have provisions for connection of a grounding wire. Non-metallic conduit and hubs require the use of a grounding wire in the conduit. Grounding bushings are not required.

System grounding is provided by connection wires from all conduit entries to the subpanel or to other suitable point which provides continuity. Any device having a metal portion or portions extending out of the enclosure must also be properly grounded.

## TYPICAL GROUNDING ILLUSTRATIONS

### METALLIC CONDUIT

### NON-METALLIC CONDUIT

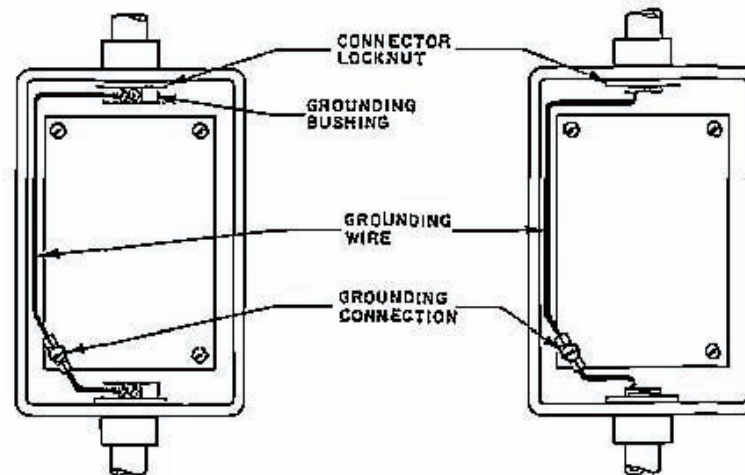

Figure 6-3. Grounding Illustration

## 6.3 HA71SS NEMA 4X 316 Stainless Steel Wall Mount Enclosure

The HA71SS shown in Figure 6-4 is a 316 stainless steel NEMA 4X wall mount enclosure. Seven, 8 channel I/O option PCB's, such as analog input or discrete relays, may be mounted inside this enclosure. It is suitable for mounting outdoors but an above mounted weather deflector shield is recommended. Weight is approximately 30 pounds. Conduit entries are not provided so installers may place entries as needed. Bottom or lower side areas are recommended. Care must be taken to avoid drilling into circuit boards mounted inside the enclosure. Properly ground the enclosure and follow national and local electrical codes.

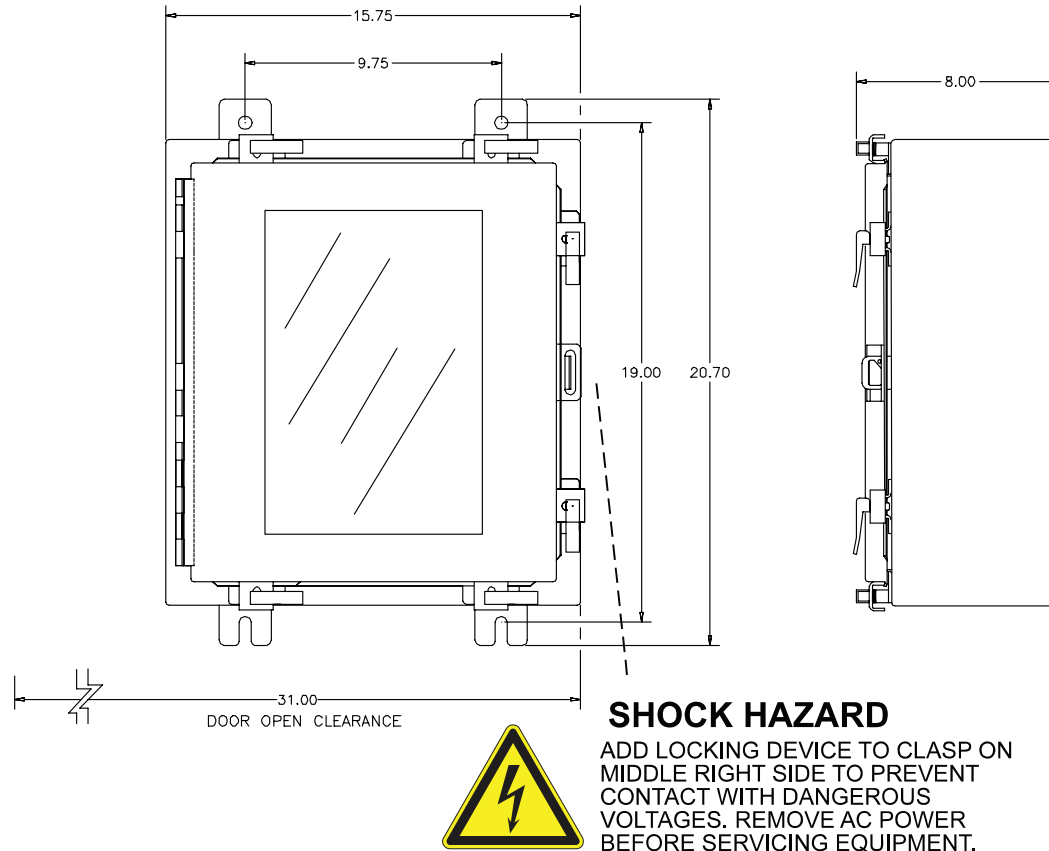

Figure 6-4. Stainless Steel NEMA 4X Wall Mount

## 6.4 HA71XP NEMA 7 Explosion-Proof Wall Mount Enclosure

The HA71XP shown in Figure 6-5 is an aluminum NEMA 4X/7 wall mount enclosure designed for mounting into DIV 1 and 2 Groups B,C,D potentially hazardous areas. Eleven, 8 channel I/O option PCB's, such as analog inputs or discrete relays, may be mounted inside this enclosure. It is suitable for mounting outdoors but an above mounted weather deflector shield is recommended. Weight is approximately 110 pounds. Properly ground the enclosure and follow national and local electrical codes.

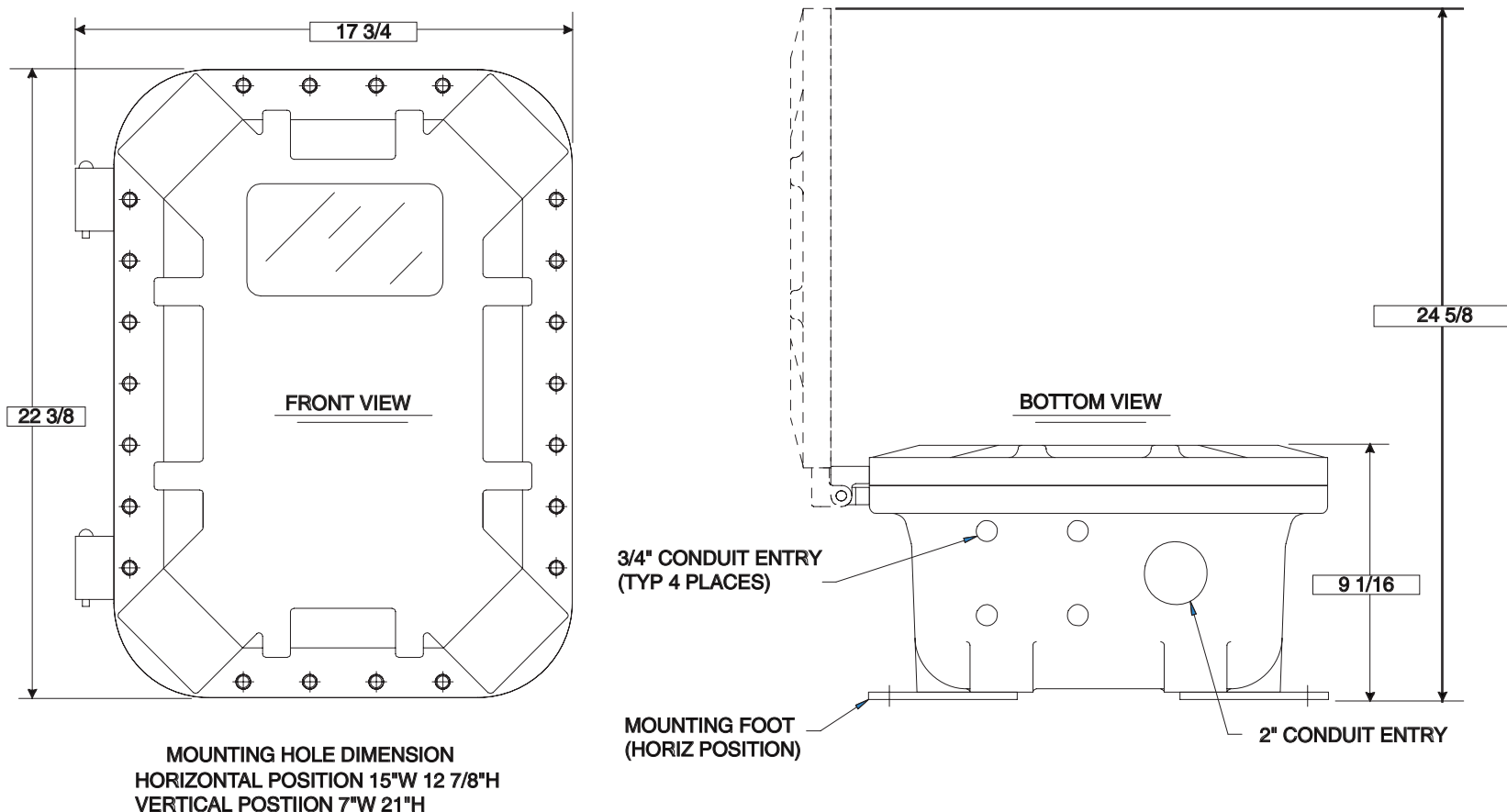

Figure 6-5. HA71XP NEMA 7 Explosion Proof Wall Mount Enclosure

## 6.5 HA71 Main I/O and Option PCB Footprint Dimensions

HA71 controllers have virtually unlimited possibilities for configuration of options such as analog I/O, discrete relays, printer interface and others. All HA71 enclosure styles require the Main I/O PCB ([Figure 3-1](#)) but also support the mounting of additional option PCB's as described below:

- HA71PM Panel/Rack Mount supports 2 option positions as standard and 4 more with the 10-0180 expansion plate (since in panel / rack mount installations 10-0180's must be mounted in user space behind panels or inside racks, multiple 10-0180's may be incorporated to support the required option positions).
- HA71N4 NEMA 4X Wall Mount supports 3 option positions as standard and 4 more with the 10-0180 expansion plate. If more than 7 option positions are required the 10-0178 NEMA 4X wall mount option enclosure supporting 8 positions may be added.
- HA71XP NEMA 7 Wall Mount supports 5 option positions as standard and 3 more with the 10-0181 expansion plate.

Diagram 6-6 provides Main I/O and option PCB dimensions.

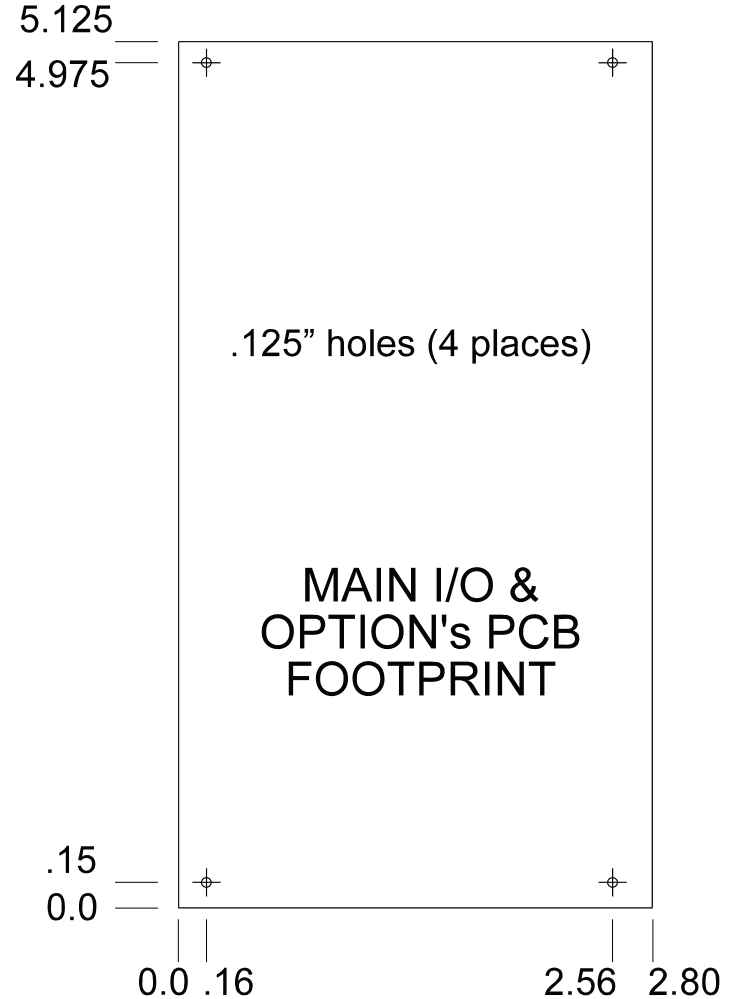

Diagram 6-6. Main I/O and PCB Dimensions

---

# A Ordering Information

---

## A Ordering Information

### HA71 Enclosures

PART NUMBER	DESCRIPTION
HA71SM*	SURFACE MOUNT (AGAINST FLAT SURFACE)
HA71PM	PANEL MOUNT RACK (INCLUDES BEZEL/RACK HARDWARE)
HA71N4	HA71SM IN NEMA 4X ENCLOSURE
HA71SS	HA71 Stainless Steel NEMA 4X Enclosure
HA71XP	HA71SM IN BOLT ON LID NEMA 7 ENCLOSURE

(INCLUDES MAGNETIC KEYPAD FOR NON-INTRUSIVE CONTROL)

\*HA71SM Surface mount package is the most basic model; includes loose 10-0185 Front Panel Nest Assembly and and 10-0142 MAIN I/O board. It supports Modbus® master and slave RS-485 I/O interfaces and has 5 amp form C relays for Alarm 1, Alarm 2, Fail and Horn alarm conditions. Analog and Discrete I/O is available by addition of the appropriate OPTION boards interfaced to the HA71 via an I2C serial expansion bus. Factory packaging of the HA71SM within a rack/panel mount enclosure (HA71PM), a NEMA 4X enclosure (HA71N4) and a NEMA 7 explosion-proof enclosure (HA71XP) is also available. These package styles support addition of up to 7 I<sup>2</sup>C option board footprints (3 w/o 10-0180 expansion kit option) inside each respective enclosure. Additional options may be added externally or in other enclosures.

### Optional Equipment

PART NUMBER	DESCRIPTION
10-0144	AUXILIARY COMMON ALARM RELAY BOARD (ADDITIONAL FORM C RELAY FOR ALM 1, ALM 2 & HORN)
10-0158	I <sup>2</sup> C ANALOG 8 INPUT BOARD INCLUDING EXC TERMINALS
10-0167	I <sup>2</sup> C ANALOG 4-20mA 8 OUTPUT BOARD
10-0195	I <sup>2</sup> C DISCRETE ALARM RELAY BOARD (8, 5A FORM C RELAYS)
10-0191	I <sup>2</sup> C CATALYTIC BEAD LEL SENSOR / mA INPUT BOARD
10-0192	DUAL CATALYTIC BEAD LEL MODULE (REQUIRES 10-0191)
10-0170	I <sup>2</sup> C RTD / RESISTIVE / 4-20mA 8 INPUT BOARD
10-0178	NEMA 4X EXPANSION ENCLOSURE FOR UP TO 8 OPTION PCB's
10-0180	NEMA 4X EXPANSION PLATE (ADDS UP TO 4 OPTION POSITIONS)
10-0172	85-240VAC UNIVERSAL INPUT 150 WATT 24VDC POWER SUPPLY
10-0208	FULL WIDTH 19" RACK (SUPPORTS 1 or 2 HA71SM's)



## Optional Equipment (cont'd)

PART NUMBER	DESCRIPTION
10-0229	I <sup>2</sup> C PRINTER INTERFACE WITH PARALLEL, RS-232, & RS-422 PORTS
10-0177	RS-485 TO RS-232 CONVERTER (RS-485 RTU TO PC DB9)
1000-1892	100db PIEZO AUDIBLE ALARM ADDED TO NEMA 4X ENCLOSURE
1000-1906	AMBER/RED DUAL LIGHT STACK w/ 80db HORN; GENERAL PURPOSE

## Spare Parts

PART NUMBER	DESCRIPTION
10-0142	Replacement Main I/O PCB for HA71/XP
10-0213	Replacement Main I/O PCB for HA71PM (ribbon connector on circuit side of PCB)
10-0006	Replacement HA71 Flat Panel LCD Module
10-0185	Replacement Complete HA71 Front Panel Electronic Nest Assembly Including 10-0006 LCD
10-0231	Replacement HA71 Front Graphic Panel
1000-1992	Replacement Main I/O PCB Fuse; 20mm / 2 amp
0010-1110	I <sup>2</sup> C 6 Inch I/O Cable
0010-1180	I <sup>2</sup> C 10 Inch I/O Cable
0010-1188	I <sup>2</sup> C 6 foot I/O Cable
1000-0078	"Big Blue" Magnetic Wand for XP Enclosures
1000-0076	"Small Red" Magnetic Wand for NEMA 4X Enclosures

---

**B Warranty** |

## Honeywell Analytics Warranty Statement

All products are designed and manufactured to the latest internationally recognized standards by Honeywell Analytics under a Quality Management System that is certified to ISO 9001.

As such, this instrument is warranted under proper use, to the original end-user purchaser, against any defects in materials or workmanship related failures for a period of 12 months from the date of first turn-on or 18 months from delivery from Honeywell Analytics to the customer, whichever is less. During this period, Honeywell Analytics will repair or replace defective parts on an exchange basis, F.O.B. to approved service centers on a global basis.

This warranty does not cover damage caused by accident, abuse, abnormal operating conditions or extreme poisoning of the sensor cartridge.

Defective equipment must be returned to Honeywell Analytics for repair. Before returning materials for repair or replacement, the Customer must obtain a Service Event Number (SE#) by contacting Honeywell Analytics Service in advance; include a detailed report stating the nature of the defect and ship the equipment prepaid to Honeywell Analytics' factory. If no detail report is included, Honeywell Analytics reserves the right to charge an investigative fee (prices available upon request) before any repair or replacement is performed. Returned goods must detail the Service Event Number (SE#) clearly on the package.

Service in the field or at the customer's premises is not covered under these warranty terms. Time and travel expenses for on-site warranty services will be charged at Honeywell Analytics' normal billing rates. Contact your Honeywell Analytics representative for information on available Service Contracts.

Honeywell Analytics shall not be liable for any loss or damage whatsoever or howsoever occasioned which may be a direct or indirect result of the use or operation of the Contract Goods by the Buyer or any Party.

This warranty covers the controller and parts sold to the Buyer only by authorized distributors, dealers and representatives as appointed by Honeywell Analytics. This warranty does not cover defects attributable to improper installation, repair by an unauthorized person or the use of unauthorized accessories/parts on the product. A warranty claim will only be accepted if a proof of purchase is submitted and all conditions obtained within this Warranty are met.

Honeywell Analytics reserves the right to validate any warranty claim prior to processing. Upon acceptance of a warranty claim, Honeywell Analytics will repair or replace the defective product free of charge. The initial warranty period is not extended by virtue of any works carried out there after.

Instruments which have been repaired or replaced during the warranty period are warranted for the remainder of the unexpired portion of the original warranty period. Honeywell Analytics is released from all obligations under its warranty in the event repairs or modifications are made by persons other than its own authorized personnel, unless such work is authorized in writing by Honeywell Analytics.

Honeywell Analytics reserves the right to change this policy at any time. Contact Honeywell Analytics for the most current warranty information.

**Find out more**

[www.honeywellanalytics.com](http://www.honeywellanalytics.com)

**Americas**

Honeywell Analytics  
405 Barclay Boulevard  
Lincolnshire, IL 60069  
Tel: +1 847 955 8200  
Toll free: +1 800 538 0363  
Fax: +1 847 955 8208  
[detectgas@honeywell.com](mailto:detectgas@honeywell.com)

**Europe, Middle East, and Africa**

Life Safety Distribution AG  
Wilstrasse 11-U11  
CH-8610 Uster  
Switzerland  
Tel: +41 (0)1 943 4300  
Fax: +41 (0)1 943 4398  
[gasdetection@honeywell.com](mailto:gasdetection@honeywell.com)

**Technical Services**

[ha.global.service@honeywell.com](mailto:ha.global.service@honeywell.com)

[www.honeywell.com](http://www.honeywell.com)

**Asia Pacific**

Honeywell Analytics  
#508, Kolon Science Valley (I)  
187-10 Guro-Dong, Guro-Gu  
Seoul, 152-050 Korea  
Tel: +82 2 2025 0300  
Fax: +82 2 2025 0329  
[analytics.ap@honeywell.com](mailto:analytics.ap@honeywell.com)



**Tollfree in Western Canada: 1-888-388-1592**  
**[microwatt.com](http://microwatt.com) • [mwsales@microwatt.com](mailto:mwsales@microwatt.com)**

**Please Note:**

While every effort has been made to ensure accuracy in this publication, no responsibility can be accepted for errors or omissions.  
Data may change, as well as legislation, and you are strongly advised to obtain copies of the most recently issued regulations, standards and guidelines.  
This publication is not intended to form the basis of a contract.

**Honeywell**