

RAELink3 Mesh User's Guide



FCC Part 15 statement

This device contains FCC ID: QNT PT2400GS20-A. This device complies with Part15 of the FCC rules. Operation is subject to the following two conditions: (1) This device may not cause harmful interference, and (2) this device must accept any interference received, including interference that may cause undesired operation.

Contents

1	Regulatory Information	3
2	Standard Contents	6
3	General Information	6
3.1	Configuration Options	7
3.1.1	Connection With Third-Party Devices	8
3.2	Key Features	9
4	Specifications.....	10
5	Charging The Battery	11
5.1	Detaching The Charging Adapter	12
5.2	Replacing The Li-ion Battery	13
5.3	Alkaline Battery Adapter	13
5.4	User Interface.....	15
6	Backlight.....	16
7	Display.....	16
8	Operating The RAELink3 Mesh.....	17
9	Modes Of Operation	17
9.1	Host Mode.....	18
9.2	Remote Mode.....	18
9.3	Repeater Mode.....	19
10	Turning The RAELink3 Mesh On.....	20
11	Turning The RAELink3 Mesh Off	21
12	Configuring The RAELink3 Mesh	21
12.1	Accessing Programming Mode.....	22
12.2	Setting The Network ID.....	23
12.3	Setting The Operation Mode.....	25
12.4	Setting The Unit ID.....	26
12.5	Mesh Radio Power Control.....	30
12.6	PAN ID	31
12.7	Channel	32
12.8	Cable Menu In Remote Mode	35
12.8.1	Cable Setting.....	37
12.8.2	Simultaneous Mesh And Cable Operation.....	37
12.9	Baudrate	38
12.10	GPS Status	38
12.11	GPS Coordinates Check.....	39
12.12	Modem Configuration Menu	40
13	Connecting A RAELink3 Mesh Remote Via Cable	41

- 14 GPS And Unobstructed Line Of Sight.....42
 - 14.1 Cleaning The RAELink3 Mesh.....43
 - 14.2 Ordering Replacement Parts43
 - 14.3 Special Servicing Note.....43
- 15 Troubleshooting.....44
- 16 Technical Support.....45
- 17 RAE Systems Contacts.....46

1 Regulatory Information

CAUTION!

To reduce the risk of electric shock, never open the modem cover during normal operation. This modem is certified to be used in Class I, Division 2 hazardous locations.



WARNINGS



Use only RAE Systems supplied charging adapter to charge the rechargeable battery pack inside the modem. Use only RAE Systems Lithium-Ion battery pack 029-3501-000 or alkaline battery pack, 029-3502-000. Recharge/replace batteries only in non-hazardous locations. The serial connection port may not be used in hazardous area.

STATIC HAZARD: Clean only with a damp cloth.

For safety reasons this equipment must be operated and serviced by qualified personnel only. Read and understand instruction manual completely before operating or servicing.

Proper Product Disposal At End Of Life



This symbol (crossed-out wheeled bin) indicates separate collection of waste electrical and electronic equipment in the EU countries. This product may contain one or more Nickel-metal hydride (NiMH), Lithium-ion, or Alkaline batteries. Specific battery information is given in this user guide.



Batteries must be recycled or disposed of properly. At the end of its life, this product must undergo separate collection and recycling from general or household waste. Please use the return and collection system available in your country for the disposal of this product.

Specifications

Dimensions	4.73" x 3.4" x 1.85" (120 mm x 86 mm x 48 mm)
Weight	17.3 oz (490 g)
Battery	Rechargeable 7.4V Lithium-Ion battery pack Alkaline battery pack (7.5V, five alkaline batteries)
LCD Display	Backlit with icons and text
Attachment	Belt Clip
Temperature	-20° C to 55° C (-4° F to 131° F)
Humidity	0% to 95% relative humidity (Non-condensing)
Safety Certification	Class I, Division 2, Groups A, B, C, D, T4

For rechargeable battery pack, 029-3501-000:



WARNING



To reduce the risk of ignition of hazardous atmospheres, recharge/replace battery only in area known to be non-hazardous.

Ne charger les batteries que dans l'emplacement désigné non dangereux.

For alkaline battery pack, 029-3502-000:

Note: Do not mix old and new or different types of batteries. Do not change batteries in hazardous locations.

Antenna Lock

Caution: To reduce risk when operating in potentially explosive atmospheres, ensure the antenna is locked in place with set-screw to prevent inadvertent disconnection.

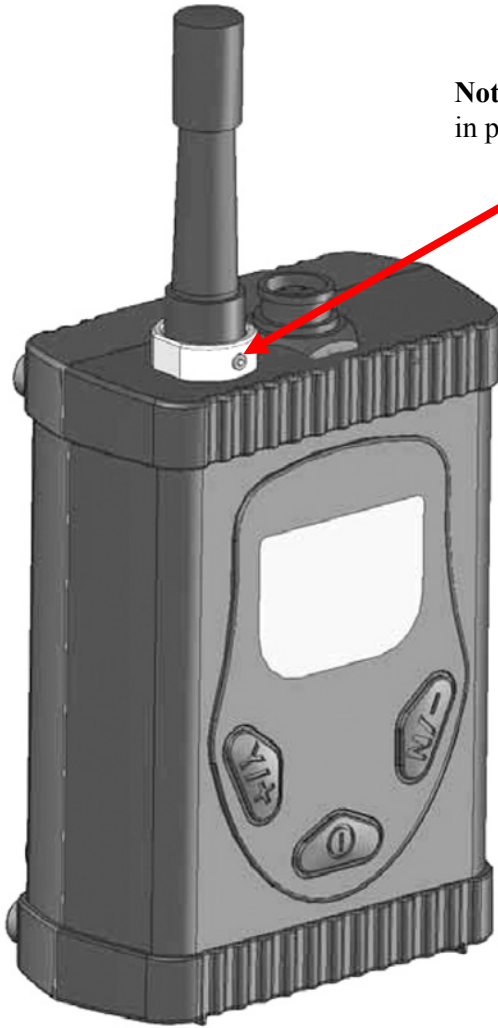

Note: Antenna must be locked in place with set-screw

2 Standard Contents

- RAELink3 Mesh
- Charging adapter with AC cable
- Alkaline battery adapter
- RS-232 computer interface cable
- Coiled serial cable (for connection to devices without mesh radio)
- RAELink3 Mesh Quick Reference Guide
- RAELink3 Mesh Resource CD
- Whip antenna (for use when RAELink3 Mesh is in Remote mode)
- 5dBi antenna with 12' cable and magnetic mount (for use when RAELink3 Mesh is in Host or Repeater mode)
- Hard transport case

3 General Information

The RAELink3 Mesh is a compact, portable radio-frequency modem that provides long-range wireless communication between remote portable gas monitors (PGMs) such as RAE Systems' ToxiRAE Pro, MultiRAE Series, etc., and a base station/computer for comprehensive monitoring. Up to eight monitors can connect to a RAELink3 Mesh in Remote mode at the same time, and up to 64 monitors equipped with RAELink3 Mesh units can be networked with a single Host. In addition, for applications requiring long-distance monitoring or monitoring in locations with obstructions to clear line-of-sight communication, RAELink3 Meshes configured as Repeaters extend the effective reach of the system.

RAELink3 Mesh User's Guide

3.1 Configuration Options

The RAELink3 Mesh can be configured to act in one of the following three modes:

1. Remote. The RAELink3 Mesh in Remote mode functions as a slave modem and communicates to a host modem or RAELink3 with the same network ID.

2. Host. The RAELink3 Mesh in Host mode functions as a host modem and communicates with multiple RAELink3-compatible radio-enabled RAE Systems products with the same network ID. It must be connected via cable to a PC running ProRAE Guardian software.

3. Repeater. The RAELink3 Mesh in Repeater mode functions as a repeater for RAELink3 Mesh modems in Remote mode or other RAELink3 modems with the same Network ID.

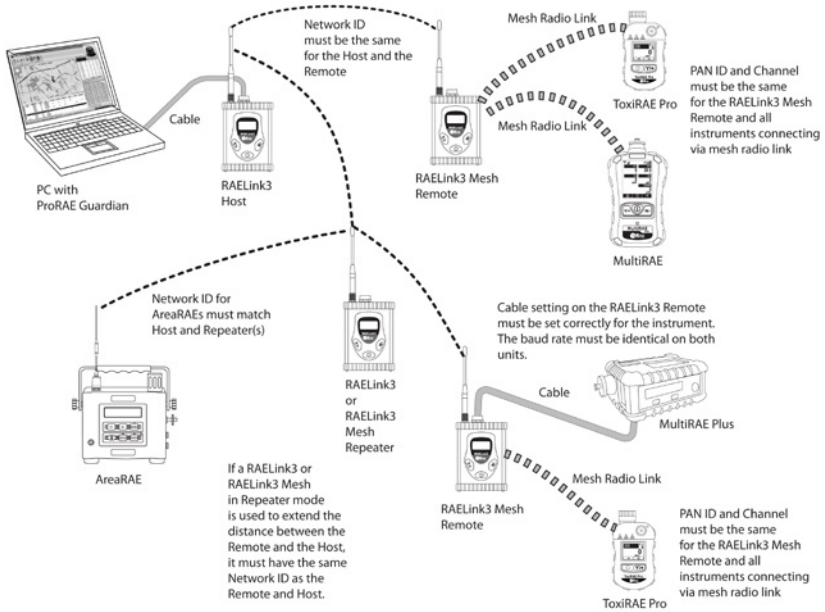

RAELink3 Mesh User's Guide

Connection With Third-Party Devices

The RAELink3 Mesh can be configured as a slave modem to communicate sensor data from select third-party monitors to a host modem with the same Network ID. Third-party monitors available to choose from include ChemRAE, DustTrak2, and AP4C.

Note: Some third-party monitors require a custom cable for connection with a RAELink3 Mesh.



3.2 Key Features

- Onboard mesh license-free radio modem for linking with instruments within 10 meters
- Onboard long-range license-free radio for transmission of data up to 2 miles
- Onboard microcomputer provides flexible protocol translation in order to interface to most monitoring devices via a serial port
- Onboard GPS receiver provides global positioning capability
- Onboard LCD displaying radio signal strength, GPS tracking status, and battery life
- Long operating time from built-in rechargeable Li-Ion battery pack (up to 14 hours of continuous operation)

Note: Up to nine monitors can connect to one RAELink3 Mesh using mesh-radio (8) and serial cable (1) connection.

4 Specifications

Dimensions	4.73" x 3.4" x 1.85" (120 mm x 86 mm x 48 mm)
Weight	17.3 oz (490 g)
Battery	Rechargeable 7.4V/1650mAh Lithium-Ion battery pack Alkaline battery pack (7.5V, five alkaline batteries)
Operating Time	Up to 14 hours of continuous operation.
LCD Display	Backlit with icons and text
Keypad	3 keys: Y/+, N/-, and MODE
Sensitivity	-108dBm at 10^{-6} bit error rate
Data Rate	Up to 115.2 kbps
Error Detection	32 bps CRC, retransmit on error
Data Interface	Mesh radio, RS-232
GPS Accuracy	Within 5 meters
Temperature	-20° C to 55° C (-4° F to 131° F)
Humidity	0% to 95% relative humidity (Non-condensing)
IP Rating	IP-65
Safety Certification	Class I, Division 2, Groups A, B, C, D, T4

5 Charging The Battery

It is recommended to fully charge the battery before using the RAELink3 Mesh. The Li-ion battery is charged by attaching the instrument to the Charging Adapter.

Follow this procedure to charge the instrument:

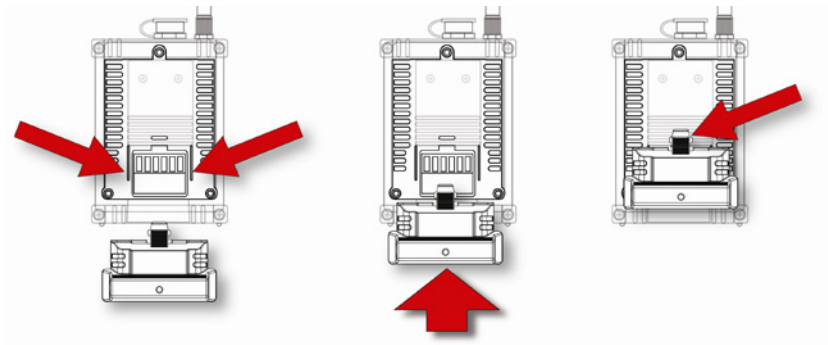

1. Align the Charging Adapter with the back of the RAELink3 Mesh (two guides match indents on the back of the Charging Adapter).
2. Slide the Charging Adapter onto the back of the RAELink3 Mesh.
3. Make sure the latch clicks into place.
4. Plug the power supply's barrel connector into the input on the side of the Charging Adapter.
5. Plug the power supply into the wall outlet.

The LED Charging Indicator in the Charging Adapter should glow red to indicate it is charging, and glow green when the battery is fully charged.

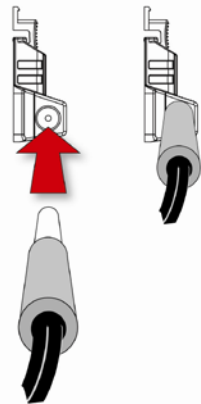
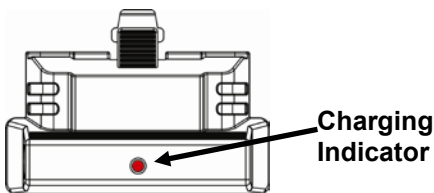

5.1 Detaching The Charging Adapter

To detach the Charging Adapter, press in on the latch. While pressing the latch, slide the Charging Adapter down.

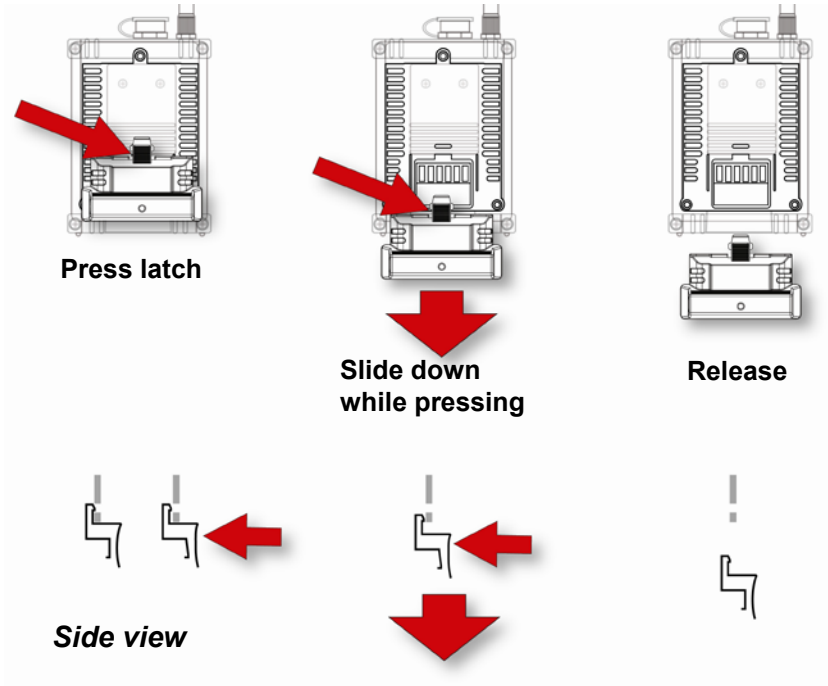

5.2 Replacing The Li-ion Battery

1. Turn off the instrument.
2. Located on the rear of the instrument are three screws. Loosen all three screws, and lift the battery out of the RAELink3 Mesh. Remove the battery pack from the battery compartment by lifting it out.

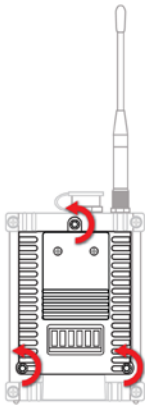

**Loosen
Screws**

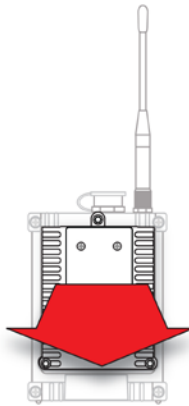

**Lift
Battery**

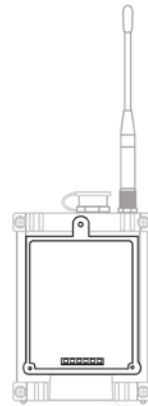

**Remove
Battery**

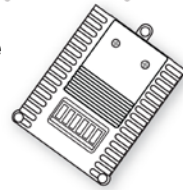

3. Replace a fully charged spare battery pack inside the battery compartment. Make sure the battery pack is oriented properly inside the compartment.
4. Press the battery into place with your hand, and then tighten the three screws.

5.3 Alkaline Battery Adapter

An alkaline battery adapter is supplied with the RAELink3 Mesh. The adapter (part number 029-3502-000) accepts five AA alkaline batteries (use only Duracell MN1500 or Energizer E91) and provides approximately 12 hours of operation. The adapter is intended to be

RAELink3 Mesh User's Guide

used in emergency situations when there is no time to charge the Li-ion battery pack.

To insert batteries into the adapter:

1. Remove the three Philips-head screws to remove the battery (alkaline or rechargeable).
2. Turn over the alkaline battery adapter and remove the two Philips screws.
3. Lift off the cover (there are two small indexing tabs at the end opposite the two screws).
4. Insert five fresh AA batteries as indicated by the polarity (+/-) markings.
5. Replace the cover. Replace the two Philips screws.
6. Set the alkaline battery adapter into the RAELink3 Mesh.
7. Tighten the three Philips screws.

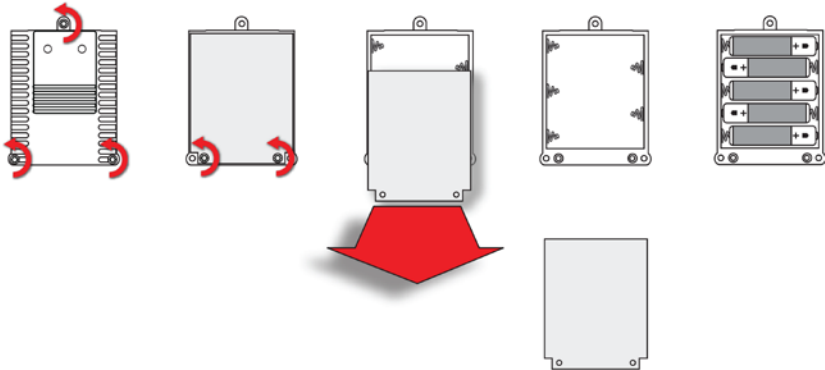

IMPORTANT!

Alkaline batteries cannot be recharged. If you place the RAELink3 Mesh in its Charging Cradle, the alkaline batteries will not be recharged.

Note: When replacing alkaline batteries, dispose of old ones properly.

Note: Do not mix old and new or different types of batteries. Do not change batteries in hazardous locations.

5.4 User Interface

The instrument's user interface consists of the display and three keys. The keys are:

Y/+
MODE
N/-

The LCD display provides visual feedback that includes the reading, time, battery condition, and other functions.

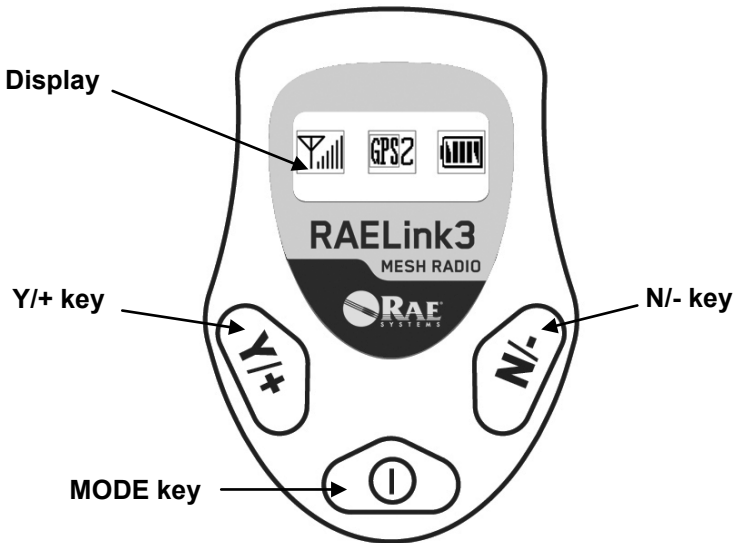

[Y/+] increases values, [MODE] acts as on/off and save, and [N/-] selects “no” and advances to the next function. In addition, [Y/+], [MODE], and [N/-] act as “soft keys” that control different parameters and make different selections within the instrument's menus. From menu to menu, each key controls a different parameter or makes a different selection.

6 Backlight

The LCD display is equipped with an LED backlight to assist in reading the display under poor lighting conditions. Press any key to turn on the backlight. It automatically turns off after 15 seconds.

7 Display

The display shows the following information:

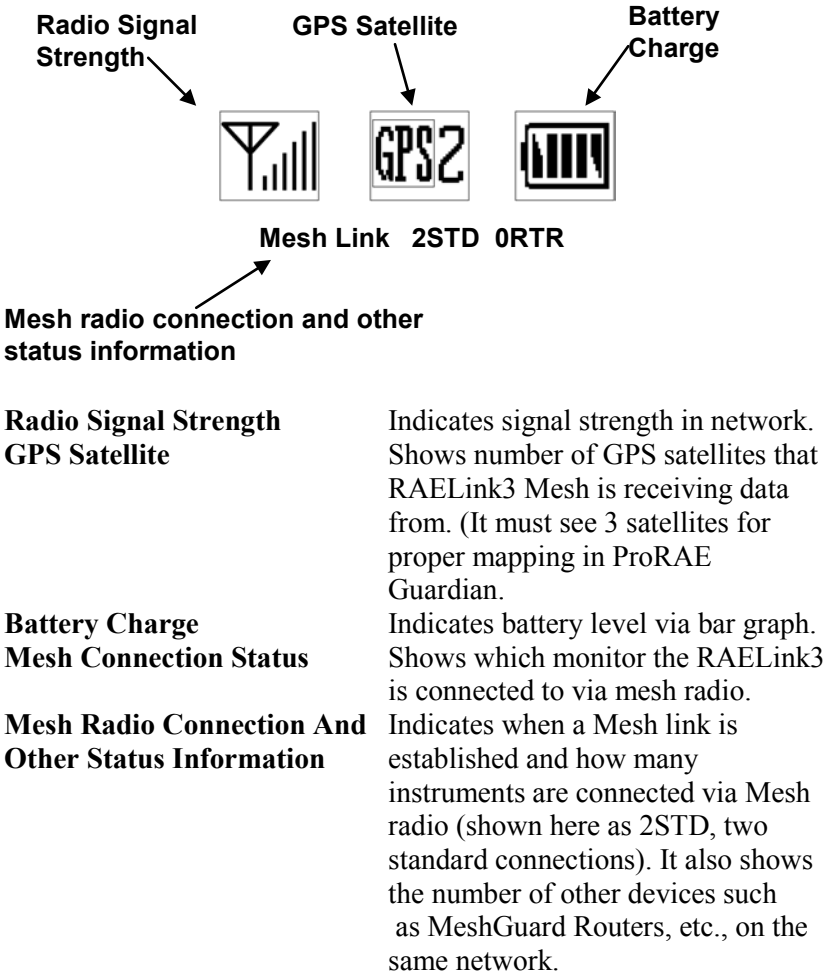

8 Operating The RAELink3 Mesh

The RAELink3 Mesh operates with two simultaneous modes of data transfer. First, it can use wireless mesh radio or a cable to connect to a portable gas monitor or other compatible detector. Second, it uses radio-frequency communication to transmit and receive data with a base station.

The following section covers configuration and operation of the modem portion of the RAELink3 Mesh.

IMPORTANT!

Before operating any RAELink3 Mesh modems in the field, test them to make sure they are properly configured for your network.

Each RAELink3 Mesh must have the proper network ID so that it is compatible with the RAELink3 wireless monitoring system.

9 Modes Of Operation

The RAELink3 Mesh can be configured to operate in one of three modes:

- Host
- Remote
- Repeater

Unless specified otherwise, the RAELink3 Mesh is factory-configured to operate in the Remote Mode. You can change the operation mode via the menus that you reach when you enter Programming Mode (see page 22 for details).

RAELink3 Mesh User's Guide

9.1 Host Mode

This mode designates the RAELink3 Mesh as Host (master) in a network. It can simultaneously communicate with numerous Remotes and Repeaters.

Note: There can only be one Host in a network. It is typically connected to a computer (PC) running ProRAE Guardian software for monitoring.

After the modem is properly configured, connect the serial interface cable to the PC's serial (RS-232) port. If the computer does not have a serial port, use a USB-to-9-pin Serial Adapter (part number 410-0210-000) to connect the cable to the computer. The DB9 connector should be firmly attached to the computer's DB9 serial port (insert the connector into the receptacle and then finger-tighten the connector's two long screws). Connect the other end of the cable to the data connector on the RAELink3 Mesh. Turn on power to the RAELink3 Mesh. It is now ready for data communication.

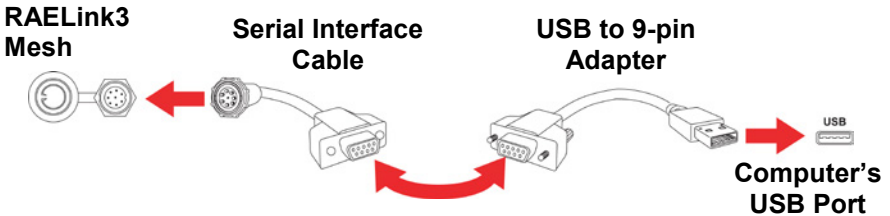

9.2 Remote Mode

In this mode, the modem passes all data from the monitor to the Host. The LCD displays the radio signal strength, GPS satellites, and battery charge. The mesh connection status is also displayed on the LCD screen.

For ChemRAE, DustTrak2, and AP4C. In these sub-modes of Remote Mode, the modem passes all data from the selected third-party device to a host.

RAELink3 Mesh User's Guide

Remote Mode is designed so that a RAELink3 Mesh modem can be used as a drop-in replacement for an existing RAELink or RAELink2 modem without modification.

9.3 Repeater Mode

In Repeater mode, the modem functions as a repeater. It does not interpret or process the data that passes through it. Its function is to extend the distance between a RAELink3 Mesh in Remote mode (or a RAELink3) and a Host, or to route the signal to deal with obstructions to line-of-sight communication.

Important!

When the RAELink3 Mesh is in Repeater mode, its GPS module is automatically turned off (indicated in the display as “GPSoff”) and the mesh-radio modem is also turned off. Its Network ID must match the Network ID being used by the Host and Remote modems.

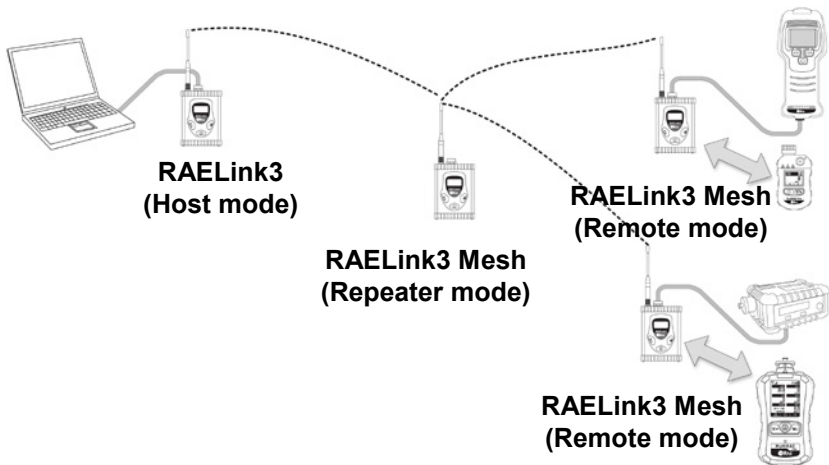

10 Turning The RAELink3 Mesh On

1. Press and hold [MODE].
2. When the display turns on, release the [MODE] key.

The RAE Systems logo should appear first. (If the logo does not appear, there is likely a problem and you should contact your distributor or RAE Systems Technical Support.) The firmware version is shown, along with the date of installation, and then the RAELink3 Mesh's serial number.

Once the startup procedure is complete, the instrument shows a numerical reading screen with antenna signal strength, battery capacity, and GPS icons, and (if GPS is turned on) the number of satellites the RAELink3 Mesh is receiving positioning data from.



Net ID=20 Remote
Mesh Link 1STD 0RTR

Two status lines are shown below the icons. The first line indicates the Network ID, followed by the mode in which the RAELink3 Mesh is configured (Remote, Repeater, or Host).

The second line shows how many instruments are linked to the RAELink3 Mesh through the mesh radio (shown as STD), as well as how many are connected through the unit (indicated as RTR). This indicates that the instrument is fully functional and ready to use.

11 Turning The RAELink3 Mesh Off

1. Press and hold the [MODE] key for 3 seconds. The display shows “Shutting Down...” and a 5-second countdown to shutoff begins.
2. When you see “Unit off...” release your finger from the [MODE] key. The instrument is now off.

Note: You must hold your finger on the key for the entire shutoff process. If you remove your finger from the key during the countdown, the shutoff operation is canceled and the instrument continues normal operation.

12 Configuring The RAELink3 Mesh

The RAELink3 Mesh modem is a programmable “smart” modem that can be configured to operate in Host, Repeater, or Remote Modes. These options are selected in Programming Mode, along with other

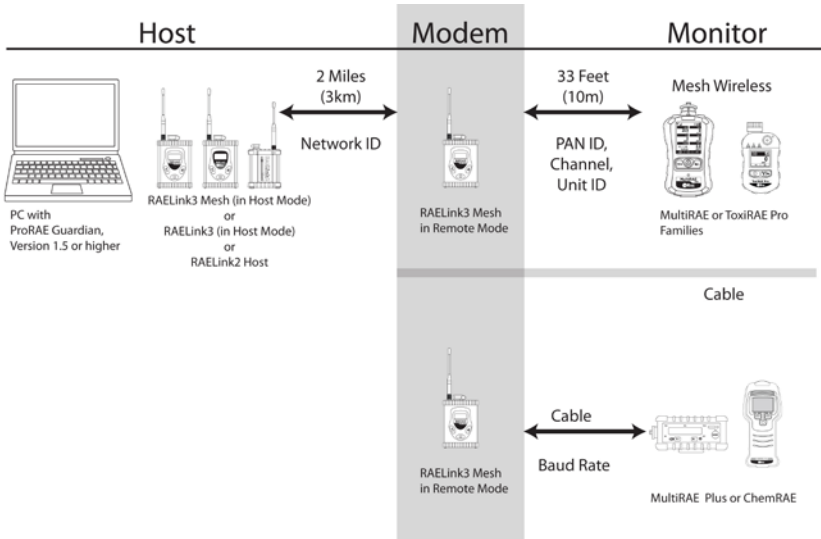

RAELink3 Mesh User's Guide

parameters for setting the Network ID, Unit ID, PAN ID, GPS on/off state, GPS coordinates check, Modem menu and Op Mode, Cable, and Mesh Radio Power on/off. All configurations are performed using the three front-panel keys and the display.

A RAELink3 Mesh in Remote mode must have the same Network ID as the RAELink-series modem being used as a Host. In addition, Each RAELink3 Mesh that is wirelessly communicating with one or more instruments (such as a ToxiRAE Pro or MultiRAE) must have the same PAN ID and Channel numbers as those instruments

12.1 Accessing Programming Mode

Note: You can exit Programming Mode at any time by pressing [MODE], except when in the Set Network ID and Set Unit ID menu screens.

With the RAELink3 Mesh turned on, press and hold both [MODE] and [N/-] for 3 seconds. The RAELink3 Mesh enters programming mode. The Network ID screen is displayed:

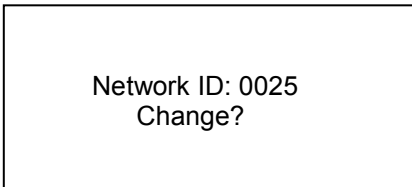

It shows the currently used Network ID and asks if you want to change it.

Note: When Programming Mode is accessed, the icons are minimized and relocated to the top of the display.

If you want to change the Network ID, press [Y/+]. If not, press [N/-] to move to the next screen. If you want to exit Programming Mode, press [MODE].

12.2 Setting The Network ID

Each Host, Remote, and Repeater on the same network must have the same Network ID. In addition, any other RAELink-series wireless modems in the same network need to be configured with the same Network ID.

RAELink3 Mesh modems come from the factory programmed to a unique random network ID, or programmed to match an existing system as specified by the customer. To enable a different Network ID, the number must be set to a value between 1 and 4095, *except* 255.

When changing the Network ID, the cursor flashes on the selected digit, highlighting it and indicating that you can change it:

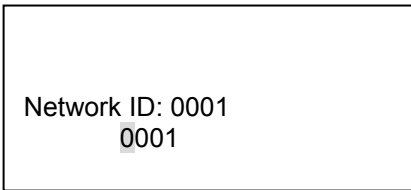

1. Press [Y/+] to increase the number or [N/-] to decrease the number.
2. Press [MODE] to advance to the next digit.
3. Input a network ID (except 255).

To accept the new Network ID, press and hold [MODE] for 2 seconds. A confirmation screen appears, as shown here:

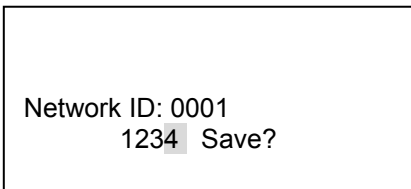

Press [Y/+] to save, or press [N/-] to abort the change.

RAELink3 Mesh User's Guide

If you save the Network ID, you see this display as it saves:

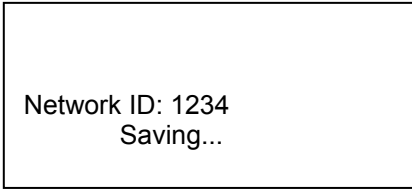

When it is done, the display returns to the Set Network ID screen, showing the new Network ID:

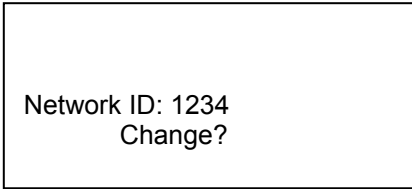

If you want to change the Network ID, repeat the procedure.

To progress to the next screen, Set Operation Mode, press [N/-].

12.3 Setting The Operation Mode

The Operation Mode determines whether the RAELink3 Mesh operates as a Host, Remote, or Repeater. In addition, under “Remote” are sub-modes for Mesh and Cable connection with local devices such as the ChemRAE, AP4C, DustTrak2, and other cable-connectable point-to-point RAE Systems monitors.

IMPORTANT!

There can only be one Host in a network. If more than one RAELink3, RAELink3 Mesh or earlier-generation RAELink wireless modem in a network is designated as a Host, the network will not function properly.

The operation mode program screen looks like this:

A rectangular box representing a screen with the text "OP Mode: Remote" on the top line and "Change?" on the bottom line, centered.

Press [Y/+] to change the Operation Mode, or press [N/+] to skip it.

If you press [Y/+], you see the Operation Mode (OP Mode) screen:

A rectangular box representing a screen with the text "OP Mode: Remote" on the top line and "OP Mode= Host?" on the bottom line, centered.

Press [N/-] to step through these options:

- Host
- Remote
- Repeater

RAELink3 Mesh User's Guide

Once you have made your selection, press [Y/+] to save the change.



After the change is saved, the display returns to the beginning screen for Operation Mode (your choice of Operation Mode is shown):

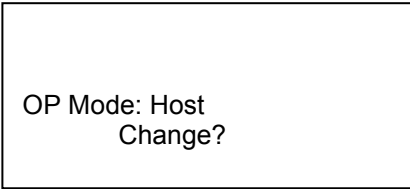

Press [Y/+] if you want to change the Operation Mode, or press [N/+] to advance to the GPS Power Control screen.

12.4 Setting The Unit ID

Unit ID is used to identify the RAELink3 Mesh within ProRAE Guardian. (ProRAE Guardian shows the unit ID number, and any monitors connected to that RAELink3 Mesh show up with a unit ID that is equal to the unit ID of the RAELink3 Mesh followed by a dash and the radio serial number of the gas monitor; for example, RAELink3 Mesh with Unit ID 1, then ToxiRAE Pro with Unit ID of 1-xxxx.)

When RAELink3 Mesh is configured as a Remote, the Set Unit ID menu screen looks like this:

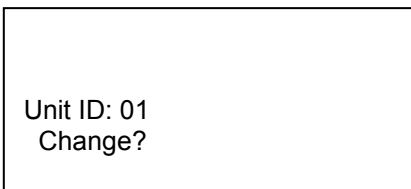

RAELink3 Mesh User's Guide

Press [Y/+] if you want to change the Unit ID. When changing the Unit ID, the cursor flashes on the selected digit, highlighting it and indicating that you can change it:

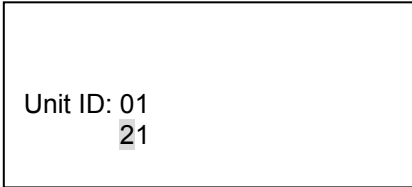

1. Press [Y/+] to increase the number or [N/-] to decrease the number.
2. Press [MODE] to advance to the next digit.
3. Input a Unit ID (00 through 64).

To accept the new Unit ID, press and hold [MODE] for 2 seconds. A confirmation screen appears, as shown here:

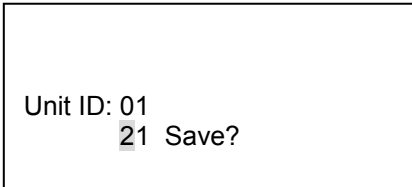

Press [Y/+] to save, or press [N/-] to abort the change.

If you save the Unit ID, you see this display as it saves:

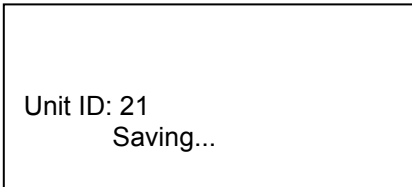

RAELink3 Mesh User's Guide

When it is done, the display returns to the Set Unit ID screen, showing the new Unit ID:

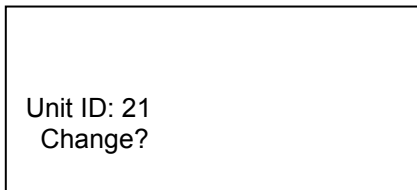

If you want to change the Unit ID, repeat the procedure.

To progress to the next screen, press [N/-]-Key.

To connect two devices simultaneously, make sure of the following:

- Each device must have a unique Unit ID.
- The correct device must be selected in the Mesh and Cable menus.

Example: To connect a ChemRAE via cable and a MultiRAE via mesh radio communications to the same RAELink3 Mesh, in Remote settings, select “Cable: ChemRAE.” Then press [Y/+].

Note: If one of the two channels (Cable or Mesh) is not connected to a device, it is not necessary to select a setting for the unused channel.

RAELink3 Mesh User's Guide

Here is an example of the connections that should be made when multiple devices are used with each RAELink3 Mesh:

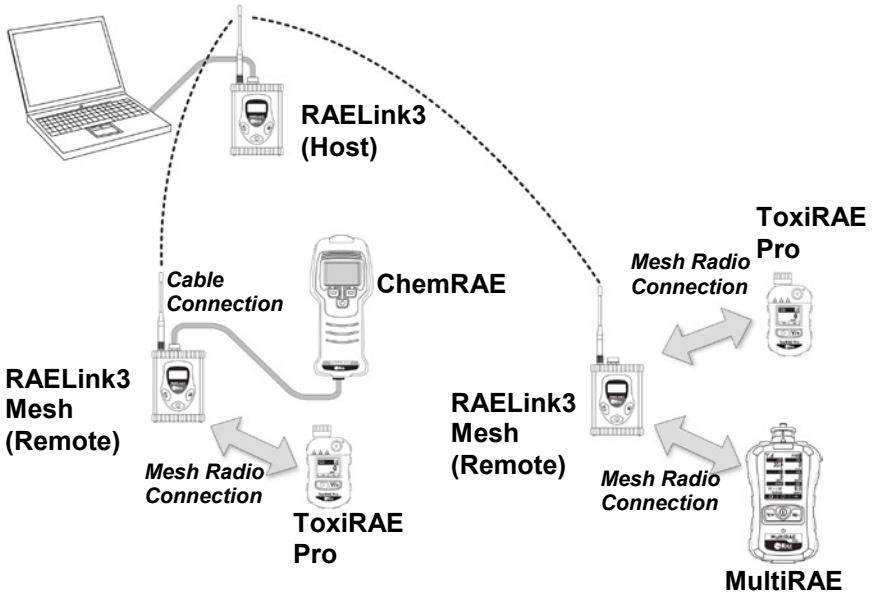

12.5 Mesh Radio Power Control

The onboard mesh radio connection can be turned on or off. The Mesh Radio Power Control screen is shown here:

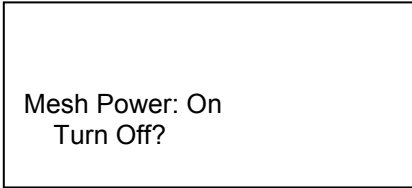

Press [Y/+] to change the on/off status, or press [N/-] to skip to next menu screen, Set Unit ID.

If you press [Y/+] and change the on/off status, the status is toggled and the screen displays the change:

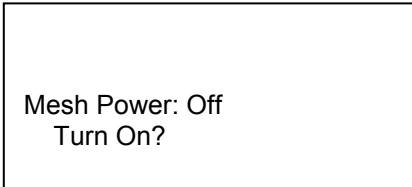

When you are satisfied with the mesh radio status, you can advance to the next menu screen, Set Unit ID, by pressing [N/-].

12.6 PAN ID

The RAELink 3 Mesh and all instruments being paired wirelessly with it in Remote mode must be programmed with the same Pan ID (Personal Network Identifier) to ensure communication compatibility.

When RAELink3 Mesh is configured as a Remote, the Set PAN ID menu screen looks like this:

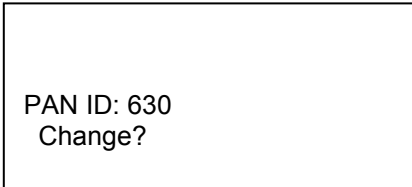

Press [Y/+] if you want to change the PAN ID. When changing the PAN ID, the cursor flashes on the selected digit, highlighting it and indicating that you can change it:

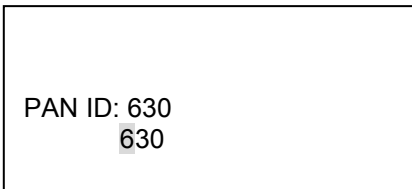

1. Press [Y/+] to increase the number or [N/-] to decrease the number.
2. Press [MODE] to advance to the next digit.
3. Input a PAN ID. (The range is 001 to 999.)

To accept the new PAN ID, press and hold [MODE] for 2 seconds. A confirmation screen appears, as shown here:

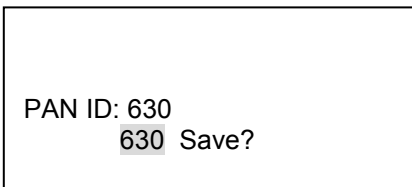

RAELink3 Mesh User's Guide

Press [Y/+] to save, or press [N/-] to abort the change.

If you save the PAN ID, you see this display as it saves:

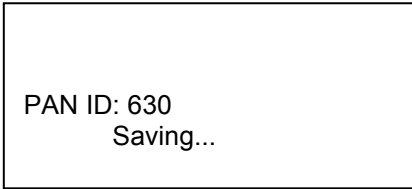

When it is done, the display returns to the Set PAN ID screen, showing the new PAN ID:

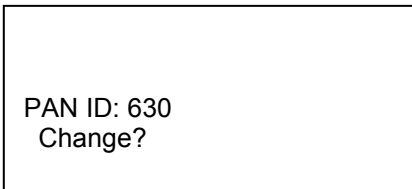

12.7 Channel

The RAELink3 Mesh and all instruments communicating wirelessly with it must operate on a single channel. The available channels vary by the internal wireless modem's frequency, and ranges are set by RAE Systems to correspond with the wireless modem. Check the label on your RAELink3 Mesh if you are unsure of the frequency.

These are the frequencies and channels:

900 MHz: Channel 0 (channel cannot be changed)

2.4 GHz: Channels 11 through 26

Note: If you try to program a channel that is not accepted, the RAELink3 Mesh displays an error message of "Invalid Input" when you try to save the new channel number.

Note: choosing Join Network in the gas monitor wireless setup menu automatically sets the Channel to match the Channel of a corresponding Remote modem with same PAN ID.

RAELink3 Mesh User's Guide

In Programming Mode, the Channel screen is shown like this, indicating the currently used channel:

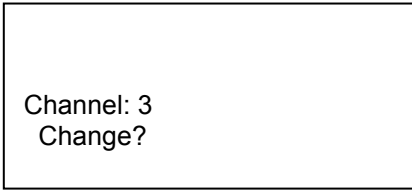

Press [Y/+] if you want to change the channel. The first digit is highlighted:

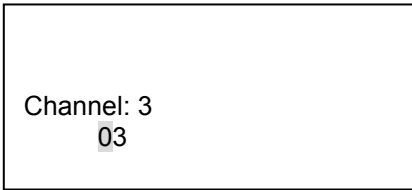

1. Press [Y/+] to increase the number or [N/-] to decrease the number.
2. Press [MODE] to advance to the next digit.
3. Input a Channel number.

Once you have input the number you want, press and hold [MODE] until you are asked to save it:

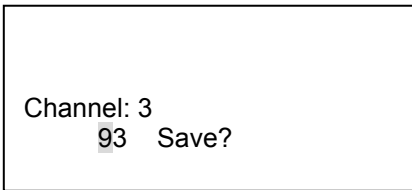

Press [Y/+] to save the new channel number, or press [N/-] to keep the current channel number and proceed to the next menu item.

RAELink3 Mesh User's Guide

If you have input a channel number that is not valid for the radio module, the screen tells you that it is not a valid choice:

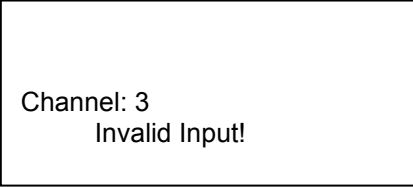

Channel: 3
Invalid Input!

The screen then changes to the first Channel screen, where you can input a valid Channel number by pressing [Y/+], or advancing to the Cable setting by pressing [N/-].

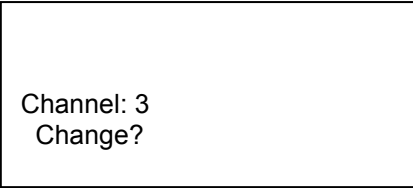

Channel: 3
Change?

12.8 Cable Menu In Remote Mode

When the RAE Link3 Mesh is in Remote mode, it allows settings for Cable connection with a RAE Systems monitor or some third-party monitors such as the ProEngin AP4C and TSI DustTrak2. Cable connectivity selections for a RAE Link 3 Mesh in Remote mode are organized as follows:

Remote Mode

Cable

Bypass
 RAE PTP
 AP4C
 ChemRAE
 DustTrak2

When connecting a Remote device wirelessly via mesh radio, you do not need to make a setting choice. However, if you are using an instrument that requires a cable, you must choose the appropriate setting for the connection type as listed below. For example, when connecting a ChemRAE, you must choose “ChemRAE” under the “Cable” menu.

Use this chart to guide you in choosing the correct setting:

Product	Connection	Setting
ToxiRAE Pro Series	Mesh radio	No setting necessary
MultiRAE Series	Mesh radio	No setting necessary
AP4C	Cable	AP4C
ChemRAE	Cable	ChemRAE
DustTrak2	Cable	DustTrak2
MiniRAE 2000	Cable	Bypass
MultiRAE Plus	Cable	Bypass
ppbRAE Plus	Cable	Bypass
QRAE Plus	Cable	RAE PTP

RAELink3 Mesh User's Guide

Here are simplified connection rules:

- ToxiRAE Pro series and MultiRAE Series use mesh radio wireless connection.
- All other products use Cable.
- If the name of the product is not listed in the submenu, then you must use Bypass.

Note: The only exception is the QRAE Plus, which requires Cable = RAE PTP.

When Remote Mode is selected, this screen is shown:

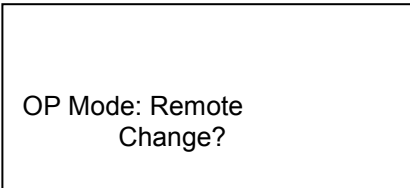

Press [N/-] to keep the RAELink3 Mesh in Remote Mode and to advance to the Cable menu. The screen looks like this:

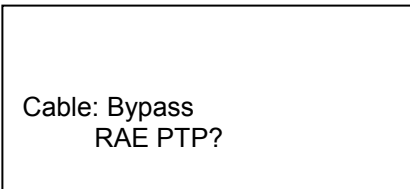

- Press [Y/+] if you want to change to another device in the list.
- Press [N/-] if you want to simply advance to Cable settings.

If you chose to change the cable-connected setting, then you can use the [Y/+] and [N/-] buttons to navigate through the list and make a selection.

RAELink3 Mesh User's Guide

12.8.1 Cable Setting

If a cable is used to connect a monitor to a RAELink3 Mesh in Remote Mode, you must make sure the correct setting is selected for proper operation.

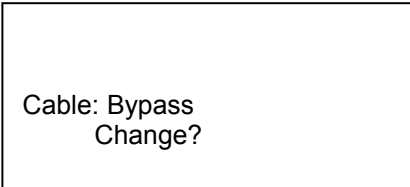

- Press [Y/+] if you want to change to another Cable setting in the list.
- Press [N/-] if you want to simply advance to GPS Status.

12.8.2 Simultaneous Mesh And Cable Operation

You can use a single RAELink3 Mesh in Remote mode to transmit data from mesh-radio-enabled and one cable-connected device simultaneously.

Here is a table showing supported RAE Systems and third-party devices, arranged by Cable or Mesh connection:

Cable	Mesh
QRAE Plus	ToxiRAE Pro Series
MultiRAE Plus	MultiRAE Series
ChemRAE	
DustTrak2	
AP4C	
MiniRAE 2000	
ppbRAE Plus	

12.9 Baudrate

Baudrate sets the speed of the data transfer between an instrument and the RAELink3 Mesh, if they are connected via cable. To ensure data is transferred efficiently, make sure the baud rate is set to its default (19200) or that the baud rate of the instrument and the RAELink3 Mesh match.

Available baud rates include: 9600, 19200, 38400, 57600, and 115200.

12.10 GPS Status

The onboard GPS can be turned on or off. The GPS Status screen is shown here:

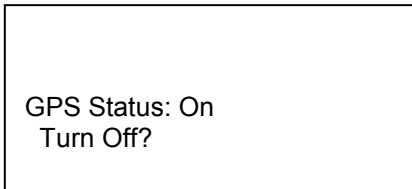

Press [Y/+] to change the power status, or press [N/-] to skip to next menu screen, GPS Coordinates Output.

If you change the power status of the onboard GPS, there is no confirmation screen. However, the status is updated immediately:



When you are satisfied with the GPS status, you can advance to the next menu screen, GPS Coordinates Check, by pressing [N/-].

12.11 GPS Coordinates Check

Check the RAELink3 Mesh's GPS location in this menu screen. If you want to have the coordinates checked and shown in the display, press [Y/+]. If not, press [N/-] to skip to the next menu screen.

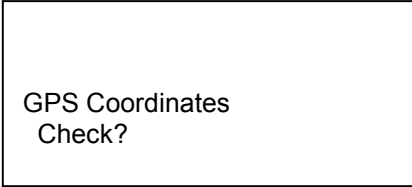

If you press [Y/+], the GPS coordinates are displayed as shown (the 0's are replaced by degrees, minutes, and seconds):

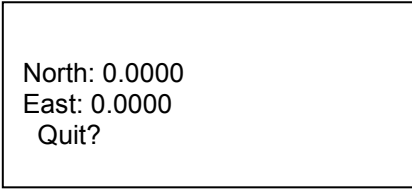

Press [Y/+] to quit. (Pressing [N/-] or [MODE] does not change the screen.) The first screen of GPS Coordinates Check is shown:

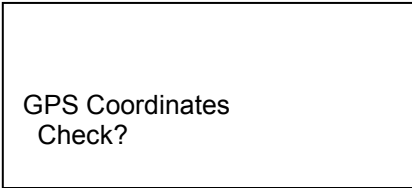

Press [N/-] to advance to the next screen, Mesh Radio Power Control.

12.12 Modem Configuration Menu

In this program mode, the onboard modem configuration menu can be output and accessed via PC using a HyperTerminal program.

IMPORTANT!

Do not enter and change any parameters in this menu unless directed to do so by authorized technical support personnel.

Note: The RAELink3 Mesh must be connected to a computer with a cable, and a HyperTerminal program must be running.

The Modem Configuration screen is shown here:

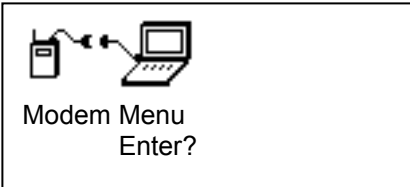

Press [Y/+] to output the modem menu to a PC, or press [N/-] to skip to the beginning of the programming menus

Alternatively, you can press [MODE] to exit Programming Mode.

13 Connecting A RAELink3 Mesh Remote Via Cable

Connect a portable gas monitor (PGM) such as a ppbRAE Plus, MiniRAE 2000, or MultiRAE Plus to the RAELink3 Mesh configured as a Remote using the optional Portable Coiled Cable (part number 400-0189-000).

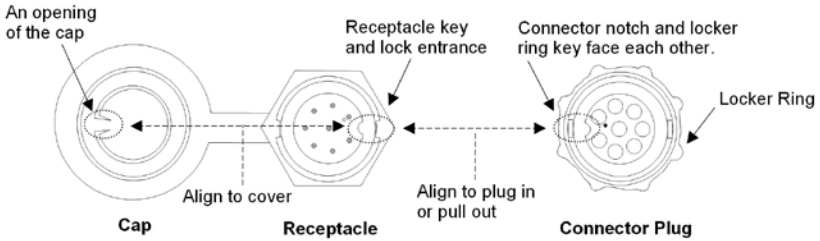

- Connect the serial cable's 4-pin circular connector to the monitor. (Third-party sensor or detector units require a cable that comes with the specifically configured RAELink3 Mesh.)
- Connect the other end to the RAELink3 Mesh.

Note: The cable connector that fits the RAELink3 Mesh's multi-function receptacle has a locking ring. Align the cable's connector plug with the RAELink3 Mesh's receptacle using the key and notch as a guide. Press the connector into place, and then turn the connector's locking ring to tighten the connection. Never force the connector in or out of the receptacle.

14 GPS And Unobstructed Line Of Sight

GPS receivers operate by line of sight with global positioning satellites. A receiver must be able to get signals from at least three satellites in order to calculate longitude and latitude (there are currently 30 GPS satellites orbiting the earth). The more satellites a GPS receiver can “see,” the more accurate and reliable the positioning.

For a GPS-equipped RAELink3 Mesh (or any other GPS device) to work properly, it must have a direct line of sight to a satellite, meaning it will not work well (if at all) indoors. Although radio signals from navigation satellites can pass through clouds, glass, plastic and other lightweight materials, satellite navigation receivers do not work underground or in other enclosed spaces.

If you need to operate a monitor under a roof or anything else that obstructs a clear view of the sky, you may need to take the RAELink3 Mesh outdoors into a nearby clear area, perform a manual GPS Coordinates Check (see page 39), and then either allow those coordinates to be used on maps in ProRAE Guardian running on a host computer, or input them manually.

14.1 Cleaning The RAELink3 Mesh

Occasional cleaning with a soft cloth is recommended. Do not use detergents or chemicals.

Visually inspect the contacts on the rear of the RAELink3 Mesh, on the battery, and on the Charging Adapter to make sure they are clean. If they are not, wipe them with a soft, dry cloth. Never use solvents, abrasives, or cleaners.

14.2 Ordering Replacement Parts

In the U.S., you can order sensors, replacement batteries, and other accessories online at:

<http://istore.raesystems.com/>

14.3 Special Servicing Note

If the instrument needs to be serviced, contact:

The RAE Systems Technical Service Department. Before returning the instrument for service or repair, obtain a Returned Material Authorization (RMA) number for proper tracking of your equipment. This number needs to be on all documentation and posted on the outside of the box in which the instrument is returned for service or upgrade. Packages without RMA Numbers will be refused at the factory.

15 Troubleshooting

Problem	Possible Reasons & Solutions
Cannot turn on power after charging the battery	Charge or replace battery.
Remote unit not communicating with Host Controller	<ul style="list-style-type: none"> • Confirm RAELink3 Mesh is in Remote Mode • Check the Network ID to make sure it is the same on both units. • Check the battery charge on the Remote unit • Make sure you have a unique Unit ID on each RAELink3 Mesh or device connected to a RAELink3 Mesh. • Check the cable or mesh radio connection between the RAELink3 Mesh and the remote device
Instrument does not link with RAELink3 Mesh via mesh radio.	<ul style="list-style-type: none"> • Make sure instrument's radio is turned on. • Check PAN ID, Channel, and Op Mode on the RAELink3 Mesh.
RAELink3 Mesh is not picking up satellites to load a map in ProRAE Guardian.	<ul style="list-style-type: none"> • Make sure GPS is turned on. • Make sure the RAELink3 Mesh has an unobstructed view of the sky.

16 Technical Support

To contact RAE Systems Technical Support Team:

Monday through Friday, 7:00AM to 5:00PM Pacific (US) Time

Phone (toll-free): +1 888-723-4800

Phone: +1 408-952-8461

Email: tech@raesystems.com

Life-critical after-hours support is available:

+1 408-952-8200 select option 9

17 RAE Systems Contacts

RAE Systems by Honeywell

World Headquarters

3775 N. First St.

San Jose, CA 95134-1708 USA

Phone: +1 408.952.8200

Fax: +1 408.952.8480

E-mail: customerserv@raesystems.com

Web Site: www.raesystems.com

RAE Systems Technical Support

Monday through Friday, 7:00 AM to 5:00 PM Pacific Time

Phone: +1.408.952.8461

Email: tech@raesystems.com

Life-critical after-hours support is available:

+1.408.952.8200 select option 9

RAE Systems Europe ApS

Kirstinehøj 23 A

DK-2770 Kastrup

Denmark

Phone: +45 86 52 51 55

Fax: +45 86 52 51 77

orders@raeeurope.com

sales@raeeurope.com

Web: www.raesystems.eu

RAELink3 Mesh User's Guide

RAE Systems UK Ltd

D5 Culham Innovation Centre
Culham Science Centre
Abingdon, Oxon OX14 3DB
United Kingdom

Phone: +44 1865408368

Fax: +44 1235531119

Mobile: +44 7841362693

Email: raeuk@raeeurope.com

RAE Systems France

336, rue de la fée des eaux
69390 Vernaison
France

Phone: +33 4 78 46 16 65

Fax: +33 4 78 46 25 98

Email: info-france@raeeurope.com

Web: www.raesystems.fr

RAE BeNeLux BV

Hoofdweg 34C
2908 LC Capelle a/d IJssel
The Netherlands

Phone: +31 10 4426149

Fax: +31 10 4426148

Email: info@rae.nl

Web: www.rae.nl

RAE Systems Spain, s.l.

Av. Remolar, 31
08820 El Prat de Llobregat
Spain

Phone: +34 933 788 352

Fax: +34 933 788 353

Mobile: +34 687 491 106

Email: mdelgado@raespain.com

Web: www.raespain.com

RAELink3 Mesh User's Guide

RAE Systems Middle East

LOB 7, Ground Floor, Office 19,
Jebel Ali Free Zone
Dubai, United Arab Emirates

Phone: +971.4.887.5562

Email: mesales@raesystems.com

RAE Systems (Hong Kong) Ltd.

Room 8, 6/F, Hong Leong Plaza
33 Lok Yip Road
Fanling, N.T, Hong Kong

Phone: +852.2669.0828

Fax: +852.2669.0803

Email: hksales@raesystems.com

RAE Systems Japan

403 Plaza Ochanomizu Bldg. 2-1
Surugadai Kanda Chiyoda-Ku
Tokyo, Japan

Phone: 81-3-5283-3268

Fax: 81-3-5283-3275

Email: jpsales@raesystems.com

RAE Systems Korea

#1010, DaeMyungAnsVill First,
Sang-Dong 412-2, Wonmi-Gu, Bucheon,
Kyungki-Do, Korea

Phone: 82-32-328-7123

Fax: 82-32-328-7127

Email: krsales@raesystems.com



**RAE Systems by Honeywell
World Headquarters**

3775 N. First St.
San Jose, CA 95134-1708 USA
Phone: 408.952.8200
Toll-Free: 888.723.4800
Fax: 408.952.8480

E-mail (sales support): raesales@raesystems.com
Web Site: www.raesystems.com

Technical Support

Phone: 408.952.8461 (Mon-Fri, 7AM-5PM, PST)
Email: tech@raesystems.com

Training

Courses: www.raesystems.com/support
Email: training@raesystems.com

Product Registration

www.raesystems.com/support/product-registration

RAE Systems Europe

Kirstinehøj 23A, DK-2770 Kastrup • Denmark
Phone: +45.8652.5155 • **Fax:** +45.8652.5177
Web: www.raesystems.eu • **Email:** sales@raeeurope.com

RAE Systems (Hong Kong) Ltd.

Units 1516-18, 15/F, Delta House, 3 On Yiu Street
Shatin, N.T. Hong Kong
Phone: +852.2669.0828 • **Fax:** +852.2669.0803
Web: www.raesystems.com.hk
Email: service@raesystems.com.hk

RAE Systems Middle East

LOB 7, Ground Floor, Office 19, Jebel Ali Free Zone
Dubai, United Arab Emirates
Email: mesales@raesystems.com • **Phone:** +971.4.887.5562

Rev. A
June 2012
P/N 029-4508-100