

ConsoliDator®

Multi-Channel Controller

Instruction Manual



ConsoliDator®



ConsoliDator 8

- Eight 4-20 mA Inputs
- Eight 24 VDC @ 20 mA
- Two 4-20 mA Outputs

ConsoliDator 4

- Four 4-20 mA Inputs
- Four 24 VDC @ 20 mA
- Four 4-20 mA Outputs

Features and Highlights

- Nine Form C 10 A Relays
- Four Pulse Inputs
- Four Digital Inputs
- Panel or wall mount
- Sum and Difference Functions
- Powered from AC or DC
- 32-Point Linearization
- RS-232 Modbus® RTU
- Square Root Function
- FREE Programming & data logging software

PRECISION DIGITAL CORPORATION
89 October Hill Road • Holliston MA 01746 USA
Tel (800) 343-1001 • Fax (508) 655-8990

**PRECISION
DIGITAL**

www.predig.com

Visit our Web Site
<http://www.predig.com/>

Disclaimer

The information contained in this document is subject to change without notice. Precision Digital Corporation makes no representations or warranties with respect to the contents hereof, and specifically disclaims any implied warranties of merchantability or fitness for a particular purpose.

All trademarks mentioned in this document are the property of their respective owners.

Copyright © 2009-2012 Precision Digital Corporation

This document contains ratings and requirements necessary for proper installation. Distribution of modified versions is strictly prohibited. Any text, chart, diagram, or table reproduced must be reproduced in its entirety without alteration.

INTRODUCTION

The ConsoliDator is an easy to use multiple-channel controller. It accepts 4-20 mA inputs, flow meter pulse inputs, and digital inputs. It is equipped with multiple relays, which all have user-definable actions, 4-20 mA outputs, and Modbus protocol communication capabilities.

ORDERING INFORMATION

ConsoliDator Controllers					
Model	Mounting	4-20 Inputs	Pulse Inputs	4-20 Outputs	Relays
PD980-8K9-15	Wall	8	4	2	9
PD981-8K9-15	Panel				
PD940-8K9-15	Wall	4	4	4	9
PD941-8K9-15	Panel				

Accessories	
Model	Description
PDA2901	NEMA 4X Enclosure for PD981 or PD941 models.
PDA2904	NEMA 4X Large Enclosure for PD981 or PD941 models.
PDP2901	Sub Panel with Terminal Strips for PDA2901 Enclosure.
PDP2902	Low-Cost Sub Panel without Terminal Strips for PDA2901.
PDP2904	Sub Panel with Terminal Strips for PDA2904 Enclosure.
PDP2905	Low-Cost Sub Panel without Terminal Strips for PDA2904.
PDA6901	2" Pipe Mounting Kit for PDA2901 Enclosure.
PDA6902	2" Pipe Mounting Kit for PDA2904 Enclosure.
PDX6901	Snubber .01µF, 470Ω, Flexible Leads.
PDA7485-I	RS-232 to RS422/485 Isolated Converter
PDA7485-N	RS-232 to RS422/485 Non-Isolated Converter
PDA8232-N	USB to RS-232 Converter
PDA8485-I	USB to RS422/485 Isolated Converter
PDA8485-N	USB to RS422/485 Non-Isolated Converter
PDA9232-01	ConsoliDator Null Modem Cable
PDA9232-02	RS-232 Computer Cable

Setup & Programming Services	
Part Number	Description
PDN-CSETUP2	Custom Setup & Programming
PDN-CERTCAL	Certificate of Calibration
PDN-CERTCAL2	Certificate of Calibration with Data

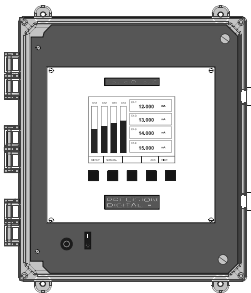

PDA2901
Optional enclosure features quick-release latches, a hinged front panel and internal space for mounting additional components such as relays and switches.

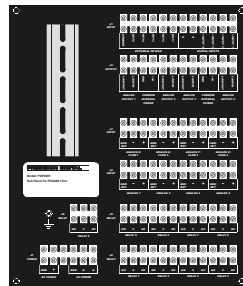

PDP2901
Optional sub panel features terminal strips for convenient installation of all power, analog, and relay lines using up to 8 AWG wire.

TABLE OF CONTENTS

INTRODUCTION ----- 3

ORDERING INFORMATION ----- 3

TABLE OF CONTENTS ----- 4

SPECIFICATIONS ----- 7

 General ----- 7

 4-20 mA Analog Inputs ----- 8

 Flow Meter Pulse Inputs ----- 8

 Digital Inputs ----- 8

 Relays ----- 9

 4-20 mA Transmitter Outputs ----- 10

 Modbus® Serial Communications ----- 10

 ConsoliDator® Software ----- 10

 Compliance Information ----- 10

SAFETY INFORMATION ----- 11

INSTALLATION ----- 12

 Unpacking ----- 12

 Wall Mounting ----- 12

 Panel Mounting ----- 13

 Connections ----- 14

 Power Connections ----- 14

 Input Signal Connections ----- 15

 4-20 mA Analog Input Connections ----- 15

 Flow Meter Pulse Input Connections ----- 16

 Digital Input Connections ----- 16

 Analog Output Connections ----- 17

Note: All inputs and outputs share a common ground. DO NOT power inputs and outputs with the same power supply. Relay Connections ----- 17

 Relay Connections ----- 18

 Switching Inductive Loads ----- 18

 Serial Communication Connections ----- 19

 Serial Communication Using RS-422/485 ----- 19

 External Keypad Connections ----- 19

NAVIGATING AND EDITING ----- 20

SETUP AND PROGRAMMING ----- 21

Main Setup Menu ----- 22

 General Functions ----- 22

 Buzzer ----- 22

 Time Out ----- 22

 Password ----- 22

 Backlight ----- 23

 Baud Rate ----- 23

 Parity ----- 23

 Modbus ID ----- 23

Tx Delay-----	23
Configuring 4-20 mA Inputs-----	24
Display Preferences-----	24
Decimal Point-----	24
Units-----	24
Bargraph-----	24
Input Scaling & Math Functions-----	25
Linear-----	25
Square Root-----	26
Exponent-----	27
Integration Mode-----	28
Fixed Value-----	28
Summation & Difference-----	28
Multi-Point Linearization-----	29
Sensor Input Setup-----	29
Setting Flow Meter Pulse Inputs-----	30
Display Parameters-----	30
Input Configuration Parameters-----	30
Programming Relays-----	31
Supervisory or Summary Alarm Modes-----	31
High or Low Alarm Modes-----	31
Multi-Channel High or Low Alarm Modes-----	32
High or Low Pulse Alarm Modes-----	33
Trigger Alarm Mode-----	34
Annunciator High or Low Alarm Modes-----	34
Plunger Lift by Differential Pressure Mode-----	35
Plunger Lift by Time Mode-----	35
Lead-Lag Modes (Pump Alternation Control)-----	36
Linear Pulse Width Modulation Mode-----	38
Proportional Plus Integral Pulse Width Modulation Mode-----	39
Setting 4-20 mA Outputs-----	40
Linear Scaling of 4-20 mA Output-----	40
PID Control Using 4-20 mA Output-----	40
OPERATION-----	41
Manual and Simulation Modes-----	45
Contrast Adjustment Control-----	46
MODBUS® SERIAL COMMUNICATION-----	47
Modbus Register Tables-----	47
CONSOLIDATOR MONITOR SOFTWARE-----	52
Connecting to PC-----	52
Installing Software-----	52
Using ConsoliDator Monitor Software-----	52
Data Logging-----	53
Programming Through Software-----	53
OVERALL DIMENSIONS-----	54
TROUBLESHOOTING TIPS-----	55

Table of Figures

Figure 1. Wall Mount Dimensions (PD980 & PD940)	12
Figure 2. Panel Mount Dimensions (PD981 & PD941)	13
Figure 3. Power Connections	14
Figure 4. Transmitter Powered by Ext. Supply or Self-Powered	15
Figure 5. Transmitters Powered by ConsoliDator	15
Figure 6. Three-Wire Transmitters Powered Externally	15
Figure 7. Flow Meter Pulse Input Connections.....	16
Figure 8. Digital Input From Switch Closure	16
Figure 9. Digital Input From Live Signal.....	16
Figure 10. 4-20 mA Output Powered by ConsoliDator	17
Figure 11. 4-20 mA Output Powered by External Supply.....	17
Figure 12. Relay Connections	18
Figure 13. AC and DC Loads Protection.....	18
Figure 14. Low Voltage DC Loads Protection	18
Figure 15. Serial Connections	19
Figure 16. External Keypad Connections.....	20
Figure 17. Linear Response Graph	25
Figure 18. Square Root Response Graph.....	26
Figure 19. Exponent Response Graph.....	27
Figure 20. Pulse Relay Timing Diagram	33
Figure 21. Linear PWM Relay Timing Example.....	38
Figure 22. PD980 & PD940 Overall Dimensions.....	54
Figure 23. PD981 & PD941 Overall Dimensions.....	54

SPECIFICATIONS

Except where noted all specifications apply to operation at +25°C (77°F.)

General

DISPLAY	Graphical: 4.75" x 3.5" (121 mm x 89 mm) LCD with backlight 320 X 240 pixels; Bargraph: Twenty divisions; Numerical: ±999999 or 99' 11.9" (feet and inches)
DISPLAY UPDATE RATE	1 every 2 seconds
PROGRAMMING METHOD	Front panel buttons, external buttons, PC with ConsoliDator software, or Modbus registers.
CALIBRATION	All ranges are calibrated at the factory.
PASSWORD	Programmable password restricts modification of programmed settings and use of manual control functions.
NON-VOLATILE MEMORY	Settings stored for a minimum of 10 years.
POWER	AC: 90-264 VAC, 47 to 63 Hz, 20 VA DC: 8-30 VDC, 15 W
FUSE	AC: Unit is protected internally. 5 A max, slow blow, 250 V min UL Recognized external fuse recommended. DC: 5 A max, slow blow, 250 V (or 50 V min) UL Recognized external fuse recommended.
ISOLATION & GROUNDING	AC power is isolated from all inputs, outputs and relays to 1500 VAC. Isolation to 500 VAC between analog inputs and analog outputs requires powering analog outputs with external supply. Signal and output power grounds are connected to earth (chassis) ground. DC Power not isolated.
ENVIRONMENTAL	Operating temperature range: 0 to 50°C (32 to 122°F) Storage temperature range: -40 to 60°C (-40 to 140°F) Relative humidity: 0 to 90% non-condensing <i>*All functions operate down to -10°C (14°F.) LCD response is slower below 0°C (32°F) and may need contrast adjustment to be readable.</i>
CONNECTIONS	Removable screw terminal blocks accept 12 to 24 AWG wire. DB9 male for serial connection.
TIGHTENING TORQUE	Screw terminal connectors: 4.5 lb-in (0.5 Nm)
ENCLOSURE	Type 1; Powder-coated steel; Color: warm gray
MOUNTING	Wall Mount (PD980 & PD940): four screws/bolts Panel Mount (PD981 & PD941): four screws/bolts Cutout: 7.37" x 8.35" (187 mm x 212 mm)
OVERALL DIMENSIONS	Wall Mount 8.75" x 8.00" x 3.00" (222 mm x 203 mm x 76 mm) (H x W x D) Panel Mount 8.66" x 9.36" x 3.10" (220 mm x 238 mm x 79 mm) (H x W x D)
WEIGHT	5.5 lb (2.5 kg)
WARRANTY	1 year parts and labor
EXTENDED WARRANTY	1 or 2 years, refer to Price List for details

4-20 mA Analog Inputs

INPUT	4-20 mA; minimum span of 1 mA
ACCURACY	±0.03% of span ±1 count
TEMPERATURE DRIFT	50 PPM/°C from 0 to 50°C ambient
INPUT FUNCTION	Linear, Square Root, Programmable Exponent, Multi-Point (up to 32), or Fixed Value
MATH FUNCTION	Sum or difference of 2 or more channels.
TOTALIZER	Calculates total based on rate and time base of second, minute, hour, or day; stored in non-volatile memory every 5 minutes; supports linear inputs only.
TOTALIZER RESET	Via front panel buttons (password restricted)
DECIMAL POINT	User selectable zero to six places with automatic overflow.
INPUT RANGE	4-20 mA, Minimum span of 1 mA
INPUT IMPEDANCE	130 Ω
NORMAL MODE REJECTION	Greater than 100 dB at 50/60 Hz.
TRANSMITTER POWER SUPPLY	Each input is equipped with +24 VDC current limited to 40 mA. External supply may be substituted.
ENGINEERING UNITS	User selectable units or custom-entered units.

Flow Meter Pulse Inputs

ACCURACY	±1 count for K-Factor > 1
SIGNAL RANGE	100 mVp-p to 15 Vp-p; 1 Hz to 10 kHz
K-FACTOR	Programmable from 0.00001 to 999999 pulses/unit
DISPLAY OPTIONS	Rate and total values displayed on screen. Bargraphs user selectable to indicate either total or rate.
ENGINEERING UNITS	Show Total/Rate combinations: GAL & GPS, GAL & GPM, GAL & GPH, GAL & GPD, MG & MGD, BBL & BPH, BBL & BPD, LTR & LPS, LTR & LPM, LTR & LPH, LTR & LPD, CF & CFS, CF & CFM, CF & CFH, CF & CFD, MCF & MCD.
RATE & TOTAL DECIMAL POINT	Independent and user selectable from zero to six places with automatic overflow.
TOTALIZER	Calculates total based on rate. Reading stored in non-volatile memory every 5 minutes for power-loss recovery.
TOTALIZER RESET	Via front panel buttons (Password restricted)

Digital Inputs

INPUT TYPES	Normally open switch: External excitation not required. Open collector transistor: Open circuit voltage = 3 VDC Closed Circuit Current = 18.5 mA Switch closure or logic LO to terminals interpreted as "ON" LO = 0 to 1 VDC, HI = 2.5 to 12 VDC
INPUT IMPEDANCE	240 Ω
SIGNAL REQUIREMENTS	Minimum input pulse (closed contact or LO) duration: 1 sec Maximum input pulse frequency: 30 cycles per minute

Relays

RATING	SPDT (form C); rated 10 A @ 120/240 VAC or 5 A @ 28 VDC resistive load; 1/3 HP @ 120/240 VAC for inductive loads. Minimum load: 50 mA for AC, 10 mA @ 5 VDC
ISOLATION	1500 VAC between coil and contacts
DEADBAND	0-100% of full scale, user selectable
ELECTRICAL NOISE SUPPRESSION	An external suppressor (snubber) should be connected to each relay contact switching inductive loads, to prevent disruption to the microprocessor's operation. Recommended suppressor value: 0.01 μ F/470 Ω , 250 VAC (Order: PDX6901.)
ASSIGNMENT & OPERATION	<p>Any relay may be assigned to any analog or flow meter pulse input channel. Multiple relays may be assigned to the same channel. All relays are programmed independently.</p> <p>High or Low Alarm: Assign to analog or pulse channel for on/off relay control.</p> <p>Multi-Channel High or Low Alarm: Assign two or more analog channels. Indicate common high or low condition.</p> <p>Annunciator High or Low: Assign to analog or pulse channel for on/off relay control with reset capability from digital input switch.</p> <p>Summary Alarm: Use to indicate any relay entering alarm state.</p> <p>Supervisory Alarm: Use to indicate CPU failure or analog input signal loss.</p> <p>High or Low Pulse Action: Assign to analog or pulse input channel for pulsing on/off timed relay control. Programmable pulse width and delay.</p> <p>Trigger: Assign to pulse channel for indication of user-defined total increment. Programmable for scaled pulse output.</p> <p>Plunger Lift: Assign to analog and/or pulse channels to control a plunger lift system.</p> <p>Lead-Lag Alternation (Sequence): Link multiple relays for sequential operation. (Up to 9 relays.) Programmable override set points to turn on up to 5 relays.</p> <p>Pulse Width Modulation: Assign to analog or pulse channel for on/off signal modulated by input. User selectable cycle time.</p> <p>PI Control: Assign to analog or pulse channel for Proportional plus Integral on/off modulated duty cycle. Manual tuning required.</p>
MANUAL OVERRIDE	Override any relay (Password restricted.) Relays do not respond to input in this mode.
ACKNOWLEDGE	Front panel ACK key resets relays in <i>Supervisory, Summary and Annunciator Alarm Modes</i> .
TIME DELAY	Programmable on/off delays, 0-999.9 sec Independent for each relay.
AUTO INITIALIZATION	When power is applied to the controller, relays will reflect the state of the input to the controller.

4-20 mA Transmitter Outputs

OUTPUT RANGE	4.00 to 20.00 mA
CALIBRATION	Factory calibrated for 4-20 mA
SCALING RANGE	Any process range.
ASSIGNMENT & OPERATION	Assign to any analog or pulse input channel for linear scaling or for manually tuned PID control output.
ACCURACY	±0.05% F.S. ±0.01 mA
TEMPERATURE DRIFT	50 PPM/°C from 0 to 50°C ambient. Output & Input drifts are separate.
OUTPUT LOOP POWER	Self powered or externally powered by 12 to 32 VDC
OUTPUT LOOP RESISTANCE	Powered by controller: 10 to 600 Ω Powered by external 12 VDC: 10 to 300 Ω Powered by external 24 VDC: 10 to 600 Ω Powered by external 32 VDC: 10 to 900 Ω
ISOLATION	1500 V output-to-power line; 500 V output-to-input when powered by external supply.

Modbus[®] Serial Communications

COMPATIBILITY	EIA-232
PROTOCOL	Modbus RTU
DEVICE ADDRESS	Programmable between 1 and 247
TRANSMIT DELAY	Programmable between 0 and 300 ms
BAUD RATE	Programmable from 1200 to 38400
DATA	8 bit (1 start bit, 1 stop bit)
PARITY	EVEN, NONE with 1 stop bit, or NONE with 2 stop bits.



ConsoliDator[®] Software

SYSTEM REQUIREMENTS	Windows [®] 95/98/ME/NT4/2000/XP
COMPATABILITY	Separate versions for ConsoliDator 4 and ConsoliDator 8.
COMMUNICATION	RS-232 using null-modem serial cable.
LOGGING REPORTS	Programmable between 1 sec. and 10 min.
LOGGING REPORT	Log to comma separated value (.csv) file compatible with spreadsheet applications such as Microsoft [®] Excel.
CONFIGURATION	Configure inputs and outputs. Store ConsoliDator settings file on PC for programming other controllers or restoring settings.

Compliance Information

UL LISTED	USA and Canada: UL 508 Industrial Control Equipment
UL FILE NUMBER	E160849

SAFETY INFORMATION

	
CAUTION: Read complete instructions prior to installation and operation of the controller.	WARNING: Risk of electric shock.

**WARNING**

Hazardous voltages present. Installation and service should be performed only by trained service personnel.

INSTALLATION

Unpacking

Remove the instrument from its box. Inspect the packaging and contents for damage. Report any damages to the carrier. If any part is missing or the controller malfunctions, please contact your supplier or the factory for assistance.

Wall Mounting

(For PD980 & PD940 Models)

- Obtain four #10 (M5) screws and nuts.
- Prepare four 1/4" (6 mm) holes through mounting surface spaced as shown.
- Allow at least 2" (5 mm) of free space on all sides so that the removable screw terminals and DB9 connector may be accessed for wiring.
- Secure instrument to surface.

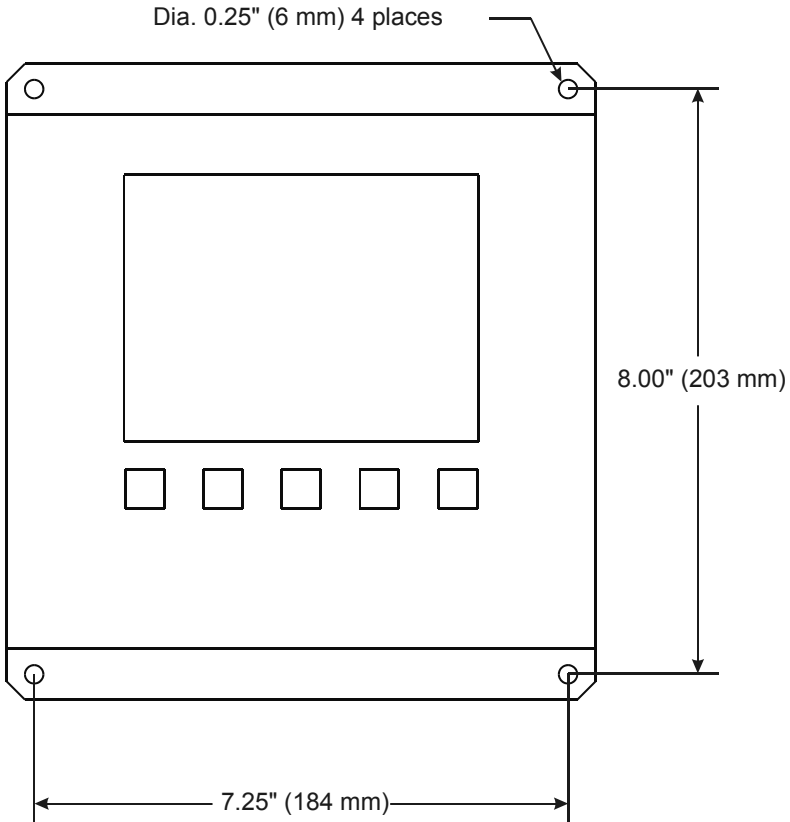

Figure 1. Wall Mount Dimensions (PD980 & PD940)

Panel Mounting

(For PD981 & PD941 Models)

- Obtain four #8 (M4) screws and nuts.
- Obtain four washers with at least 5/16" (8 mm) O.D. If the device will be subjected to vibration, lock washers are necessary.
- Prepare four 1/4" (6 mm) clearance holes through mounting surface spaced as shown.
- Prepare panel cutout.
 - 8.35" W x 7.37" H (212 mm x 187 mm)
 - Center cutout vertically and horizontally with respect to holes.
 - Maximum allowable inner radii: 0.1" (2.5 mm.)
- Remove all connectors.
- Insert controller and secure to surface.

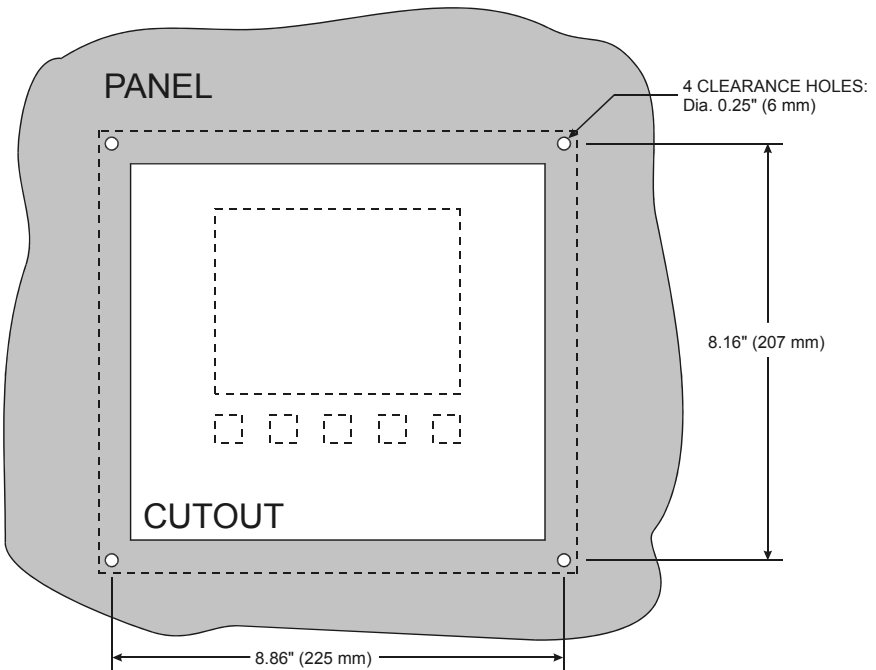
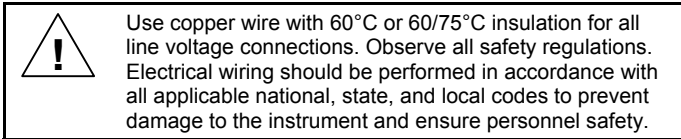

Figure 2. Panel Mount Dimensions (PD981 & PD941)

Connections

Connections are made to removable screw terminal connectors and a DB9 male serial connector. They are located around the sides of the controller.



Power Connections

Power connections are made to one of the power terminal connectors. All units are capable of being powered either by AC or by DC for the ranges specified.

CONNECT ONLY ONE OF THE POWER INPUTS

120-250 VAC Power (90 VAC min, 264 VAC max)

- Use three-terminal power connector as shown in **Figure 3**.
- Unit is protected internally. 5 A max, slow blow, 250 V min UL Recognized external fuse recommended.

8-30 VDC Power

- Use two-terminal power connector as shown in **Figure 3**.
- 5 A max, slow blow, 250 V (or 50 V min) UL Recognized external fuse recommended.

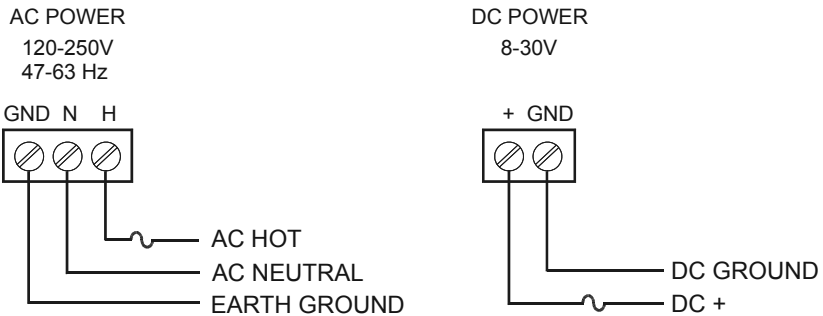

Figure 3. Power Connections

Input Signal Connections

Input signal connections are made to terminal connectors, which are labeled individually on the controller.

4-20 mA Analog Input Connections

Analog 4-20 Input connections are made to three-terminal connectors. The following figures show examples for typical applications. Each of the 4-20 mA inputs may be connected in any of the modes shown below.

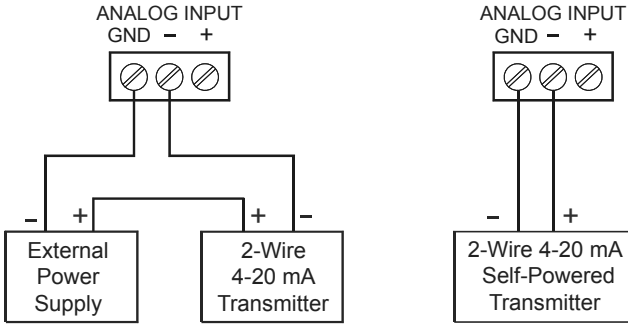

Figure 4. Transmitter Powered by Ext. Supply or Self-Powered

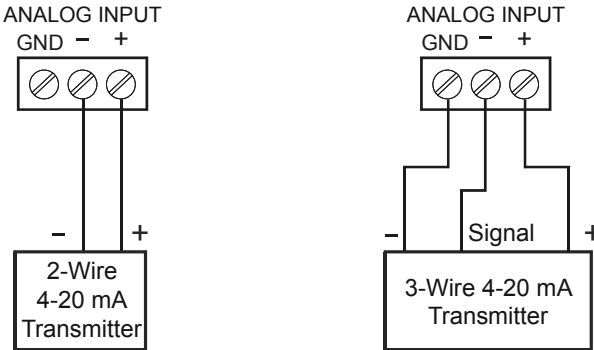

Figure 5. Transmitters Powered by ConsoliDator

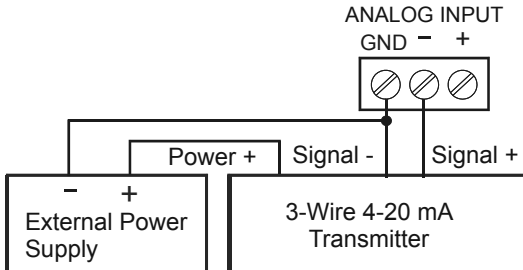

Figure 6. Three-Wire Transmitters Powered Externally

Flow Meter Pulse Input Connections

Flow Meter Pulse Inputs are wired to two-terminal connectors. A square waveform is used in the illustration, but the input is capable of reading many other types of signals within the voltage and frequency ranges specified.

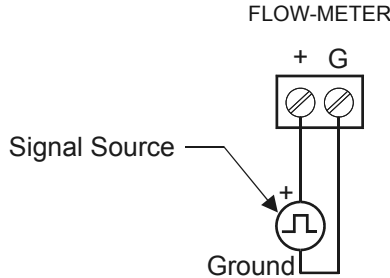

Figure 7. Flow Meter Pulse Input Connections

Digital Input Connections

Digital Inputs are wired to two-terminal connectors. Normally open switch contacts may be used as shown in **Figure 8**. **Figure 9** shows a Digital Input using an NPN open collector transistor output from a live signal. Logic LO or switch closure appearing across the terminals is interpreted as ON. When using an open collector transistor, a logic HI at the base (marked "B" in **Figure 9**) will be interpreted as ON.

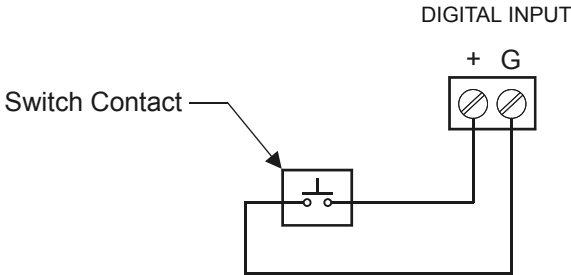

Figure 8. Digital Input From Switch Closure

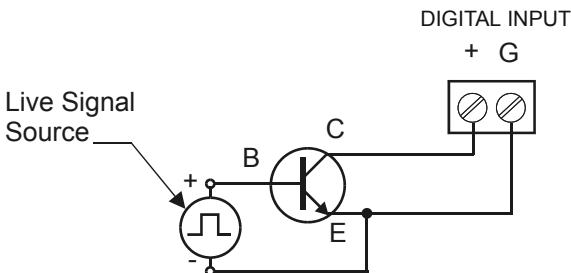

Figure 9. Digital Input From Live Signal

Analog Output Connections

The following figures show examples for 4-20 mA transmitter output connections. Terminal connectors are labeled individually on the side of the case. In order to obtain isolation from analog inputs, outputs must be powered from an external supply as shown in **Figure 11**.

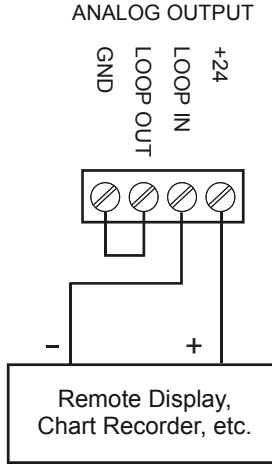

Figure 10. 4-20 mA Output Powered by ConsoliDator

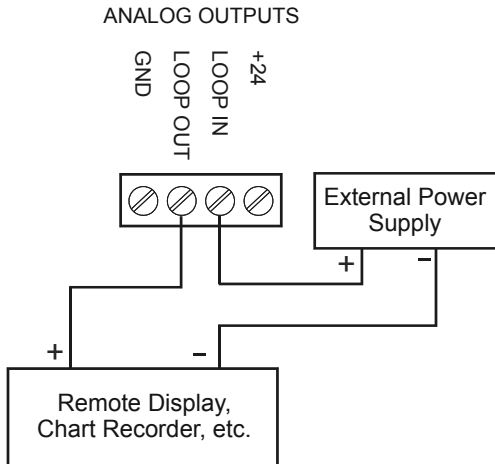

Figure 11. 4-20 mA Output Powered by External Supply

Note: All inputs and outputs share a common ground. **DO NOT** power inputs and outputs with the same power supply.

Relay Connections

Relay connections are made to three-terminal connectors labeled on the side of the case.

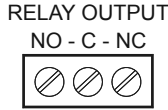

Figure 12. Relay Connections

Switching Inductive Loads

The use of suppressors (snubbers) is strongly recommended when switching inductive loads to prevent disrupting the microprocessor's operation. The suppressors also prolong the life of the relay contacts. Suppression can be obtained with resistor-capacitor (RC) networks assembled by the user or purchased as complete assemblies. Refer to the following circuits for RC network assembly and installation:

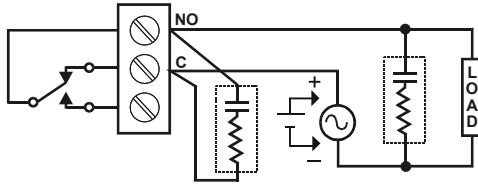

Figure 13. AC and DC Loads Protection

Choose R and C as follows:

R: 0.5 to 1 Ω for each volt across the contacts

C: 0.5 to 1 μF for each amp through closed contacts

Notes:

1. Use capacitors rated for 250 VAC.
2. RC networks may affect load release time of solenoid loads. Check to confirm proper operation.
3. Install the RC network at the instrument's relay screw terminals. An RC network may also be installed across the load. Experiment for best results.

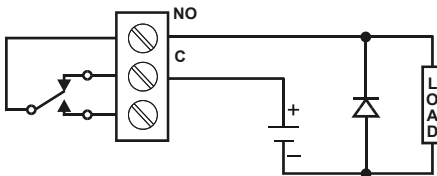

Use diode with a reverse breakdown voltage two to three times the circuit voltage and forward current at least as large as the load current.

Figure 14. Low Voltage DC Loads Protection

RC Networks Available from Precision Digital

RC networks are available from Precision Digital and should be applied to each relay contact switching an inductive load. Part number: PDX6901.

Serial Communication Connections

A DB9 male connector is the port for RS-232 serial communication (using Modbus protocol.) The ConsoliDator can be connected to Data Circuit-Terminating Equipment (DCE) such as a radio transmitter with a regular straight-through serial cable. In cases where connecting to Data Terminal Equipment (DTE), such as a PC, a Female-Female Null Modem cable is necessary. Many computers are equipped with at least one 9-pin RS-232 serial port. For distances up to 50 ft, a shielded serial or null-modem cable is adequate. More information can be found in **Modbus Serial Communications** (page 47)

When connecting the ConsoliDator® to a PC via the PDA8232, it is strongly recommended to change the ConsoliDator's parity parameter to "NONE - 8N2," for None parity, 2 stop bits.

A null modem cable looks similar to a standard serial cable, but internally the transmit and receive lines cross unlike in a standard serial cable and for Computer-to-ConsoliDator, both ends must be Female.

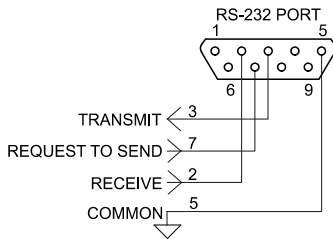

Figure 15. Serial Connections

Serial Communication Using RS-422/485

For long distances or noisy environments RS-422 and RS-485 offer superior performance compared to RS-232. Differential signals can help nullify the effects of ground shifts and induced noise signals that can appear as common mode voltages on a network. RS-422 was designed for greater distances than RS-232. In its simplest form, a pair of converters from RS-232 to RS-422 (and back again) can be used to form an "RS-232 extension cord." Distances to 4000 ft. can be reached with RS-422.

In an application that requires more than two devices to be networked, the RS-232 data must be converted to a serial format that allows for multiple devices, such as RS-485. For example, you can connect two or more ConsoliDators to a single computer by converting all devices to RS-485, but only one ConsoliDator with RS-232.

Data Converters Available from Precision Digital

Serial converters available from Precision Digital support a wide range of devices. Please reference part number PDA7485 when requesting information.

External Keypad Connections

Normally open pushbuttons may be wired to the six-terminal external keypad connector for use when the front panel of the controller is not accessible. Keys 1 through 5 refer to the front buttons in order from left to right.

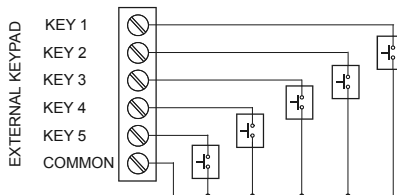

Figure 16. External Keypad Connections

NAVIGATING AND EDITING

The device displays various screens throughout programming and operation. Functions are programmed within their respective menu screens in many cases accompanied by user prompts.

Soft-Keys and Buttons

The unit is equipped with five buttons located below the display. The function of each button corresponds to its soft-key, which appears at the bottom of the screen. Buttons assume different functions, which change according to the screen in view.



Selections are marked by a cursor, which appears on screen as an arrowhead. The keys below are used to navigate through menus and edit settings. Other special keys appear throughout the programming process.

Key	Action
ACK	<ul style="list-style-type: none"> Acknowledge relay(s)
EDIT	<ul style="list-style-type: none"> Modify selection
ENTER	<ul style="list-style-type: none"> Execute current selection
EXIT	<ul style="list-style-type: none"> Quit present screen or mode
MANUAL / AUTO	<ul style="list-style-type: none"> Toggle operation modes
RST	<ul style="list-style-type: none"> Reset total
SAVE	<ul style="list-style-type: none"> Store setting to memory
SETUP	<ul style="list-style-type: none"> Enter main setup menu
SIM	<ul style="list-style-type: none"> Enter simulation mode
NEXT	<ul style="list-style-type: none"> Scroll through operation screens
↑	<ul style="list-style-type: none"> Move cursor up when navigating menus Scroll up through characters & values when editing settings
↓	<ul style="list-style-type: none"> Move cursor down when navigating menus Scroll down through characters & values when editing settings
→	<ul style="list-style-type: none"> Move cursor right when navigating menus Move to next character space when editing settings
+	<ul style="list-style-type: none"> Increase setting
-	<ul style="list-style-type: none"> Decrease setting

SETUP AND PROGRAMMING

There is **no need to recalibrate** the instrument when first received from the factory.

The device is **factory calibrated** prior to shipment, for all input types. The calibration equipment is certified to NIST standards.

Overview

Setup and programming are done through the front buttons or ConsoliDator Monitor Software. After power and signal connections have been completed and verified, apply power to the instrument.

Inputs, outputs, and relays are configured individually. It is recommended that all inputs be configured before outputs and relays are programmed.

Shown to the right is a typical screen that appears upon first power-up. Actual screens will vary with the amount of inputs initially detected.

For information on button functions, see **NAVIGATING AND EDITING** (page 20.)

To load software and program from a PC, please familiarize yourself with the **ConsoliDator Monitor Software** (page 52) before you continue with device setup.

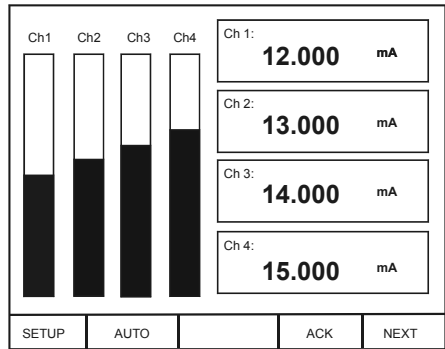

Press **SETUP** key to begin.

Main Setup Menu

The main setup menu is the access point during the programming process for setting up *Inputs*, *Outputs*, and *General Functions*. The number of inputs and outputs shown on this screen are determined by what your particular model is equipped with.

Use arrows to navigate and the **ENTER** key to select.

<p>Inputs</p> <ul style="list-style-type: none"> ▶ Channel #1 Channel #2 Channel #3 Channel #4 Channel #5 Channel #6 Channel #7 Channel #8 Flow Meter #1 Flow Meter #2 Flow Meter #3 Flow Meter #4 	<p>Outputs</p> <ul style="list-style-type: none"> Alarm Relay #1 Alarm Relay #2 Alarm Relay #3 Alarm Relay #4 Alarm Relay #5 Alarm Relay #6 Alarm Relay #7 Alarm Relay #8 Alarm Relay #9 Analog Out #1 Analog Out #2 			
<p>General Functions</p> <p>Buzzer: <input type="checkbox"/> ON <input checked="" type="checkbox"/> OFF</p> <p>T-Out: <input type="checkbox"/> ON <input checked="" type="checkbox"/> OFF</p> <p>Change Password</p> <p>Save BL: <input type="checkbox"/> YES <input checked="" type="checkbox"/> NO</p> <p>Baud Rate: 19200 bps</p> <p>Parity: EVEN - RE1</p> <p>Modbus ID: 1</p> <p>Tx Delay: 0 ms</p> <p>Adjust Contrast</p>				
↓	↑	→	ENTER	EXIT

Inputs

The *Inputs* box shown on this screen lists the 4-20 mA Channels and Flow Meter inputs. Individual channel setup is covered in detail in the next sections: **Configuring 4-20 mA Input** (page 24) and **Setting Flow Meter Pulse Inputs** (page 30.)

Outputs

The *Outputs* box shown on this screen lists the relay and analog output channels available. Output setup is covered in **Programming Relays** (page 31) and **Setting 4-20 mA Outputs** (page 40.)

General Functions

The *General Functions* box contains various options and serial communication settings.

If you are beginning a first-time setup, please read the brief descriptions below and if you are not sure of the settings, you may skip them and return after the controller's operation is explained in later sections.

Use the arrows keys to move cursor to parameters in the *General Functions* box. Use **ENTER** to select a parameter.

Buzzer

Buzzer sounds to indicate an active relay if [ON] is selected. Select [OFF] to disable.

Time Out

Manual mode time-out options are related to **Manual and Simulation Modes** (page 45.) When *T-Out* is set to [ON] the controller will return to Automatic mode after being left alone for 5 minutes in Manual mode. When [OFF] is selected, the controller will only switch modes if a key is pressed and then the password (if enabled) is entered.

Password

Select [Change Password] to enter a new password up to ten characters or to change an existing password. The operator will be required to enter this password to access setup or to manually override relays. It is recommended to enter the password after setup and programming is completed.

To disable a previously programmed password: Enter setup, select [Change Password] and leave the *Password* entry box blank.

Backlight

Selecting [YES] under Save BL automatically turns the backlight off if no buttons are pressed for five minutes. This is recommended unless it is necessary to have the backlight constantly on. When [NO] is selected the backlight is always on.

Baud Rate

Select any available baud rate.

Parity

Select [EVEN – 8E1] for Even parity, 1 stop bit.
Select [NONE – 8N2] for None parity, 2 stop bits.
Select [NONE – 8N1] for None parity, 1 stop bit.

Modbus ID

Specify an address for Modbus communication.

Tx Delay

Specify a serial data transmission delay (response.)

Place cursor at the channel you want to set and press **ENTER**.

Configuring 4-20 mA Inputs

The Analog Input setup screen is used to configure the 4-20 mA analog inputs. Each channel has a separate menu. All 4-20 mA inputs can be configured using the information provided in this section. In this menu, the *Sensor* box displays the live input reading in mA, and the *Value* box displays the scaled engineering units corresponding to the sensor input. You can verify your scaling parameters with this relationship.

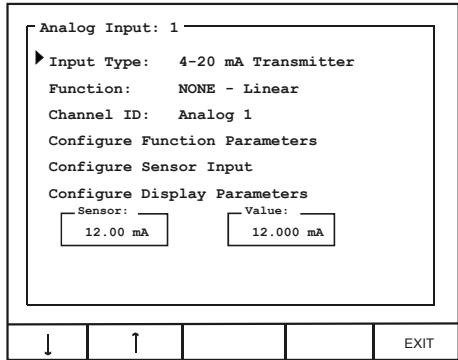

Display Preferences

Begin configuring the input by naming the channel (e.g. "Tank 1".) This name appears on screen to identify the channel during operation.

Move cursor to *Channel ID* and press **EDIT**. Use arrow keys to scroll through characters and move to the next position. Press **SAVE** to store new setting to memory.

Next, set display options. Move cursor to *Configure Display Parameters* and press **ENTER**. The box that appears contains the parameters for decimal point, engineering units, and bargraph extents for this channel. Use **EDIT** and arrow keys. Remember to press **SAVE** when finished.

Decimal Point

Format specifies the decimal point position for this channel. Use the arrow keys to shift left or right (zero to five places.)

Units

Select from any available engineering units or choose to enter a combination of characters by pressing the **CUSTOM** key. If this channel is to be used for integration totalizing, do not select rate units as the integration time base is added separately.

Bargraph

Max Value and *Min Value* are used to set the span of the bargraph (in scaled engineering units) for this channel. The bargraph will appear 100% full at *Max Value* and 0% at *Min Value*.

Input Scaling & Math Functions

The ConsoliDator is capable of various functions for scaling the 4-20 mA inputs. *Linear Square Root*, *Programmable Exponent*, and *Integration* are two-point scaling functions. *Multi-Point* is capable of handling up to 32 scaling points and requires that the ConsoliDator Monitor Software be used to enter these points.

Linear

Linear mode refers to basic 2-point scaling of a 4-20 mA signal in engineering units. The graph in **Figure 17** shows the display response based on example scaling parameters. For this mode select [Linear] from *Function* options, then follow **Sensor Input Setup** (page 29) to enter your scaling parameters.

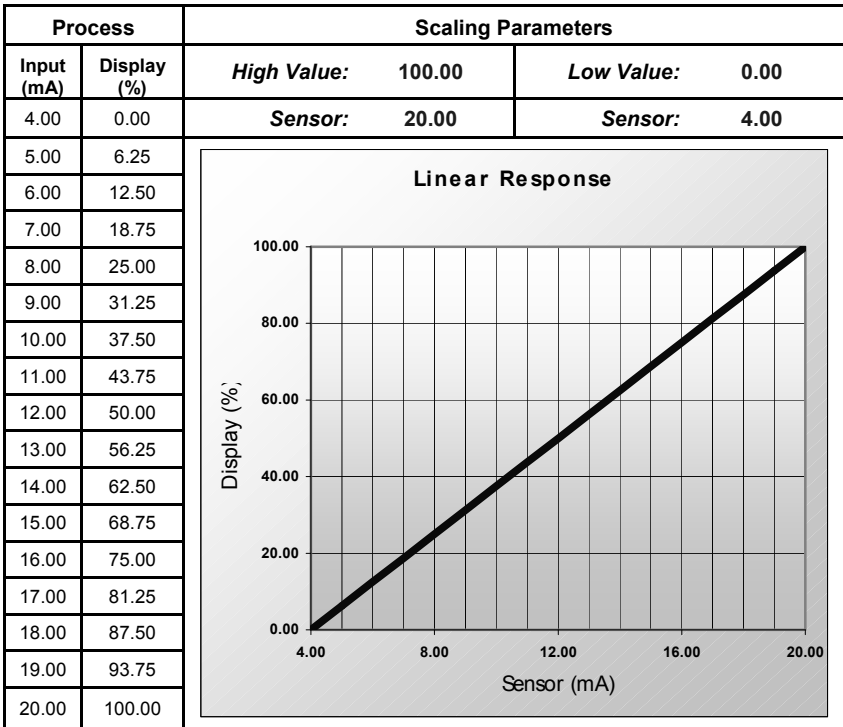

Figure 17. Linear Response Graph

Square Root

Square root mode refers to 2-point scaling with square root extraction typically used to linearize the signal from a differential pressure transmitter and display the flow rate in engineering units. The graph in **Figure 18** shows the display response based on example scaling parameters. For this mode select [Square Root] from Function options.

The square root mode supports low-flow cutoff which can be used to suppress readings below a programmed value. Below the cutoff value, the controller will display "0". To enter a cutoff value, select *Configure Function Parameters*. Press **EDIT** and use arrow keys to change the value. Press **SAVE** when complete.

Follow **Sensor Input Setup** (page 29) to enter your scaling parameters.

Note: An input that goes below the *Low Value* parameter results in a display of "-999999" indicating underrange condition. This can be prevented using the cutoff feature.

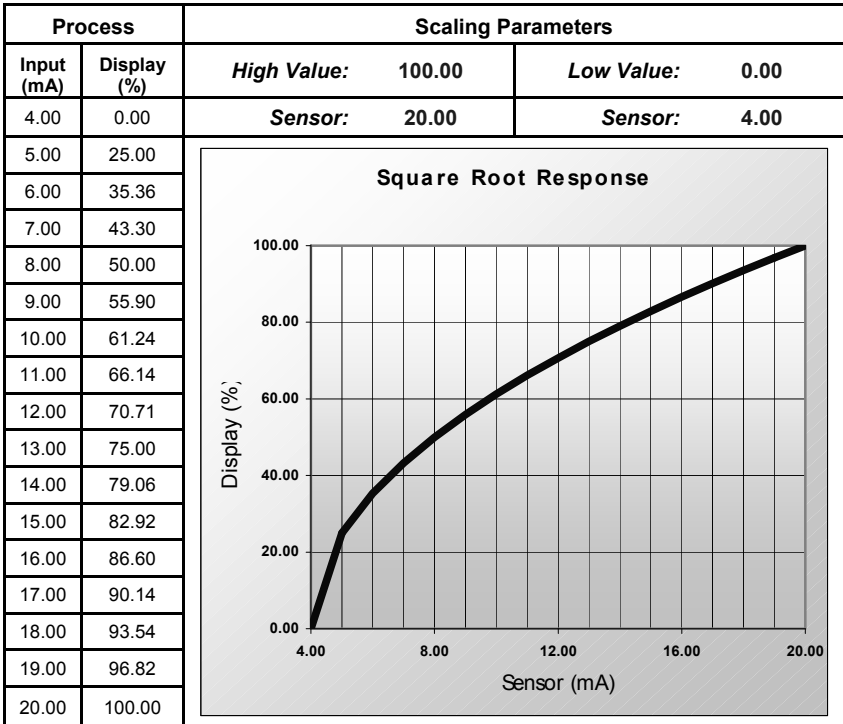

Figure 18. Square Root Response Graph

Exponent

Exponent mode refers to 2-point scaling with programmable exponent (programmable root) extraction typically used in open-channel flow applications with weirs and flumes to linearize the signal from a level transmitter and display the flow rate in engineering units. The graph in **Figure 19** shows the display response based on example parameters and exponent of “1.5”. For this mode select [Exponent] from *Function* options. To enter an exponent, select *Configure Function Parameters*. Press **EDIT** and use arrow keys to change the value. Press **SAVE** when complete.

The exponent mode supports low-flow cutoff which can be used to suppress readings below a programmed value. Below the cutoff value, the controller will display “0”. To enter a cutoff value, select *Configure Function Parameters*. Press **EDIT** and use arrow keys to change the value. Press **SAVE** when complete.

Follow **Sensor Input Setup** (page 29) to enter your scaling parameters.

Note: An input that goes below the *Low Value* parameter results in a display of “-999999” indicating underrange condition. This can be prevented using the cutoff feature.

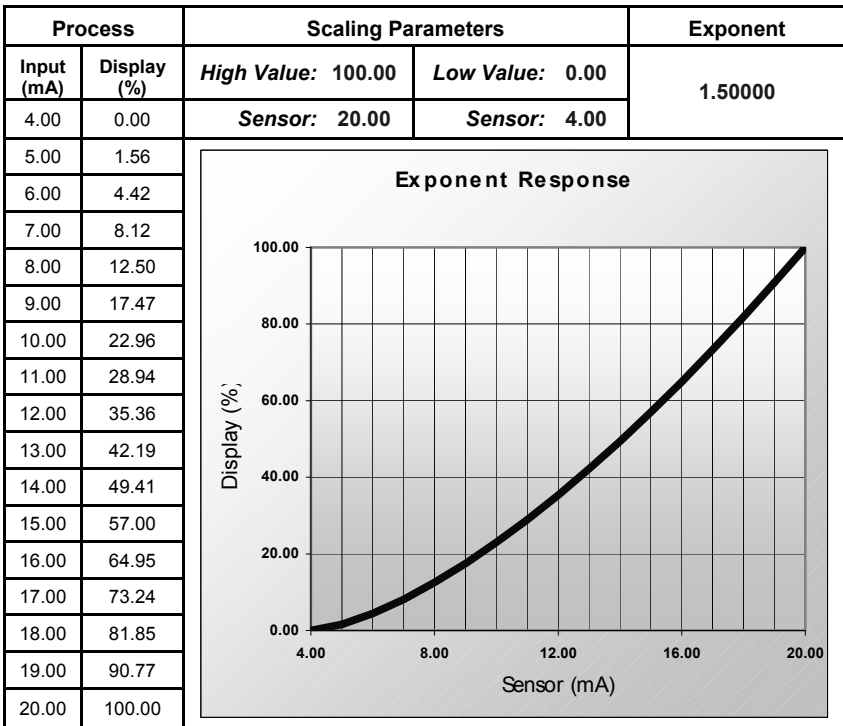

Figure 19. Exponent Response Graph

Integration Mode

Integration mode is able to totalize from any 4-20 mA channel over a time base of second, minute, hour, or day. During operation, the channel's display screen shows bargraph total, numeric total, and numeric rate. To begin setup, select from the following under *Function* options [Integration: SEC], [Integration: MIN], [Integration: HOUR], or [Integration: DAY]. Follow **Sensor Input Setup** (page 29) to enter your scaling parameters for the rate.

Note: Integration Mode is available for 2-point linear calibration only.

Fixed Value

Fixed Value mode may be used to create a constant display as if a steady signal is applied to the input, without requiring a transmitted signal. Controller outputs assigned to this channel will respond the same way it would with a constant signal. Any transmitted source connected on the corresponding input is ignored while fixed value mode is selected. To begin setup, select [Fixed Value] from *Function* options. Next, select *Configure Function Parameters*. In the box that appears, enter a value in engineering units by pressing **EDIT** and using the arrow keys. Press **SAVE** when complete and then **EXIT** to return to input menu.

Summation & Difference

Summation mode begins with a linearly scaled input, but adds the ability to *link* one or more separate channels for addition to its own display. Difference mode follows the same *link* principle, but subtracts one or more channels from itself. During operation, the channel that is used to set-up the *link* is the one that displays the sum or difference. Verify the appropriate channel has been selected. i.e. To display a summation for Channel 1 plus another channel, make sure you are in *Analog Input: 1* setup screen. Remember to scale the other channels that you have chosen to link.

First, enter your scaling parameters. Reference **Sensor Input Setup** (page 29.)

For Summation, select [Summation], from *Function* options. Select *Configure Function Parameters* from the Analog Input setup screen. In the *Function Setup* box shown to the right, use arrow keys and **ON/OFF** key to select channels to be linked. The settings shown in the screen to the right are programmed to add Channel 2 to Channel 1.

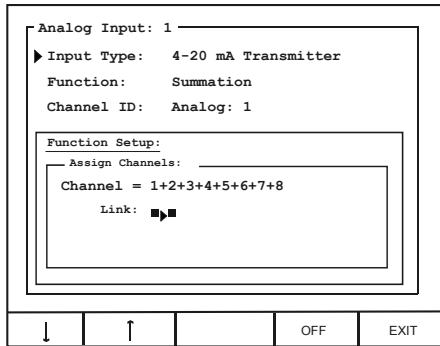

For Difference, select [Difference], from *Function* options. Select *Configure Function Parameters* from the Analog Input setup screen. In the *Function Setup* box shown to the right, use arrow keys and **ON/OFF** key to select channels to be linked. The settings shown in the screen to the right are programmed to subtract Channel 2 from Channel 1.

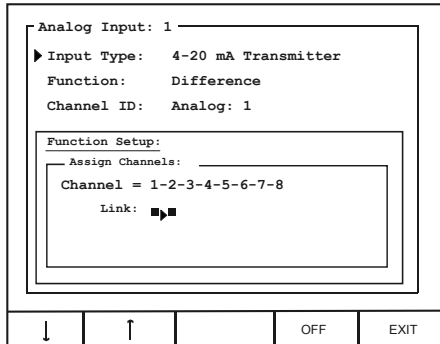

Multi-Point Linearization

Multi-Point Linearization must be configured using a PC and supplied ConsoliDator Monitor Software. After communication has been established between PC and ConsoliDator, select **System Settings** from the software’s menu bar. Next, select a channel to set up from the *Analog Input Channels* drop-down menu and press **Edit Channel**. Select [Multi-Point Linearization] from *Channel Function* drop-down menu. Use **Add**, **Edit**, and **Del** to manipulate the *Multi-Point Data Table*. Continue with other settings in this menu and press **Save** when complete. Reference **ConsoliDator Monitor Software** (page 52) for help setting up the PC connection.

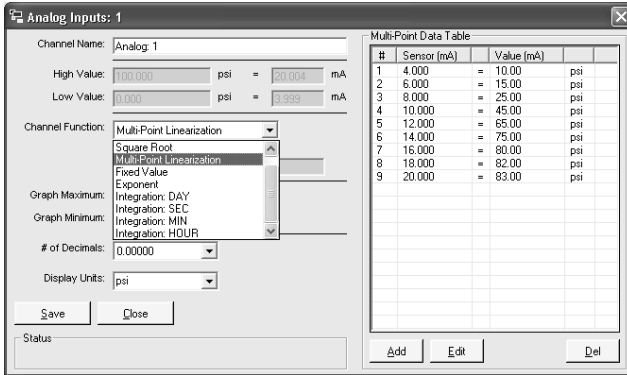

Sensor Input Setup

The simplest method is to assign low sensor input reading to a corresponding process value (zero point) and then assign a high sensor input reading to a corresponding process value (span.) The sensor input may be read from a live signal or entered manually.

1. Select *Configure Sensor Input*.
2. In the new box that appears move cursor to *Low Value* and press **EDIT**. Use the arrows to enter a process value associated with a low sensor point. Press **SAVE**.
3. Move cursor to *High Value* and press **EDIT**. Use the arrows to enter a process value associated with a high sensor point. Press **SAVE**.
4. Next, enter the *Sensor* points corresponding to the process values entered in (2)-(3) – for example: 4.00 mA and 20.00 mA. To read a live signal corresponding with the process value follow (a.) To enter a signal point manually follow (b.)
 - a. Verify connections and set transmitter to the appropriate level. Allow to settle for a few seconds. Position cursor at the *Sensor* parameter – located under the corresponding process value on the screen – and press **LIVE**.
 - b. To manually enter a signal level into the *Sensor* parameter corresponding to the process value entered in (2), position cursor in front of *Sensor* – located under *Low Value* on the screen – and press **EDIT**. Use the arrow keys to enter a sensor value in mA. Press **SAVE** when completed.
5. Verify entries and press **EXIT**.

Notes:
 1. Controller requires a minimum span of 1 mA.
 2. High and Low process values may be scaled in a negative direction for a decreasing process. For example: 100 gal High Value at 4 mA Sensor and 0 gal High Value at 20 mA Sensor.

Setting Flow Meter Pulse Inputs

The Flow Meter menu is used to configure a flow meter pulse input. All pulse input screens offer the same options as described in this section. Options are configured individually for each pulse input.

To access Flow Meter menu: Select a Flow Meter input from the *Inputs* window in the main setup menu.

To enter parameters in this menu, use **EDIT** key, then use arrow keys to modify the entries. Press **SAVE** when complete.

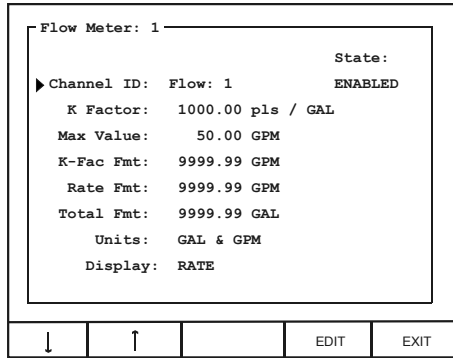

Display Parameters

<i>Channel ID</i>	Enter a name for the channel, which appears on the operation screens, and wherever else the channel is referenced.
<i>Max Value</i>	Specify the rate or total maximum. When this level is reached, the channel's bargraph will appear completely filled.
<i>Rate Fmt:</i>	Select a position for the rate display decimal point by shifting left or right (zero to five places.)
<i>Total Fmt</i>	Select a position for the total display decimal point by shifting left or right (zero to five places.)
<i>Units</i>	Select from any available unit combinations for flow.
<i>Display</i>	Set to display [RATE] or [TOTAL] based bargraphs during operation. This entry also determines whether assigned relay actions (other than Trigger Relay) are linked to rate or total values. The picture on page 43 shows a typical screen when set to display total.

Input Configuration Parameters

<i>State</i>	Enable or disable the input by selecting [ENABLED] or [OFF]. If a certain flow meter input is not going to be used, [OFF] must be selected.
<i>K Factor</i>	Specify the conversion factor "K" in pulses per unit.
<i>K-Fac Fmt</i>	Select a position for the K Factor decimal point by shifting left or right (zero to five places.)

Programming Relays

Each relay has an Alarm Setup menu used to program its functions. Functions are programmed individually for each relay except in the case of Lead-Lag mode. Each relay has the same available functions. All relays may be manually overridden. Before the relays are set up, verify that the inputs have been configured.

To access Alarm Setup menu: Select a relay from the *Relays* window in the main setup menu.

Use *Alarm Mode* setting to assign relay action. When a mode is selected, relay menu options change accordingly. If the relay will not be used, [OFF] should be selected.

Supervisory or Summary Alarm Modes

Select [Supervisory Alarm] from *Alarm Mode* options to turn relay on (energize) when a CPU failure is detected or if a process input is lost (no signal present.)

Select [Summary Alarm] from *Alarm Mode* options to turn relay on when any other relay enters alarm state.

High or Low Alarm Modes

High or Low functions are used to turn the relay on and off at selected process points. If it is necessary to have an external reset using a digital input channel or the **ACK** key select **Annunciator High or Low Alarm Modes** instead.

Select [HIGH] from *Alarm Mode* options to turn relay on (energize) when high set point is reached and off when low reset point is reached.

Select [LOW] from *Alarm Mode* options to turn relay on when low set point is reached and off when high reset point is reached.

Alarm Setup: 1				
▶ Alarm Mode:	HIGH			
Channel:	[1]	Analog:	1	
High Value:	16.00 mA			
Low Value:	8.00 mA			
Delay ON:	1.0	sec		
Delay OFF:	0.5	sec		
↓	↑		EDIT	EXIT

<i>Channel</i>	Assign the relay to any analog or pulse input.
<i>High Value</i>	Enter high process variable set/reset point.
<i>Low Value</i>	Enter low process variable set/reset point.
<i>Delay ON</i>	Enter the delay between when the set point is reached and the relay turns on (energizes.)
<i>Delay OFF</i>	Enter the delay between when the reset point is reached and the relay turns off (de-energizes.)

Multi-Channel High or Low Alarm Modes

Multi-Channel High or Low modes are used as an alarm triggered by a set point common to the linked channels.

Select [HIGH: Multi-Chan] from *Alarm Mode* options to turn relay on (energize) when high set point is reached by any linked channel, and off when all linked channels are below reset point.

Select [Low: Multi-Chan] from *Alarm Mode* options to turn relay on (energize) when low set point is reached by any linked channel, and off when all linked channels are above reset point.

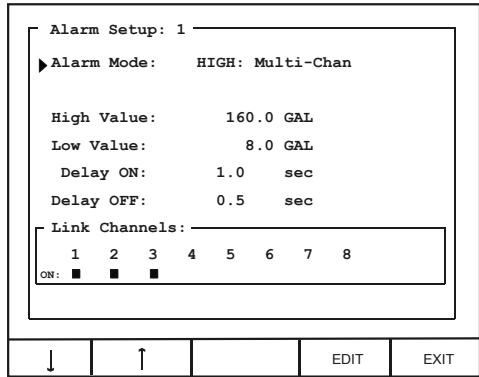

<i>Channel</i>	Assign the relay to any analog or pulse input.
<i>High Value</i>	Enter high process variable set/reset point.
<i>Low Value</i>	Enter low process variable set/reset point.
<i>Delay ON</i>	Enter the delay between when the set point is reached and the relay turns on (energizes.)
<i>Delay OFF</i>	Enter the delay between when the reset point is reached and the relay turns off (de-energizes.)
<i>Link Channels</i>	Select the channels to link .

High or Low Pulse Alarm Modes

Pulse Modes are used to generate an on/off continuous pulsing signal.

Select [HIGH: Pulse Mode] from *Alarm Mode* options to continuously pulse relay when high set point is reached. Pulsing stops when low reset point is reached.

Select [LOW: Pulse Mode] from *Alarm Mode* options to continuously pulse relay when low set point is reached. Pulsing stops when high reset point is reached.

Alarm Setup: 1

▶ Alarm Mode: HIGH: Pulse Mode

Channel: [1] Analog: 1

High Value: 16.00 mA

Low Value: 8.00 mA

Delay ON: 1.0 sec

Delay OFF: 0.5 sec

Pl. Width: 1.0 sec

Pl. Delay: 1.0 sec

↓
↑
OVER
EDIT
EXIT

- High Value* Enter high process variable set/reset point.
- Low Value* Enter low process variable set/reset point.
- Delay ON* Enter a delay between when the set point is reached and the pulse signal starts.
- Delay OFF* Enter a delay between when the reset point is reached and the pulse signal stops.
- Pl. Width* Enter pulse duration (Energized relay.)
- Pl. Delay* Enter duration between pulses (De-energized relay.)
- Over* Enter override menu to override the channel alarm settings.

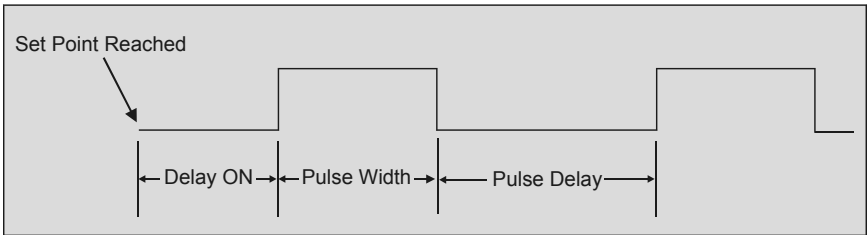

Figure 20. Pulse Relay Timing Diagram

Example Pulse Mode Scenario

The unit is set to the following:
Alarm Mode: [HIGH: Pulse Mode]
High Value: [16 mA]
Low Value: [10 mA]
Delay ON: [2 sec]
Delay OFF: [3 sec]
Pl. Width: [1 sec]
Pl. Delay: [2.5 sec]

The following describes operation based on the above settings:
 The process reaches 16 mA: 2 seconds pass with no relay action.
 Relay begins pulsing: on for 1 second, off for 2.5 seconds. ON-OFF alternation continues while the process is above 10 mA. The process reaches 10 mA: Pulse sequence continues for 3 seconds and then stops completely until 16 mA is reached again.

Trigger Alarm Mode

Select Trigger mode to pulse the relay once each time the total from a flow meter pulse input channel is incremented by a certain value.

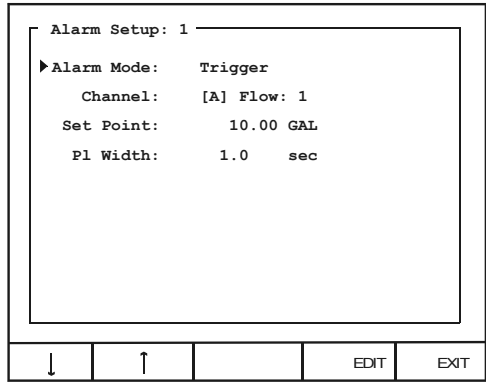

- Channel* Assign the relay to any flow meter pulse input.
- Set Point* Enter process variable set point. Each time the total increases by this value, the relay will be pulsed one time.
- Pl. Width* Enter duration for the relay to pulse on (energize.)

Annunciator High or Low Alarm Modes

The Annunciator functions are similar to High and Low Alarm Modes except for the addition of a reset capability from the **ACK** key, a digital input channel (normally open pushbutton switch), or External Key 4.

Select [ANNUNCIATOR: HIGH] from *Alarm Mode* options to turn relay on (energize) when high set point is reached and off when low reset point is reached.

Select [ANNUNCIATOR: LOW] from *Alarm Mode* options to turn relay on when low set point is reached and off when high reset point is reached.

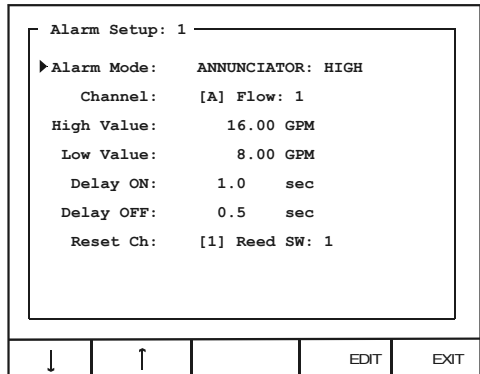

- Channel* Assign the relay to any analog or pulse input.
- High Value* Enter high process variable set/reset point.
- Low Value* Enter low process variable set/reset point.
- Delay ON* Enter the delay between when the set point is reached and the relay turns on (energizes.)
- Delay OFF* Enter the delay between when the reset point is reached and the relay turns off (de-energizes.)
- Reset Ch* Select a digital input channel to be used to reset the relay.

Plunger Lift by Differential Pressure Mode

Select [PLUNGER LIFT: DP] from *Alarm Mode* options to operate a plunger lift system that monitors differential pressure.

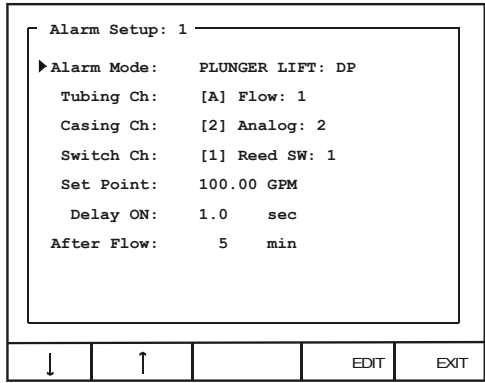

- Tubing Ch* Select a 4-20 mA input or pulse input (flow) as the tubing pressure or flow rate.
- Casing Ch* Select a 4-20 mA input or pulse input (flow) as the casing pressure or flow rate.
- Switch Ch* Select the channel that monitors a (pressure) switch input.
- Set Point* Enter the process variable point at which the relay closes a valve. The point may either be differential pressure or flow from a turbine meter.
- Delay On* Enter the time between when the set point is reached and the relay turns on (energizes.)
- After Flow* Enter a time long enough to guarantee that the plunger will fall to the bottom of the well.

Plunger Lift by Time Mode

Select [PLUNGER LIFT: TIME] from *Alarm Mode* options to operate a plunger lift system based on time by specifying the on and off durations in the cycle.

This mode may also be used as a general timer to cycle the relay on and off.

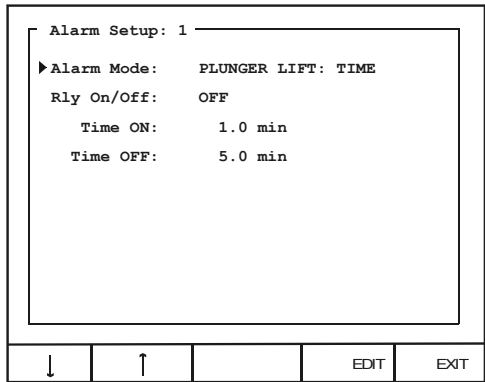

- Relay On/Off* Select [ON] to enable relay function or [OFF] to disable.
- TIME ON:* Enter relay-on duration.
- TIME OFF* Enter relay-off duration.

Lead-Lag Modes (Pump Alternation Control)

Lead-Lag modes are used to operate up to 9 relays in sequence. This mode is commonly used for pump alternation control. For example: If relays #1, #2, and #3 are linked in this menu, relay #1 turns on the first time the set point is reached and off when the reset point is reached, relay #2 cycles the second time, and relay #3 cycles the third time. The sequence then repeats beginning with relay #1.

Select [LEAD-LAG: HIGH] from *Alarm Mode* options to turn relay on when high set point is reached and off when low reset point is reached.

Select [LEAD-LAG: LOW] from *Alarm Mode* options to turn relay on when low set point is reached and off when high reset point is reached.

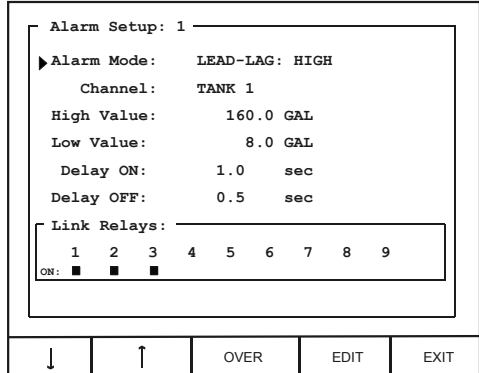

Note: Linked relays must be set to [OFF] in their respective menus. (i.e. If Alarm Setup 1 links Relay #2, Alarm Setup 2 must read "Alarm Mode: [OFF]")

<i>Channel</i>	Assign the relay to any analog or pulse input.
<i>High Value</i>	Enter high process variable set/reset point.
<i>Low Value</i>	Enter low process variable set/reset point.
<i>Delay ON</i>	Enter the delay between when the set point is reached and the relay turns on (energizes.)
<i>Delay OFF</i>	Enter the delay between when the reset point is reached and the relay turns off (de-energizes.)
<i>Link Relays</i>	Select between two and nine relays to operate in sequence.

Lead-Lag Override Function

Lead-Lag mode supports an override function, which allows up to five linked relays to turn on if programmed points are reached. Override set points also operate in sequence. They are not assigned to particular relays.

Use **OVER** key in Lead-Lag menu to access override menu.

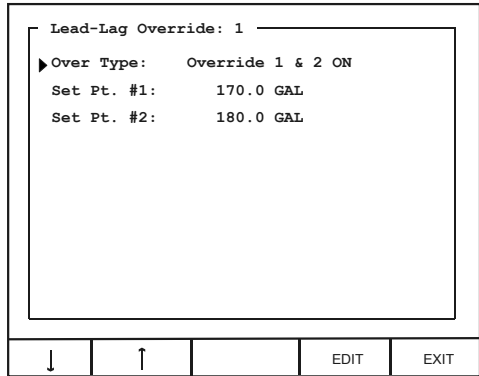

- Over Type** Choose number relays to override main relay (Up to 4 additional set points for a maximum of 5 relays operating at once.)
- Set Pt. #1 (#2, #3, #4)** Specify each process set point for the override relays to activate.

Example:

[LEAD-LAG: HIGH] is used to link relays #1, #2, and #3. In the Alarm Menu, *High Value* is set at 160.0 GAL and *Low Value* is set at 8.0 GAL. In the Override Menu, *Over Type* is set to [Override 1 & 2 ON.] *Set Pt. #1* is set to 170.0 GAL and *Set Pt. #2* is set to 180.0 GAL.

When the input reaches 160.0 GAL, the first relay in the sequence (Relay #1) turns on. When 170.0 GAL is reached, the next relay (Relay #2) turns on. If at this point the input decreases and drops below 8.00 GAL, both relays will turn OFF simultaneously. If instead, the input reaches 180.0 GAL, the third relay will turn ON and all three will remain ON until 8.0 GAL has been reached.

Note: In most override applications the number of relays linked should equal the total number of set points. However, linking additional relays is allowed. In the example, if 5 relays were linked and the total set points remained at 3, it would only be possible for 3 of the 5 to be on at once, but all 5 would sequence.

Linear Pulse Width Modulation Mode

Linear PWM Mode is used to create an on/off pulse signal with a modulated duty cycle. In this mode the percentage of the relay cycle in which the relay is in the on state varies with relation to the process value.

See **Figure 21** for an example showing that the cycle time (period) remains the same, but the relay-on percentage of the cycle changes with the process value.

Select [PWM: Linear] from *Alarm Mode* options to modulate the pulse relay signal in linear mode.

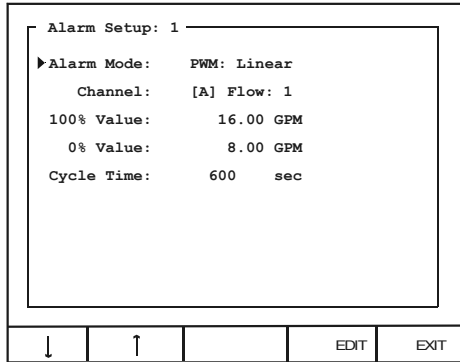

<i>Channel</i>	Assign the relay to any analog or pulse input.
<i>100% Value</i>	Enter the process value at which the pulse width will be 100% of cycle.
<i>0% Value</i>	Enter the process value at which the pulse width will be 0% of cycle.
<i>Cycle Time</i>	Enter the period for 1 cycle (maximum 6550 sec.)

Note 1: Due to the life expectancy of mechanical relays, it is strongly recommended that cycle times be as long as possible (many minutes.) Using a cycle time of less than a few minutes can wear out a relay and cause faulty operation.
 Note 2: Relay is a constant OFF when process variable is at or below 10% of full span and a constant ON when process variable is at or above 90% of full span to prevent abrupt switching from occurring and causing damage to relays.

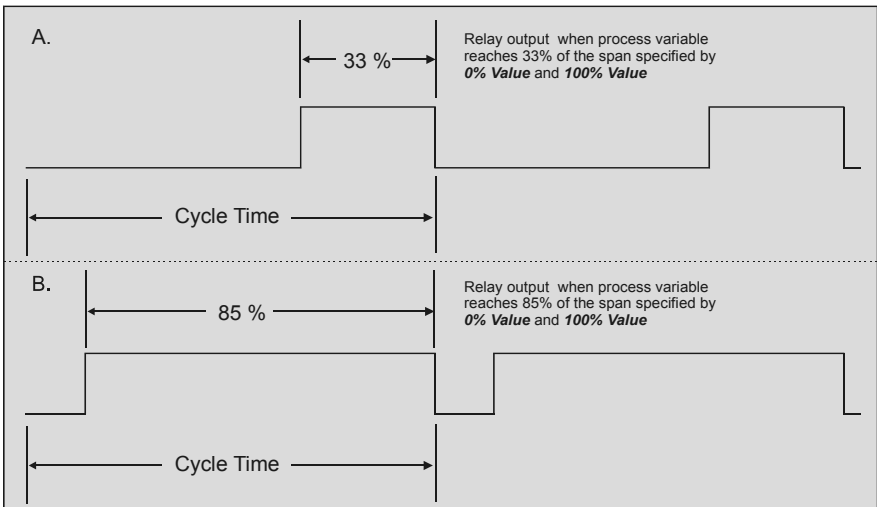

Figure 21. Linear PWM Relay Timing Example

Proportional Plus Integral Pulse Width Modulation Mode

PWM PI Control Mode is used to create an on/off pulse signal with a duty cycle modulated by the proportional integral settings. In this mode the percentage of the relay cycle in which the relay is in the on state varies with relation to the process value feedback and the PI settings.

Alarm Setup: 1	
▶ Alarm Mode:	PWM: PI Control
Feedbk Ch:	[A] Flow: 1
Set Point:	12.00 GPM
Prop. Gain:	32.0 %
Int. Time:	0.1 sec / rpt
Cycle Time:	1 sec
Rly Period:	600 sec
Int. Limit:	1.0 %
Inc / Dec:	Increasing
↓	↑
	EDIT
	EXIT

- Set Point* Enter the process target.
- Feedbk Ch* Select an analog input to supply the feedback signal from the system.
- Prop. Gain* Enter the proportional gain expressed as a percentage.
- Int. Time* Enter the integral time expressed as seconds per repeat.
- Cycle Time* Enter the PI calculation cycle time (Low number for fast-responding systems, high number for slow-responding systems.)
- Rly Period* Enter a relay period.
- Int. Limit* Specify the integration limit as a percentage (Limits integral influence on the output.)
- Inc / Dec* Select either [Increasing] or [Decreasing].

Note: Due to the life expectancy of mechanical relays, it is strongly recommended that cycle times be as long as possible (many minutes.) Using a cycle time of less than a few minutes can wear out a relay and cause faulty operation.

Setting 4-20 mA Outputs

The Analog Output menu is used to configure the 4-20 mA outputs. Each output has a separate screen. All 4-20 mA outputs can be configured using the information provided in this section.

Linear Scaling of 4-20 mA Output

Select [LINEAR] from *Mode* options to set the analog output for a linear scale from 4 to 20 mA.

Example: If 4 mA Val is set to 10 gal and 20 mA Val is set to 30 gal, when the input reads 10 gal, 4 mA will be transmitted out. When the input reads 20 gal, 12 mA will be transmitted out, and when the input reads 30 gal, 20 mA will be transmitted out.

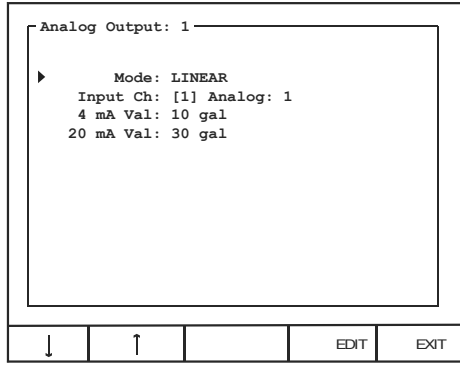

- Input Ch* Assign the output to any 4-20 mA or pulse input. Note that more than one output can be scaled from the same input by simply choosing that channel in another Analog Output.
- 4 mA Val* Enter the low process level that will result in a 4 mA signal transmission.
- 20 mA Val* Enter the high process level that will result a 20 mA signal transmission.

PID Control Using 4-20 mA Output

To set the analog output for PID control, select [PID CONTROL] from *Mode* options.

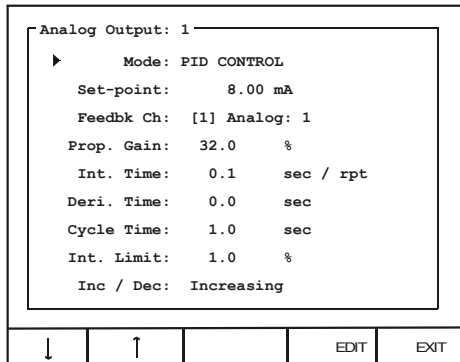

- Set Point* Enter the process target.
- Feedbk Ch* Select an analog input to supply the feedback signal from the system.
- Prop. Gain* Enter the proportional gain expressed as a percentage.
- Int. Time* Enter the integral time expressed as seconds per repeat.
- Deri. Time* Enter the derivative time in seconds.
- Cycle Time* Enter the PID calculation cycle time (Low number for fast-responding systems, high number for slow-responding systems.)
- Int. Limit* Specify the integration limit as percentage (Limits integral influence on the output.)
- Inc / Dec* Select either [Increasing] or [Decreasing].

OPERATION

Viewing Screens

The instrument displays various screens with bargraphs, numerical values, and relay status throughout operation. There are two basic modes of operation: Automatic, which allows the controller to function based on it's programmed settings; and Manual mode, which disables all automatic output functions. The controller initializes in Automatic mode. When manual mode is entered, all outputs are suspended or frozen in their current state so that they can only be changed manually. Although, totalization continues while in Manual mode. The example screens that follow can be viewed in all modes of operation with only subtle differences noticeable including button names and headings.

Relay Status Screen

To the right is an example of a Relay Status screen as it would appear in Automatic mode. The screen displays the current state of the relay, the total time the relay has spent in the ON state and how many times the relay has cycled from OFF to ON. In Manual mode, this screen allows for overriding the relays and resetting the Hours and Cycles counts. This is discussed further in **Manual Relay Control** (page 45.)

Relay Status:		
	<u>Hours</u>	<u>Cycles</u>
Relay #1: ON	10.2	320
Relay #2: OFF	215.0	566
Relay #3: OFF	197.6	512
Relay #4: ON	175.2	490
Relay #5: OFF	121.7	251
Relay #6: OFF	255.1	357
Relay #7: ON	11.7	22
Relay #8: ON	143.6	30
Relay #9: OFF	412.5	197

SETUP	AUTO		ACK	NEXT
-------	------	--	-----	------

- SETUP** Press to enter setup menu (Password restricted).
- AUTO / MANUAL** The **AUTO** key indicates the unit is in Automatic mode. Press it to switch to Manual mode. Press **NEXT** to return to main screen. Once in Manual mode press **MANUAL** to switch to Automatic mode.
Note: The **AUTO / MANUAL** modes are password restricted.
- ACK** Press to acknowledge (reset) the relays assigned to *Supervisory*, *Summary* or *Annunciator Alarm* functions and to silence the buzzer.
- NEXT** Press to scroll to the next operation screen.

Multiple Channel Operation Screen

To the right is an example of a multiple channel operation screen for a four input application. The screen reflects all of the inputs that were detected or enabled during setup. Depending on the actual number of inputs in use, this screen will adjust its size and proportions automatically.

Note: It is recommended not to exceed 8 channels or graphics may overlap.

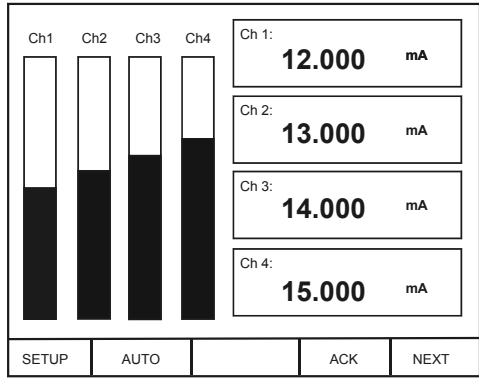

SETUP

Press to enter setup menu (Password restricted).

AUTO / MANUAL

The **AUTO** key indicates the unit is in Automatic mode. Press it to switch to Manual mode. Press **NEXT** to return to main screen. Once in Manual mode press **MANUAL** to switch to Automatic mode.

Note: The **AUTO / MANUAL** modes are password restricted.

ACK

Press to acknowledge (reset) the relays assigned to *Supervisory*, *Summary* or *Annunciator Alarm* functions and to silence the buzzer.

NEXT

Press to scroll to the next operation screen.

Single Analog Input Operation Screen

For each analog input channel, there is a detailed individual channel operation screen, which shows a bargraph with relay set points, numerical values, sensor input, and relay status for the relays assigned to that particular channel.

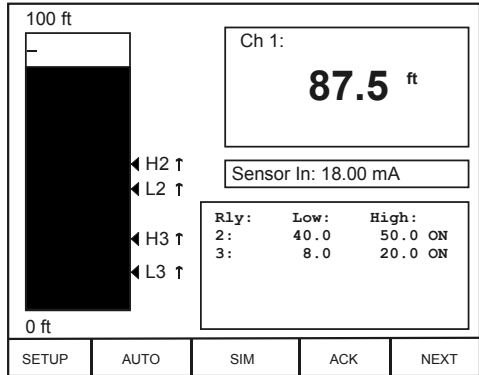

SETUP

Press to enter setup menu (Password restricted).

AUTO / MANUAL

The **AUTO** key indicates the unit is in Automatic mode. Press it to switch to Manual mode. Press **NEXT** to return to main screen. Once in Manual mode press **MANUAL** to switch to Automatic mode.

Note: The **AUTO / MANUAL** modes are password restricted.

SIM / RST

Press to enter a simulation mode where the input can be adjusted manually. (Password restricted.) If the channel is set for Integration totalizing, the **SIM** key is replaced by **RST**, which is used to reset the total to zero (Password restricted.)

ACK

Press to acknowledge (reset) the relays assigned to *Supervisory*, *Summary* or *Annunciator Alarm* functions and to silence the buzzer.

NEXT

Press to scroll to the next operation screen.

Single Flow Meter Pulse Input Operation Screen

For each flow meter pulse input channel, there is a detailed individual channel operation screen, which shows a bargraph with relay set points, numerical values for rate and total, and relay status for the relays assigned to that particular channel. This screen may also be set to show a bargraph for rate rather than total. See **Setting Flow Meter Pulse Inputs** (page 30.)

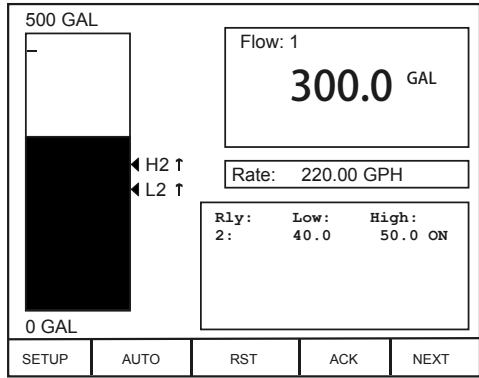

- SETUP** Press to enter setup menu (Password restricted).
- AUTO / MANUAL** The **AUTO** key indicates the unit is in Automatic mode. Press it to switch to Manual mode. Press **NEXT** to return to main screen. Once in Manual mode press **MANUAL** to switch to Automatic mode.
Note: The **AUTO / MANUAL** modes are password restricted.
- RST** Use this key to reset the total to zero (Password restricted.)
- ACK** Use to acknowledge (reset) the relays assigned to *Supervisory*, *Summary* or *Annunciator Alarm* functions and to silence the buzzer.
- NEXT** Use this key to scroll to the next operation screen.

Digital Input Operation Screen

The Digital Input screen shows the states of the digital inputs. *ON* is shown when a switch connected to the input is closed or when an open collector transistor is conducting. *OFF* is shown when the switch is open or when the open collector transistor is not conducting.

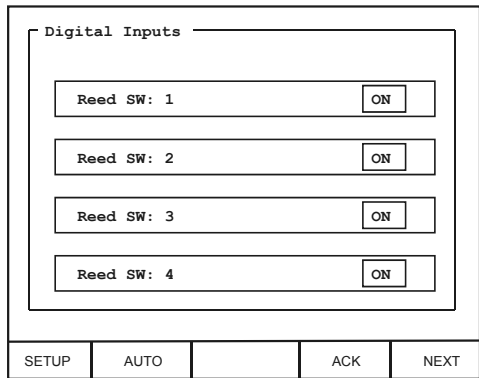

- SETUP** Press to enter setup menu (Password restricted).
- AUTO / MANUAL** The **AUTO** key indicates the unit is in Automatic mode. Press it to switch to Manual mode. Press **NEXT** to return to main screen. Once in Manual mode press **MANUAL** to switch to Automatic mode.
Note: The **AUTO / MANUAL** modes are password restricted.
- ACK** Use to acknowledge (reset) the relays assigned to *Supervisory*, *Summary* or *Annunciator Alarm* functions and to silence the buzzer.
- NEXT** Use this key to scroll to the next operation screen.

Analog Input Numeric Screen

To the right is an example of an analog numeric summary screen for an eight input application. It shows a box for each channel with the sensor input in mA on the bottom and the scaled engineering units on top. The screen reflects all of the inputs that were detected.

Note: The total is displayed as the engineering value when that channel is set for Integration mode.

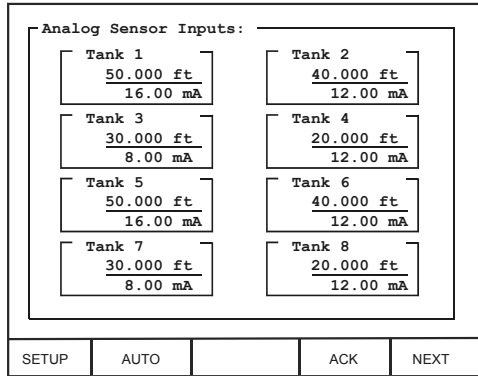

SETUP

Press to enter setup menu (Password restricted).

AUTO / MANUAL

The **AUTO** key indicates the unit is in Automatic mode. Press it to switch to Manual mode. Press **NEXT** to return to main screen. Once in Manual mode press **MANUAL** to switch to Automatic mode.

Note: The **AUTO / MANUAL** modes are password restricted.

ACK

Press to acknowledge (reset) the relays assigned to *Supervisory*, *Summary* or *Annunciator Alarm* functions and to silence the buzzer.

NEXT

Press to scroll to the next operation screen.

Flow Meter Numeric Screen

To the right is an example of a flow meter numeric summary screen. It shows a box for each flow channel with the input frequency, flow and total.

Note: The total is displayed as the engineering value when that channel is set for Integration mode.

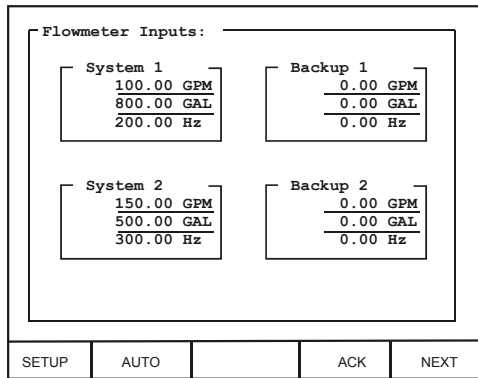

SETUP

Press to enter setup menu (Password restricted).

AUTO / MANUAL

The **AUTO** key indicates the unit is in Automatic mode. Press it to switch to Manual mode. Press **NEXT** to return to main screen. Once in Manual mode press **MANUAL** to switch to Automatic mode.

Note: The **AUTO / MANUAL** modes are password restricted.

ACK

Press to acknowledge (reset) the relays assigned to *Supervisory*, *Summary* or *Annunciator Alarm* functions and to silence the buzzer.

NEXT

Press to scroll to the next operation screen.

Manual and Simulation Modes

When manual mode is entered, all outputs are suspended or frozen in their current state until they are changed manually, although totalization continues while in Manual mode.

For example: Relay #1 is programmed to activate a pump based on the level of Channel #1. If the activation level is reached, and the pump is turned on, it will remain active through the transition from Automatic to Manual. In Manual mode, the relay will not respond to changes in the Channel #1 level even if it goes below a programmed reset point. The operator has complete control over each relay's state and must turn Relay #1 off by doing so in the Manual Relay Control Screen (shown below on this page.)

Accordingly, when transitioning from Manual to Automatic Mode, the controller scans the inputs and updates output status ignoring changes to relay status while in Manual mode. However, if the setup and programming of the controller was modified during Manual mode, these changes take effect the moment the controller re-enters Automatic mode. You may choose to disable outputs while reprogramming by entering Manual mode.

Manual Relay Control

To the right is an example of a Manual Relay Control screen as it appears in Manual mode. The screen displays the current state of the relay, the total time the relay has spent in the ON state and how many times the relay has cycled from OFF to ON. In Manual mode, this screen allows for overriding the relays and resetting the *Hours* and *Cycles* counts.

Manual Mode		
	Hours	Cycles
► Relay #1: ON	10.2	320
Relay #2: OFF	215.0	566
Relay #3: OFF	197.6	512
Relay #4: ON	175.2	490
Relay #5: OFF	121.7	251
Relay #6: OFF	255.1	357
Relay #7: ON	11.7	22
Relay #8: ON	143.6	30
Relay #9: OFF	412.5	197

↓
↑
OFF
RESET
NEXT

- ↑, ↓ Move cursor up or down one relay.
- ON / OFF Press to turn selected relay on or off.
- RESET Press to reset *Hours* and *Cycles* counts for selected relay.
- NEXT/EXIT Press to scroll to the next operation screen.

Simulation Mode

To the right is an example of an analog input Simulation screen. Simulation is accessible to each analog input individually.

Simulation mode may be accessed while operating in Automatic mode or Manual mode. When in Automatic mode, all outputs respond to the simulation as programmed for normal operation. During Manual mode, changing the settings has no effect on outputs.

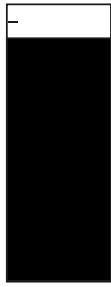
<div style="text-align: center;">100 ft</div>  <div style="text-align: center;">0 ft</div>	<div style="border: 1px solid black; padding: 5px; margin-bottom: 5px;">Ch 1:</div> <div style="text-align: center; font-size: 24pt; font-weight: bold;">87.5 ft</div> <div style="border: 1px solid black; padding: 2px; margin-bottom: 5px;">Sensor In: 18.00 mA</div> <table border="1" style="width: 100%; border-collapse: collapse;"> <tr> <td>Rly:</td> <td>Low:</td> <td>High:</td> </tr> <tr> <td>2:</td> <td>40.0</td> <td>50.0 ON</td> </tr> <tr> <td>3:</td> <td>8.0</td> <td>20.0 ON</td> </tr> </table>	Rly:	Low:	High:	2:	40.0	50.0 ON	3:	8.0	20.0 ON
Rly:	Low:	High:								
2:	40.0	50.0 ON								
3:	8.0	20.0 ON								
+ -	EXIT									

- + , - Increase or decrease level.
- EXIT Press to exit Simulation mode.

Contrast Adjustment Control

All ConsoliDators are adjusted at the factory for optimal viewing. If additional adjustment is needed, use the contrast adjustment potentiometer located on the left side of the case, next to the DC POWER connector.

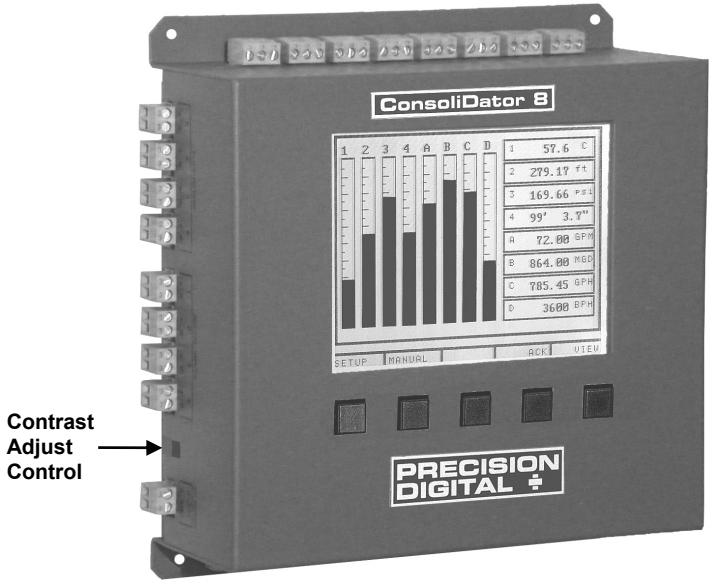

Contrast Adjust Control

MODBUS® SERIAL COMMUNICATION

The controller is equipped with serial communication capability as a standard feature. Baud Rate, Parity, Modbus ID (Address) and Transmit Delay are entered in the *General Functions* box, which appears in the main setup menu. The baud rate and parity selected must match the settings for all other devices on the network. Modbus ID must be unique so it will not interfere with other devices.

ConsoliDators support the following Modbus control functions:

Command	Name	Description
03	Read Holding Register	Read multiple bytes from holding registers.
05	Write Single Coil	Set single coil value control
06	Write Single Register	Set single value into specified holding register.
16	Write Multiple Registers	Set multiple values into specified holding registers.

Note: To save data to non-volatile memory after changing the contents of holding register(s) use the Write Single Coil command [command code 05] to "ON" at address 64251.

To control the relays via MODBUS you would use the Write Single Coil command [command code 05] and send either the "ON" or "OFF" to the appropriate alarm relay (1-9).

The ConsoliDator can also work as a "MODBUS Display" by setting the desired analog input channel to the "FIXED" type and then over MODBUS change the "K-Factor/Modbus Display" value for the corresponding channel. This input type is transparent to the rest of the functions of the unit (i.e. relays, etc...). The value, once the EEPROM save command is sent to the unit, is also maintained in EEPROM after the next power cycle.

Modbus Register Tables

Table 1. Analog Output Channels Register Addresses

Address (offset from 40000)				Description	Data Type
Ch. 1	Ch. 2	Ch. 3*	Ch. 4*		
801	819	837	855	4 mA Value	Floating Point
802	820	838	856		
803	821	839	857	20 mA Value	Floating Point
804	822	840	858		
805	823	841	859	Set point Value	Floating Point
806	824	842	860		
807	825	843	861	PID KP	Floating Point
808	826	844	862		
809	827	845	863	PID KI	Floating Point
810	828	846	864		
811	829	847	865	PID KD	Floating Point
812	830	848	866		
813	831	849	867	PID Output Value	Floating Point
814	832	850	868		
815	833	851	869	PID Cycle Time	Integer
816	834	852	870	Output Type	Byte
817	835	853	871	Input Ch.	Byte
818	836	854	872	PID Direction	Byte

*Channels 3-4 only apply to ConsoliDator 4 (PD940 & PD941) models.

Table 2. Analog Input Channels Register Addresses

Address (offset from 40000)								Description	Data Type
Ch. 1	Ch. 2	Ch. 3	Ch. 4	Ch. 5*	Ch. 6*	Ch. 7*	Ch. 8*		
1	33	65	97	129	161	193	225	Engineering Value	Floating Point
2	34	66	98	130	162	194	226		
3	35	67	99	131	163	195	227	Max. Graph Value	Floating Point
4	36	68	100	132	164	196	228		
5	37	69	101	133	165	197	229	Min. Graph Value	Floating Point
6	38	70	102	134	166	198	230		
7	39	71	103	135	167	199	231	High Value	Floating Point
8	40	72	104	136	168	200	232		
9	41	73	105	137	169	201	233	High Value mA	Floating Point
10	42	74	106	138	170	202	234		
11	43	75	107	139	171	203	235	Low Value	Floating Point
12	44	76	108	140	172	204	236		
13	45	77	109	141	173	205	237	Low Value mA	Floating Point
14	46	78	110	142	174	206	238		
15	47	79	111	143	175	207	239	Decimal Format	Byte
16	48	80	112	144	176	208	240	Ch. Online Flag	Byte
17	49	81	113	145	177	209	241	Ch. ID Char. 1	Byte
18	50	82	114	146	178	210	242	Ch. ID Char. 2	Byte
19	51	83	115	147	179	211	243	Ch. ID Char. 3	Byte
20	52	84	116	148	180	212	244	Ch. ID Char. 4	Byte
21	53	85	117	149	181	213	245	Ch. ID Char. 5	Byte
22	54	86	118	150	182	214	246	Ch. ID Char. 6	Byte
23	55	87	119	151	183	215	247	Ch. ID Char. 7	Byte
24	56	88	120	152	184	216	248	Ch. ID Char. 8	Byte
25	57	89	121	153	185	217	249	Ch. ID Char. 9	Byte
26	58	90	122	154	186	218	250	Ch. ID Char. 10	Byte
27	59	91	123	155	187	219	251	Units Character 1	Byte
28	60	92	124	156	188	220	252	Units Character 2	Byte
29	61	93	125	157	189	221	253	Units Character 3	Byte
1523	1547	1571	1595	1619	1643	1667	1691	Function Mode**	Byte
1901	1911	1921	1931	1941	1951	1961	1971	K-Factor / Modbus Display	Floating Point
1902	1912	1922	1932	1942	1952	1962	1972		
1903	1913	1923	1933	1943	1953	1963	1973	Offset	Floating Point
1904	1914	1924	1934	1944	1954	1964	1974		
1905	1915	1925	1935	1945	1955	1965	1975	Conversion #1	Floating Point
1906	1916	1926	1936	1946	1956	1966	1976		
1907	1917	1927	1937	1947	1957	1967	1977	Conversion #2	Floating Point
1908	1918	1928	1938	1948	1958	1968	1978		
1909	1919	1929	1939	1949	1959	1969	1979	Channel Linking	Byte
1910	1920	1930	1940	1950	1960	1970	1980	Function Channel	Byte

*Channels 5-8 only apply to ConsoliDator 8 (PD980 & PD981) models.

**Function Mode Byte Values:

Byte = 0: Linear

Byte = 48: Summation

Byte = 96: Fixed/Modbus Display

Byte = 144: Integration – Hour

Byte = 16: Square Root

Byte = 64: Exponent

Byte = 112: Integration – Sec

Byte =160: Integration – Day

Byte = 32: Difference

Byte = 80: Multi-Point

Byte =128: Integration – Min

Table 3. Flow Meter Pulse Input Channels Register Addresses

Address (offset from 40000)				Description	Data Type
Ch. 1	Ch. 2	Ch. 3	Ch. 4		
261	291	321	351	Flow Meter Rate	Floating Point
262	292	322	352		
263	293	323	353	Flow Meter Total	Floating Point
264	294	324	354		
265	295	325	355	K Factor	Floating Point
266	296	326	356		
267	297	327	357	Maximum Graph Value	Floating Point
268	298	328	358		
269	299	329	359	Flow Meter Previous Total	Floating Point
270	300	330	360		
271	301	331	361	Rate Decimal Format	Byte
272	302	332	362	Total Decimal Format – Upper 4 bits K Factor Decimal Format – Lower 4 bits	Byte
273	303	333	363	Ch. Online Flag	Byte
274	304	334	364	Display Format (Rate or Total)	Byte
275	305	335	365	Ch. ID Character 1	Byte
276	306	336	366	Ch. ID Character 2	Byte
277	307	337	367	Ch. ID Character 3	Byte
278	308	338	368	Ch. ID Character 4	Byte
279	309	339	369	Ch. ID Character 5	Byte
280	310	340	370	Ch. ID Character 6	Byte
281	311	341	371	Ch. ID Character 7	Byte
282	312	342	372	Ch. ID Character 8	Byte
283	313	343	373	Ch. ID Character 9	Byte
284	314	344	374	Ch. ID Character 10	Byte
285	315	345	375	Rate Units Character 1	Byte
286	316	346	376	Rate Units Character 2	Byte
287	317	347	377	Rate Units Character 3	Byte
288	318	348	378	Total Units Character 1	Byte
289	319	349	379	Total Units Character 2	Byte
290	320	350	380	Total Units Character 3	Byte

Table 4. Digital Input Channels Register Addresses

Address (offset from 40000)				Description	Data Type
Ch. 1	Ch. 2	Ch. 3	Ch. 4		
401	413	425	437	Digital State	Byte
402	414	426	438	Inversion State	Byte
403	415	427	439	Ch. ID Character 1	Byte
404	416	428	440	Ch. ID Character 2	Byte
405	417	429	441	Ch. ID Character 3	Byte
406	418	430	442	Ch. ID Character 4	Byte
407	419	431	443	Ch. ID Character 5	Byte
408	420	432	444	Ch. ID Character 6	Byte
409	421	433	445	Ch. ID Character 7	Byte
410	422	434	446	Ch. ID Character 8	Byte
411	423	435	447	Ch. ID Character 9	Byte
412	424	436	448	Ch. ID Character 10	Byte

Table 5. Relay Channels Register Addresses

Address (offset from 40000)									Description	Data Type
Rly. 1	Rly. 2	Rly. 3	Rly. 4	Rly. 5	Rly. 6	Rly. 7	Rly. 8	Rly. 9		
461	493	525	557	589	621	653	685	717	Alarm High Set point	Floating Pt.
462	494	526	558	590	622	654	686	718		
463	495	527	559	591	623	655	687	719	Alarm Low Set Point	Floating Pt.
464	496	528	560	592	624	656	688	720		
465	497	529	561	593	625	657	689	721	Alarm K Factor	Floating Pt.
466	498	530	562	594	626	658	690	722		
467	499	531	563	595	627	659	691	723	Alarm Diff-Pressure	Floating Pt.
468	500	532	564	596	628	660	692	724		
469	501	533	565	597	629	661	693	725	Relay ON Time	Floating Pt.
470	502	534	566	598	630	662	694	726		
471	503	535	567	599	631	663	695	727	Relay Cycles	Floating Pt.
472	504	536	568	600	632	664	696	728		
473	505	537	569	601	633	665	697	729	Delay On Time	Byte
474	506	538	570	602	634	666	698	730	Delay Off Time	Byte
475	507	539	571	603	635	667	699	731	Pulse On Time	Byte
476	508	540	572	604	636	668	700	732	Pulse Off Time	Byte
477	509	541	573	605	637	669	701	733	After Flow Time	Byte
478	510	542	574	606	638	670	702	734	Alarm Type	Byte
479	511	543	575	607	639	671	703	735	Alarm Ch.	Byte
480	512	544	576	608	640	672	704	736	Alarm Sec. Ch.	Byte
481	513	545	577	609	641	673	705	737	Alarm Dig. Ch.	Byte
482	514	546	578	610	642	674	706	738	Alarm ON/OFF Flag	Byte
483	515	547	579	611	643	675	707	739	Relay State Flag	Byte
484	516	548	580	612	644	676	708	740	Relay Assign Flag	Byte
485	517	549	581	613	645	677	709	741	Alarm PWM Output	Floating Pt.
486	518	550	582	614	646	678	710	742		
487	519	551	583	615	647	679	711	743	Alarm PID Set Pt.	Floating Pt.
488	520	552	584	616	648	680	712	744		
489	521	553	585	617	649	681	713	745	Alarm PID KP Setting	Integer
490	522	554	586	618	650	682	714	746	Alarm PID KI Setting	Integer
491	523	555	587	619	651	683	715	747	Alarm PID I Band	Integer
492	524	556	588	620	652	684	716	748	Alarm PID Direction	Byte
1351	1361	1371	1381	1391	1401	1411	1421	1431	Override Value #1*	Floating Pt.
1352	1362	1372	1382	1392	1402	1412	1422	1432		
1353	1363	1373	1383	1393	1403	1413	1423	1433	Override Value #2*	Floating Pt.
1354	1364	1374	1384	1394	1404	1414	1424	1434		
1355	1365	1375	1385	1395	1405	1415	1425	1435	Override Value #3*	Floating Pt.
1356	1366	1376	1386	1396	1406	1416	1426	1436		
1357	1367	1377	1387	1397	1407	1417	1427	1437	Override Value #4*	Floating Pt.
1358	1368	1378	1388	1398	1408	1418	1428	1438		
1359	1369	1379	1389	1399	1409	1419	1429	1439	Override Mode*	Byte

*Override Mode Byte Values:
 Byte Value = 0: OFF (No overrides)
 Byte Value = 1: Input > SP with High Alarm
 Byte Value = 2: Input > SP with Low Alarm
 Byte Value = 3: Input > SP with Alarm OFF
 Byte Value = 4: Input < SP with High Alarm
 Byte Value = 5: Input < SP with Low Alarm
 Byte Value = 6: Input < SP with Alarm OFF

*Override Mode Programming:
 Override Value #1 is the Set Point for Override.
 Override Value #2 is the High Value Alarm Set Point.
 Override Value #3 is the Low Value Alarm Set Point.
 Override Value #4 is N/A.

Table 6. Analog Inputs, Flow meter, and Relay State Summary

Address (offset from 40000)	Description	Data Type
751	Analog Channel #1 Engineering Value	Floating Point
752	(Rate value during integration mode.)	
753	Analog Channel #2 Engineering Value	Floating Point
754	(Rate value during integration mode.)	
755	Analog Channel #3 Engineering Value	Floating Point
756	(Rate value during integration mode.)	
757	Analog Channel #4 Engineering Value	Floating Point
758	(Rate value during integration mode.)	
759	Analog Channel #5 Engineering Value	Floating Point
760	(Rate value during integration mode.)	
761	Analog Channel #6 Engineering Value	Floating Point
762	(Rate value during integration mode.)	
763	Analog Channel #7 Engineering Value	Floating Point
764	(Rate value during integration mode.)	
765	Analog Channel #8 Engineering Value	Floating Point
766	(Rate value during integration mode.)	
769		
770	Flow Meter Rate #1	Floating Point
771		
772	Flow Meter Total #1	Floating Point
773		
774	Flow Meter Rate #2	Floating Point
775		
776	Flow Meter Total #2	Floating Point
777		
778	Flow Meter Rate #3	Floating Point
779		
780	Flow Meter Total #3	Floating Point
781		
782	Flow Meter Rate #4	Floating Point
783		
784	Flow Meter Total #4	Floating Point
785		
786	Alarm State #1	Byte
787	Alarm State #2	Byte
788	Alarm State #3	Byte
789	Alarm State #4	Byte
790	Alarm State #5	Byte
791	Alarm State #6	Byte
792	Alarm State #7	Byte
793	Alarm State #8	Byte
	Alarm State #9	Byte

This register group is designed for convenient access to status readings.

CONSOLIDATOR MONITOR SOFTWARE

Each ConsoliDator is shipped with PC software on CD-ROM, which supports monitoring, data logging and controller setup/programming. You may also download this software from the web at www.predig.com. There are separate versions of the software for 4-channel and 8-channel models.

Connecting to PC

Many computers are equipped with at least one 9-pin serial port compatible with RS-232. For distances up to approximately 50 ft, a null-modem cable is adequate. The null modem cable looks similar to a standard serial cable, except both ends are female, and the transmit and receive lines in the cable cross-over unlike a standard serial cable. Reference **Serial Communication Connections** (page 19) for more information.

Installing Software

Load the ConsoliDator Software CD-ROM into your CD-ROM drive. If the installation does not load automatically within a few moments, click on the Start button on the Windows® taskbar, then click **RUN**. Type `x:\ConsoliDator_Monitoring_System.exe` (where x is your actual CD-ROM drive letter) and press enter. Follow on-screen instructions.

Using ConsoliDator Monitor Software

Launch the program from the **Start** menu or desktop shortcut. Make sure you are using the correct version of the software for the number of channels your model has – 4 or 8. Verify the controller is powered up and properly connected before proceeding.

From the drop-down menu in the bottom left of the screen, select the *Modbus ID* that matches the same setting in the controller. Default is *Modbus ID: 1*. Click the **Connect** button in the lower left of the screen and allow a moment for the software to read data in.

Window tabs above the bargraphs navigate the various channel displays available. The screen in the top right is active when the *View All Channels* tab is selected. It shows all Analog Input bargraphs and numeric values along with Relay and Digital Input status. This information represents *real time* data sent from the controller.

Selecting a tab for a specific channel brings a chart of the style shown in the bottom right. The charts show a graphical history for each Analog Input channel along with its *real time* bargraph and numeric value. There is also a tab for the flow meter pulse input channels, which shows numeric total and numeric and bargraph rate for all flow channels.

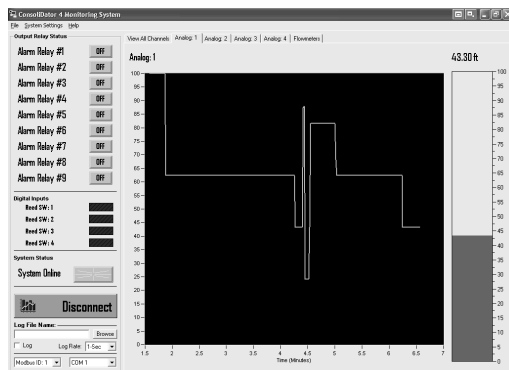
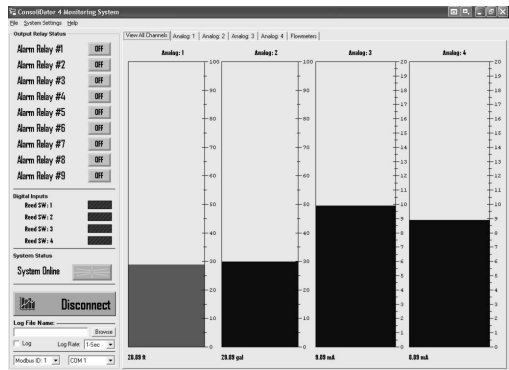

Data Logging

The software supports logging input readings to a comma separated value file (*.csv) compatible with spreadsheet applications. Log settings appear in the lower left of the screen. First, specify a time interval from the *Log Rate* options. Note that small intervals will result in a large file size. If logging for long periods such as days or weeks at a time, it is suggested that intervals be in the minute or greater range. Next, supply a name in *Log File Name* box and click **Browse** to specify a location to save the file. Lastly, select the *Log* checkbox. To view the data, launch your spreadsheet application and open or *import* the file. Some spreadsheet applications such as Microsoft® Excel have a chart wizard or other tool that will create presentable graphs and trend lines of your data.

Programming Through Software

The software supports programming of most functions available to the controller. Not included are some of the *General Functions* which must be setup on the device itself through the front buttons. This section is limited to serving as an overview of programming through software, because the parameters in the software menus correspond to the parameters on the controller's setup screens. You will need to follow the **Setup and Programming** section (page 21) to understand these parameters. Settings programmed through software will automatically be updated to the controller and be visible and accessible in the setup menus of the device.

To begin setup, select **System Settings** from the menu bar at the top of the screen. You will see the window shown to the right. From the drop-down menus in this window you can access settings for all inputs, alarms, and outputs.

When functions have been configured and loaded to the controller, you can choose to store the settings (configuration) file to your computer using the **Export Settings** button. The file may be used later to restore the configuration or to create a cloned copy ConsoliDator of the same model type. You may even take advantage of this to create multiple configurations modes and load them as necessary. To write the settings file to a ConsoliDator, simply click **Import Settings** and select the (*.set) file you would like to import to the controller's non-volatile system memory.



OVERALL DIMENSIONS

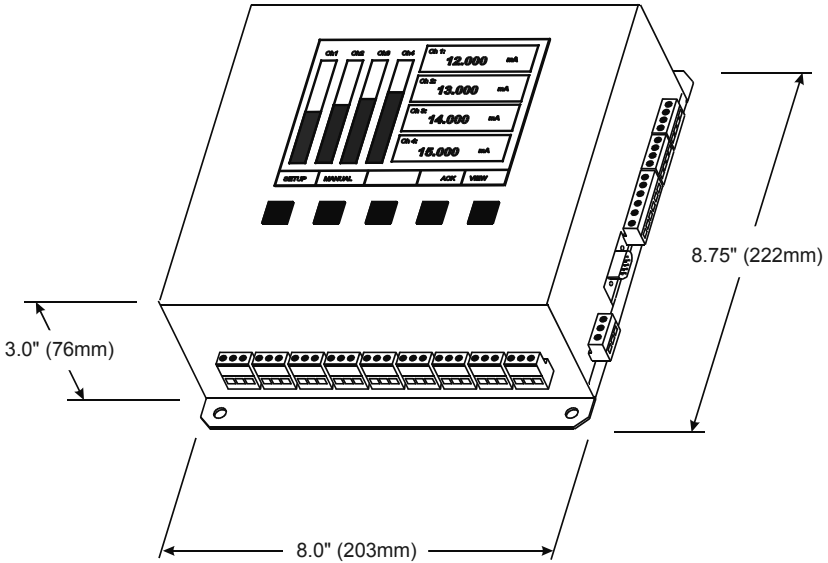

Figure 22. PD980 & PD940 Overall Dimensions

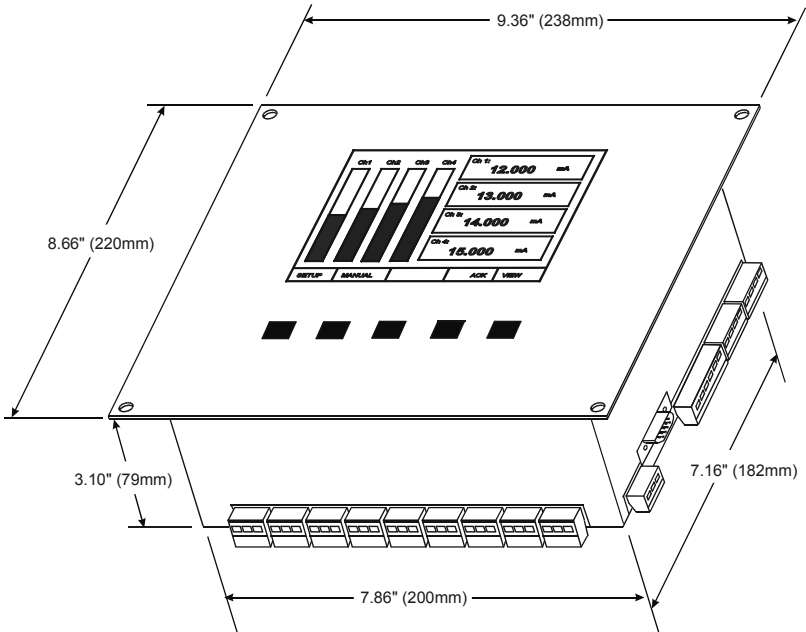

Figure 23. PD981 & PD941 Overall Dimensions

TROUBLESHOOTING TIPS

Symptom	Check/Action
No display, or only backlight is visible, but outputs still function normally.	<ol style="list-style-type: none"> 1. Contrast is too light: Adjust contrast in main setup menu. 2. Ambient temperature is below 0°C and affects LCD visibility: Adjust contrast to compensate. 3. High levels of radiated interference are present. Steps must be taken to shield controller from interference or to reduce interference present. Inductive loads are a possible source of interference. Reference Switching Inductive Loads (page 18.) 4. Grounding is inadequate or not connected. Check earth ground continuity.
Periodic hard resets (power cycling) or Supervisory alarms.	<ol style="list-style-type: none"> 1. High levels of radiated interference are present. Steps must be taken to shield controller from interference or to reduce interference present. Inductive loads are a possible source of interference. Reference Switching Inductive Loads (page 18.) 2. Grounding is inadequate or not connected. Check earth ground continuity.
“NO SENSORS FOUND” is displayed, but sensors are connected and transmitting.	Allow controller to warm-up for 10 or more minutes. If sensors still not detected, cycle the power to reboot.
Display response seems slower than normal	Ambient temperature is too cold: Consider installing a heater with the instrument.
Display locks up or the instrument does not respond at all	Cycle the power to reboot the microprocessor.
Settings reprogrammed, but instrument behavior remains as previously programmed	Cycle the power to reboot the microprocessor.
Relay and status do not respond to signal	<ol style="list-style-type: none"> 1. Meter must be in Automatic mode in order for relays to respond to signal. To enter this mode press the Manual key and follow the on-screen prompt. 2. Check Setup menu relay set and reset points.
Controller will not communicate serially with other device.	Check baud rates and parity settings. Make sure all serial devices have agreeing parameters.
Other symptoms not described above	Call Technical Support for assistance.

Model: _____

Serial Number: _____

Password: _____

How to Contact Precision Digital

- For Technical Support please

Call: (800) 610-5239 or (508) 655-7300

Fax: (508) 655-8990

E-mail: support@predig.com

- For Sales Support

Call: (800) 343-1001 or (508) 655-7300

Fax: (508) 655-8990

E-mail: sales@predig.com

- For the latest version of this Manual please visit:

www.predig.com



MICROWATT
Making Safety Work

Tollfree in Western Canada: 1-888-388-1592
microwatt.com • mwsales@microwatt.com